

DL1620/DL1640/DL1640L **Digital Oscilloscope**

U S E R ' S M A N U A L

Product Registration

Thank you for purchasing YOKOGAWA products.

YOKOGAWA provides registered users with a variety of information and services.

Please allow us to serve you best by completing the product registration form accessible from our homepage.

<http://tmi.yokogawa.com/>

Foreword

Thank you for purchasing the DL1620/DL1640/DL1640L Digital Oscilloscope. This user's manual contains useful information about the instrument's functions and operating procedures as well as precautions that should be observed during use, mainly DL1640. To ensure proper use of the instrument, please read this manual thoroughly before operating it. Keep the manual in a safe place for quick reference whenever a question arises.

Five manuals are provided with the instrument, including this user's manual.

Manual Name	Manual No.	Description
DL1620/DL1640/DL1640L User's Manual	IM 701610-01E	Describes all the functions (except for the communications function) and their operation procedures for the instrument.
DL1620/DL1640/DL1640L Communication Interface User's Manual (CD)	IM 701610-17E	Describes the communications functions of the GP-IB, RS-232, USB, and network interface.
DL1620/DL1640/DL1640L Operation Guide	IM 701610-02E	Explains basic operations only.
DL1640/DL1640L CAN Bus Signal Analysis Function	IM 701610-51E	Describes the CAN bus signal analysis function and SPI bus signal analysis function (option).
DL1640/DL1640L I ² C-Bus Signal Analysis Function	IM 701610-61E	Describes the I ² C-bus signal analysis function and SPI bus signal analysis function (option).

Notes

- The contents of this manual are subject to change without prior notice as a result of improvements in the instrument's performance and functions. Display contents illustrated in this manual may differ slightly from what actually appears on your screen.
- Every effort has been made in the preparation of this manual to ensure the accuracy of its contents. However, should you have any questions or find any errors, please contact your nearest YOKOGAWA representative.
- Copying or reproduction of all or any part of the contents of this manual without YOKOGAWA's permission is strictly prohibited.
- A guarantee card is attached to the instrument. The card will not be reissued, so please read it carefully and keep it in a safe place.
- The TCP/IP software used in this product and the documentation for that TCP/IP software are based in part on BSD Networking Software, Release 1 licensed from The Regents of the University of California.

Trademarks

- Internet Explorer, Microsoft, MS-DOS, Windows, Windows NT, Windows Me, and Windows XP are either registered trademarks or trademarks of Microsoft Corporation in the United States and/or other countries.
- Adobe, Adobe Acrobat, and PostScript are either trademarks or registered trademarks of Adobe Systems incorporated.
- Zip is a registered trademark or trademark of Iomega Corporation in the United States and/or other countries.
- UNIX is a registered trademark of The Open Group.
- For purposes of this manual, the TM and ® symbols do not accompany their respective trademark names or registered trademark names.
- Other product names are trademarks or registered trademarks of their respective holders.

Revisions

1st Edition:	August 2002
2nd Edition:	November 2002
3rd Edition:	February 2003
4th Edition:	August 2003
5th Edition:	December 2003
6th Edition:	July 2005
7th Edition:	October 2007
8th Edition:	April 2009

Checking the Contents of the Package

Unpack the box and check the contents before operating the instrument. If the wrong instrument or accessories have been delivered, if some accessories are missing or if they appear abnormal, contact the dealer from which you purchased them.

DL1620/DL1640/DL1640L Main Body

Check that the model name and suffix code given on the name plate of the side panel match those on your order. Whenever you contact the dealer from which you purchased the instrument, tell the dealer your unit's serial number.

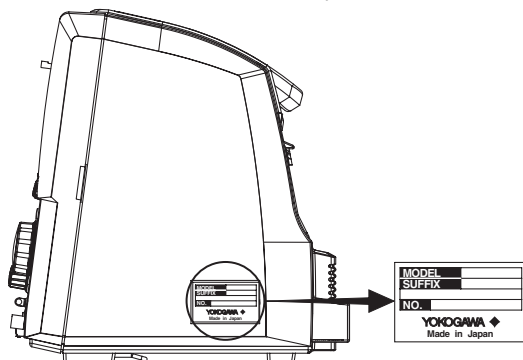

MODEL	SUFFIX	SPECIFICATIONS
701605 (DL1620)		2 channels
701610 (DL1640)		4 channels
701620 (DL1640L)		4 channels (long record length)
	-AC	100 to 120 VAC, 220 to 240 VAC
	-DC ^{*1}	12 VDC(for 701610 and 701620)
Power Cord	-D	UL/CSA standard power cord (A1006WD) Maximum rated voltage: 125 V, maximum rated current: 7 A
	-F	VDE standard power cord (A1009WD) Maximum rated voltage: 250 V, maximum rated current: 10 A
	-Q	BS standard power cord (A1054WD) Maximum rated voltage: 250 V, maximum rated current: 10 A
	-R	AS standard power cord (A1024WD) Maximum rated voltage: 250 V, maximum rated current: 10 A
	-H	GB standard power cord (A1064WD) Maximum rated voltage: 250 V, maximum rated current: 10 A
	-Y	No power cord
Built-in Media Drive	-J1	Floppy disk drive ^{*2}
	-J2	Zip disk drive ^{*1}
	-J3	PC card interface ^{*2}
Options	/B5	Built-in printer ^{*3}
	/C1	GP-IB interface+USB ^{*4}
	/C10	Ethernet interface+USB ^{*4}
	/P2	Two power output connectors for the probes (for 701605)
	/P4	Four power output connectors for the probes (for 701610 and 701620)
	/F5	I ² C-bus signal analyzer (for 701610 and 701620)
	/F7	CAN bus signal analyzer (for 701610 and 701620)

*1 Select -Y for the power Cord.

*2 You can select a floppy disk drive, a Zip drive, or PC card interface for the built-in media drive.

*3 1 printer roll (B9850NX) included.

*4 It is possible to choose between a GP-IB interface+USB and an Ethernet interface+USB.

Example : UL/CSA standard power cord, floppy disk drive, and full options

→ 701610-D-J1/B5/C1/P4 or

701610-D-J1/B5/C10/P4

Checking the Contents of the Package

NO. (Instrument Number)



When contacting the dealer from which you purchased your instrument, please quote the instrument number.

Standard Accessories

The following standard accessories are supplied with the instrument. Make sure that all items are present and undamaged.

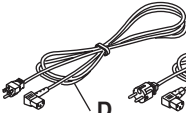
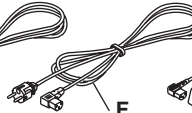
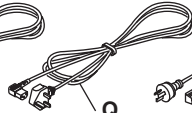
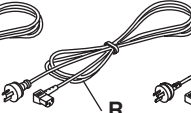
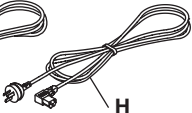
Power Cord (for -AC model) (one of the following power cords is supplied according to the instrument's suffix codes)

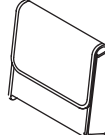
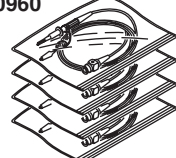
UL/CSA Standard A1006WD	VDE Standard A1009WD	BS Standard A1054WD	AS Standard A1024WD	GB Standard A1064WD	DC Power Supply Connector (for -DC model) A1105JC
 D	 F	 Q	 R	 H	

Front Panel Protection Cover (Clear) B9989FA	Probe Case B9918EZ	200 MHz Passive Probe (×4 : DL1640/DL1640L) (×2 : DL1640 700960)	Printer Roll Chart * B9850NX	Rubber Feet (×4) B9989EX
				

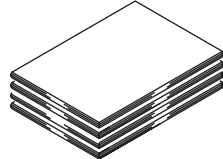
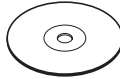
User's Manual Operation Guide I²C-Bus Signal Analysis Function User's Manual** CAN Bus Signal Analysis Function User's Manual***	(×1) (×1) (×1) (×1)	Communication Interface User's Manual CD-ROM B8050XZ
		

* A roll chart will be supplied only when the instrument is equipped with a built-in printer.
 ** Only included with I²C-bus analysis function models.
 *** Only included with CAN bus analysis function models.

Optional Accessories

The following optional accessories are available. On receiving these optional accessories, make sure that all the items that you ordered have been supplied and that they are undamaged. If you have any questions regarding optional accessories, or if you wish to place an order, contact the dealer from whom you purchased the instrument.

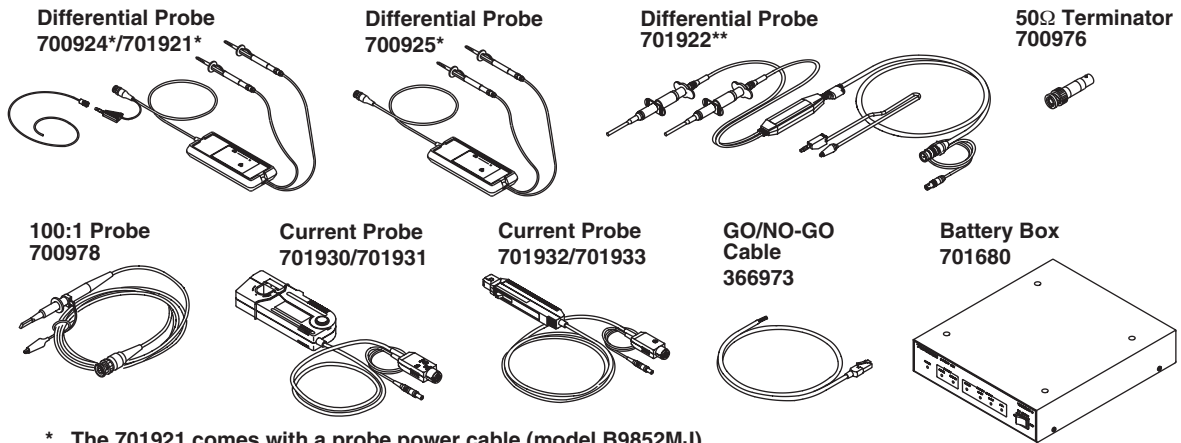

- * The 701921 comes with a probe power cable (model B9852MJ).
The 700924/700925 does not come with a probe power cable (model B9852MJ).
A probe power cable (B9852MJ) is required to supply power from the DL1620/DL1640/DL1640L.
- ** A 50-Ω terminator is required to connect the differential probe (701922) to the DL1620/DL1640/DL1640L.

Optional Spare Parts

The following optional spare parts are available. On receiving these optional spare parts, make sure that all the items that you ordered have been supplied and that they are undamaged.

If you have any questions regarding optional spare parts, or if you wish to place an order, contact the dealer from whom you purchased the instrument.

Part Name	Part No.	Minimum Q'ty	Remarks
Roll chart	B9850NX	5	Thermo-sensible paper, Total
200 MHz passive probe	700960	1	Input impedance: 10 MΩ, Length: 1.5 m
Front panel protection cover (clear)	B9989FA	1	

Safety Precautions

This instrument is an IEC protection class I instrument (provided with terminal for protective grounding).

The following general safety precautions must be observed during all phases of operation, service and repair of this instrument. If this instrument is used in a manner not specified in this manual, the protection provided by this instrument may be impaired. Also, Yokogawa Electric Corporation assumes no liability for the customer's failure to comply with these requirements.

The Following Symbols are Used on this Instrument



To avoid injury, death of personnel or damage to the instrument, the operator must refer to an explanation in the user's manual or service manual.



Function grounding terminal (This terminal should not be used as a "protective grounding terminal.")



Protective grounding terminal



Alternating current



Direct current



Both direct and alternating current



ON (power)



OFF (power)



In - position of a bistable push control



Out - position of a bistable push control

Make sure to comply with the following safety precautions. Not complying might result in injury or death, or damage to the instrument.

WARNING

Power Supply

Before connecting the power cord, make sure that the power supply voltage matches the voltage rating of the instrument and that it does not exceed the maximum rated voltage of the power cord.

Power Cord and Plug

To prevent an electric shock or fire, be sure to use the power cord supplied by YOKOGAWA. The main power plug must be plugged in an outlet with a protective grounding terminal. Do not invalidate protection by using an extension cord without protective grounding.

Protective Grounding

The protective grounding terminal must be connected to ground to prevent an electric shock before turning ON the power.

Necessity of Protective Grounding

Never cut off the internal or external protective grounding wire or disconnect the wiring of the protective grounding terminal. Doing so poses a potential shock hazard.

Defect of Protective Grounding and Fuse

Do not operate the instrument when the protective grounding or fuse might be defective.

Do Not Operate Near Flammable Materials

Do not operate the instrument in the presence of flammable liquids or vapors. Operation of any electrical instrument in such an environment constitutes a safety hazard.

Do Not Remove Any Covers

There are some areas inside the instrument with high voltages. Do not remove any cover if the power supply is connected. The cover should be removed by qualified personnel only.

External Connection

To ground securely, connect the protective grounding before connecting to measurement or control unit. Also, when touching the circuit, turn off the power to the circuit and check that there is no voltage being generated.

To prevent electric shock, connect the ground terminal of the probe or input connector to the protective ground of the object under measurement.

See below for operating environment limitations.

CAUTION

This product is a Class A (for industrial environments) product. Operation of this product in a residential area may cause radio interference in which case the user will be required to correct the interference.

Waste Electrical and Electronic Equipment



Waste Electrical and Electronic Equipment (WEEE), Directive 2002/96/EC
(This directive is only valid in the EU.)

This product complies with the WEEE Directive (2002/96/EC) marking requirement. This marking indicates that you must not discard this electrical/electronic product in domestic household waste.

Product Category

With reference to the equipment types in the WEEE directive Annex 1, this product is classified as a **Monitoring and Control instrumentation** product.

Do not dispose in domestic household waste. When disposing products in the EU, contact your local Yokogawa Europe B. V. office.

Structure of the Manual

Structure of the Manual

This user's manual consists of 16 chapters, an appendix and an index as described below.

Chapter	Title	Content
1	Functions	Introduces the unit's features, functions, and operating principles. Please read this information to familiarize yourself with the unit's capabilities. This chapter does not present operational details.
2	Name and Use of Each Part	Briefly explains the significance and use of the unit's controls, connectors, and screen displays. Includes page references to help you find detailed information quickly.
3	Before Making Measurements	Presents safety precautions, and explains how to install, connect up, and switch on the unit. Also explains how to connect the probes and how to set the date.
4	Common Operations	Explains basic operations, including acquisition start/stop, automatic setup, parameter reset, snapshots, trace clearing, and calibration.
5	Vertical and Horizontal Axes	Explains settings related to vertical (voltage) and horizontal (time) axes. Vertical-axis settings include channel on/off, input coupling, probe attenuation, and voltage sensitivity.
6	Triggering	Explains how to set up and use triggers to control timing of waveform acquisition. Includes description of trigger modes, trigger types, trigger source, and trigger level.
7	Acquisition and Display	Explains acquisition parameters (acquisition mode, sampling mode, record length, history), and use of overlapping (accumulated) waveform display.
8	Display	Explains display format, interpolation, zoom, X-Y display, graticule, and other display-related parameters.
9	Waveform Analysis	Explains cursor-based measurements, automatic measurements, statistical processing, mathematical operations, and GO/NO-GO determinations.
10	Output of Screen Data	Explains how to print screen data to internal printer, or to a printer connected through the USB interface, and how to store screen display to the storage medium.
11	Saving and Loading Data to and from the Storage Medium	Explains how to save and reload waveform data and Storage media settings to floppy disk, PC card, etc. Also explains related disk operations, including disk formatting, file copy, and file deletion.
12	Trigger Input/Trigger Output/RGB Video Signal Output	Explains external-trigger input, external-clock input, trigger output, and RGB video output.
13	Ethernet Interface (Option)	Explains how to save and load to/from a network drive, getting files from a floppy disk, Zip disk, or PC card, how to output to a network printer, and receive e-mail transmissions.
14	Other Operations	Explains how to set the display colors, display language, click sound, and back light.
15	Troubleshooting, Maintenance, and Inspection	Gives troubleshooting advice; explains screen messages and self-test operation.
16	Specifications	Lists the unit's main specifications.
	Appendix	Appendix 1 shows the relationships between the time axis, sampling rate, and record length. Appendix 2 explains waveform area calculation. Appendix 3 gives the format for ASCII file headers. Appendix 4 presents a list of default settings.
	Index	Index of contents.

Conventions Used in this Manual

Units

k Denotes *1000*. Example: 100 kS/s

K Denotes *1024*. Example: 720 KB (storage capacity of a floppy disk)

Bolded Items

Characters written in bold mainly refer to characters or setting values that are displayed on the screen or panel.

Symbols

The following symbols are used in this manual.



Improper handling or use can lead to injury to the user or damage to the instrument. This symbol appears on the instrument to indicate that the user must refer to the user's manual for special instructions. The same symbol appears in the corresponding place in the user's manual to identify those instructions. In the manual, the symbol is used in conjunction with the word "WARNING" or "CAUTION."

WARNING

Calls attention to actions or conditions that could cause serious or fatal injury to the user, and precautions that can be taken to prevent such occurrences.

CAUTION

Calls attentions to actions or conditions that could cause light injury to the user or damage to the instrument or user's data, and precautions that can be taken to prevent such occurrences.

Note

Calls attention to information that is important for proper operation of the instrument.

Terms Used for Descriptions of Operations

The following terms are used in chapters 3 to 15 to distinguish certain features in descriptions.

Relevant Keys

Indicates the relevant panel keys which are necessary to carry out the operation.

Operating Procedure

Carry out steps in the order shown. The operating procedures are given with the assumption that you are not familiar with the operation. Thus, it may not be necessary to carry out all the steps when changing settings.

Explanation

Describes settings and restrictions relating to the operation. A detailed description of the function is not provided. For a detailed description of the function, see Chapter 1.

Functions Described in This Manual and the DL1620/ DL1640/DL1640L Version

The contents of this manual describe the DL1620/DL1640/DL1640L version 1.30 or later. The table below shows the relationship between the DL1620/DL1640/DL1640L versions and the new functions. If the DL1620/DL1640/DL1640L is not of the newest version, you will not be able to use all the functions covered in this manual. Check the DL1620/DL1640/DL1640L version by referring to Soft Version on the overview screen that appears by selecting the MISC key > Overview soft key. For details on the procedure, see section 15.4 in the User's Manual.

For up-to-date information about the DL1620/DL1640/DL1640L versions and the procedure for upgrading your DL1620/DL1640/DL1640L, check the following Web page.

<http://www.yokogawa.com/tm/DL1600/>

DL1620/DL1640/DL1640L Versions and New Functions

Version	Suffix Code	New Functions	Reference Page/ Section/ Chapter
1.10 or later	Standard /F5	<ul style="list-style-type: none"> Chinese menu/message language I²C bus signal analysis function (including the SPI bus signal analysis function) 	Section 14.2 IM701610-61
1.11 or later	Standard	<ul style="list-style-type: none"> DC power supply model + battery box 	Pages 3-6
1.13 or later	Standard /F7	<ul style="list-style-type: none"> WebDAV server function SNTP function Mail attachment function of screen image data CAN bus signal analysis function (including the SPI bus signal analysis function) 	Section 13.13 Section 13.11 Sections 13.6 and 13.7 IM701610-51
1.17 or later	Standard	<ul style="list-style-type: none"> H&V cursor 	Section 9.1
1.20 or later	Standard /B5, /C1, /C10	<ul style="list-style-type: none"> Korean menu/message language Improvement to the data transfer rate of the GP-IB interface YOKOGAWA logo added to the screen image data printed on the built-in, USB, or network printer 	Section 14.2 IM701610-17 Sections 10.2, 10.3, and 13.5
1.30 or later	/C1, /C10	<ul style="list-style-type: none"> Connection of USB storage device to the USB PERIPHERAL interface* 	Section 11.4

* This function is only supported on models that displays "USB(H): Yes(0) USB Mass Storage" on the overview screen.

Contents

Foreword	i
Checking the Contents of the Package	iii
Safety Precautions	vi
Waste Electrical and Electronic Equipment	viii
Structure of the Manual	ix
Functions Described in This Manual and the DL1620/DL1640/DL1640L Version	xi

Chapter 1 Functions

1.1 Block Diagram	1-1
1.2 Setting the Vertical and Horizontal Axes	1-3
1.3 Setting a Trigger	1-8
1.4 Setting the Acquisition and Display Conditions	1-14
1.5 Analyzing the Waveform	1-21
1.6 Communications	1-30
1.7 Other Useful Functions	1-32

Chapter 2 Name and Use of Each Part

2.1 Front Panel/Rear Panel	2-1
2.2 Operation Keys/Jog Shuttle/Knobs	2-3
2.3 Screens	2-6

Chapter 3 Before Making Measurements

3.1 Precautions During Use	3-1
3.2 Installation	3-3
3.3 Connecting the Power Cord	3-5
3.4 Connecting a Probe	3-9
3.5 Compensating the Probe (Phase Correction)	3-12
3.6 Setting the Date and Time	3-14

Chapter 4 Common Operations

4.1 Entering Values and Character Strings	4-1
4.2 Initializing Settings	4-11
4.3 Performing Auto Setup	4-13
4.4 Storing and Recalling Setting Parameters	4-15
4.5 Starting/Stopping Waveform Acquisition	4-17
4.6 The Snapshot and Clear Trace Functions	4-18
4.7 Calibration	4-19
4.8 Using the Help Function	4-21

Chapter 5 Vertical and Horizontal Axes

5.1 Turning Channels ON/OFF	5-1
5.2 Setting the Vertical Position of a Waveform	5-2
5.3 Selecting Input Coupling	5-4
5.4 Selecting Probe Attenuation	5-6
5.5 Setting the Offset Voltage	5-7
5.6 The Preset Function	5-9
5.7 Setting the Bandwidth	5-11
5.8 Setting V/div	5-12

5.9	Displaying Inverted Waveforms	5-14
5.10	Using the Linear Scaling Function	5-15
5.11	Selecting the Timebase	5-17
5.12	Setting T/div	5-19

Chapter 6 Triggering

6.1	Setting the Trigger Mode	6-1
6.2	Setting the Trigger Delay	6-3
6.3	Setting the Trigger Position	6-4
6.4	Setting the Hold Off Time	6-6
6.5	Setting the Edge Trigger (SIMPLE)	6-8
6.6	Setting the External Trigger (SIMPLE)	6-11
6.7	Generating Triggers on the Power Signal (SIMPLE)	6-13
6.8	Setting the AÆB(N) Trigger (ENHANCED)	6-14
6.9	Setting the A Delay B Trigger (ENHANCED)	6-17
6.10	Setting the Pattern Trigger (ENHANCED)	6-20
6.11	Setting the Width (Pulse<T, Pulse>T, T1<PLS<T2, T1<PLS<T2, Time Out) Trigger (ENHANCED)	6-24
6.12	Setting the OR Trigger (ENHANCED)	6-29
6.13	Setting the Window Trigger (ENHANCED)	6-32
6.14	Setting the TV Trigger (ENHANCED)	6-35
6.15	Setting the Action-On Trigger	6-39

Chapter 7 Acquisition and Display

7.1	Setting the Record Length	7-1
7.2	Acquisition Mode	7-2
7.3	Using the Sequential Store Function	7-5
7.4	Using the High-resolution Mode	7-6
7.5	Setting Repetitive Sampling Mode ON/OFF	7-7
7.6	Using the History Memory	7-8
7.7	Searching the Historical Data Using Zone (History Search Function)	7-11
7.8	Searching the Historical Data Using Parameters (History Search Function)	7-15

Chapter 8 Display

8.1	Changing the Display Format	8-1
8.2	Setting the Interpolation Method	8-3
8.3	Changing the Graticule	8-5
8.4	Turning Display of the Scaling Value ON/OFF	8-6
8.5	Setting the Waveform Labels	8-7
8.6	Accumulated Waveform Display	8-9
8.7	Turning the Translucent Mode ON/OFF	8-11
8.8	X-Y Waveform Display	8-12
8.9	Zooming the Waveform	8-14
8.10	Search Data Using Search and Zoom Function	8-17

Chapter 9 Waveform Analysis

9.1	Measuring Waveforms Using Cursors	9-1
9.2	Automated Measurement of Waveform Parameters	9-14
9.3	Statistical Processing	9-21
9.4	Performing Automated Measurements of Waveform Parameters on Dual Areas	9-28
9.5	Adding, Subtracting, and Multiplying Waveforms	9-35



9.6	Displaying the Power Spectrum	9-38
9.7	Smoothing	9-42
9.8	Phase-Shifted Display	9-44
9.9	GO/NO-GO Determination Using the Measurement of Waveform Parameters	9-45
9.10	GO/NO-GO Determination Using Zones	9-49
9.11	Using the GO/NO-GO Signal Output Function	9-54

Chapter 10 Output of Screen Image Data

10.1	Loading the Paper Roll into the Built-in Printer (Option)	10-1
10.2	Outputting Screen Image Data to the Built-in Printer (Option)	10-3
10.3	Outputting Screen Image Data to a USB Printer (Option)	10-6
10.4	Storing Screen Image Data to the External Storage Medium	10-10

Chapter 11 Saving and Loading Data to and from the Storage Medium

11.1	Floppy Disks	11-1
11.2	Zip Disks	11-2
11.3	PC Card	11-4
11.4	Connecting USB Storage to the USB PERIPHERAL Interface	11-5
11.5	Formatting the Storage Medium	11-7
11.6	Saving/Loading Waveform Data	11-11
11.7	Saving/Loading Setup Data	11-18
11.8	Saving/Loading Snapshot Waveforms	11-23
11.9	Saving the Results of the Automated Measurement of Waveform Parameters	11-27
11.10	Saving the Cursor Measurement Values	11-30
11.11	Changing the File Attributes, Deleting Files	11-33
11.12	Copying Files	11-37
11.13	Changing the Directory/File Name of the Storage Medium and Creating a Directory .	11-41

Chapter 12 Trigger Input/Trigger Output/RGB Video Signal Output

12.1	External Trigger Input, External Clock Input	12-1
12.2	Trigger Output (TRIG OUT)	12-3
12.3	RGB Video Signal Output (RGB VIDEO OUT)	12-5
12.4	Using the CH1 OUT Signal	12-7

Chapter 13 Ethernet Interface (Option)

13.1	Connecting the DL1620/DL1640/DL1640L to a Personal Computer/Workstation through an Ethernet Interface (Option)	13-1
13.2	Configuring the Ethernet Interface (TCP/IP)	13-3
13.3	Saving and Loading Waveform and Setting Data to and from a Network Drive (FTP Client Function)	13-8
13.4	Saving Screen Image Data to a Network Drive (FTP Client Function)	13-11
13.5	Sending Screen Image Data to a Network Printer (LPR Client Function)	13-14
13.6	Using the Mail Function (Fixed Interval)	13-16
13.7	Using the Mail Function (Action Mail Function)	13-19
13.8	Accessing DL1620/DL1640/DL1640L Drives from a Network Drive (FTP Server Function)	13-21
13.9	Viewing the Ethernet Interface Option and MAC Address	13-23
13.10	Setting the FTP Passive Mode and LPR/SMTP Timeout	13-24
13.11	Setting the Time Difference from the GMT (Greenwich Mean Time) and SNTP	13-26
13.12	Using the Web Server Function	13-28
13.13	Using the Instrument as a Windows Network Drive (Version 1.13 or Later)	13-52

Chapter 14 Other Operations

14.1 Setting the Screen Color and Brightness 14-1

14.2 Changing the Menu/Message Language and Click Sound 14-4

14.3 Turning OFF the Backlight and Setting the Brightness of the Backlight 14-6

14.4 Canceling the Offset Voltage 14-8

14.5 Changing the USB Keyboard Language/Confirming the Type of Keyboard that is
Connected(Optional) 14-9

Chapter 15 Troubleshooting, Maintenance and Inspection

15.1 Troubleshooting 15-1

15.2 Messages and Corrective Actions 15-2

15.3 Self-Diagnostic Test (Self Test) 15-8

15.4 Checking the System Condition 15-11

15.5 Resetting the Circuit Breaker (DC Power Supply Model) 15-12

15.6 Recommended Replacement Parts 15-13

Chapter 16 Specifications

16.1 Input Section 16-1

16.2 Trigger Section 16-2

16.3 Time Axis 16-4

16.4 Display 16-4

16.5 Functions 16-4

16.6 Built-in Printer (Option) 16-6

16.7 Storage 16-7

16.8 USB PERIPHERAL Interfaces (Option) 16-7

16.9 Auxiliary Input/Output Section 16-8

16.10 Computer Interface 16-9

16.11 General 16-10

16.12 External Dimensions 16-12

Appendix

Appendix 1 Relationship between the Time Axis Setting, Sample Rate and
Record Length App-1

Appendix 2 How to Calculate the Area of a Waveform App-13

Appendix 3 ASCII Header File Format App-15

Appendix 4 List of Defaults App-19

Appendix 5 Assignment of Keys on the USB Keyboard App-20

Index



1.1 Block Diagram

System Configuration

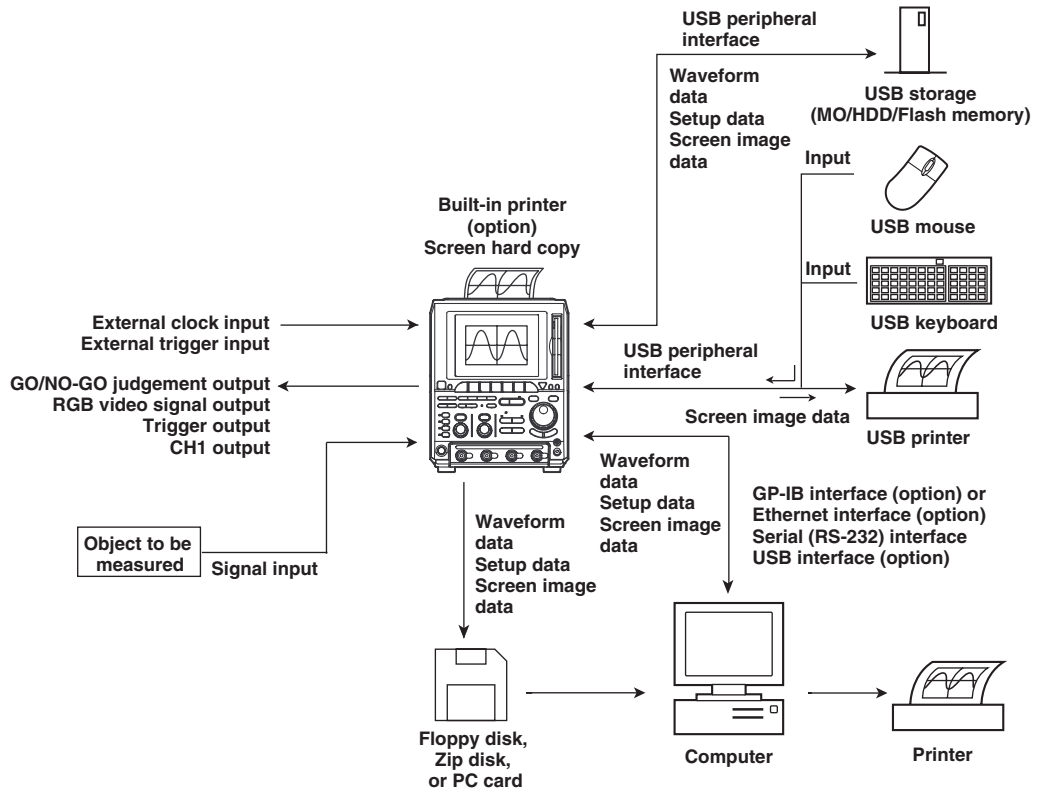

Block Diagram

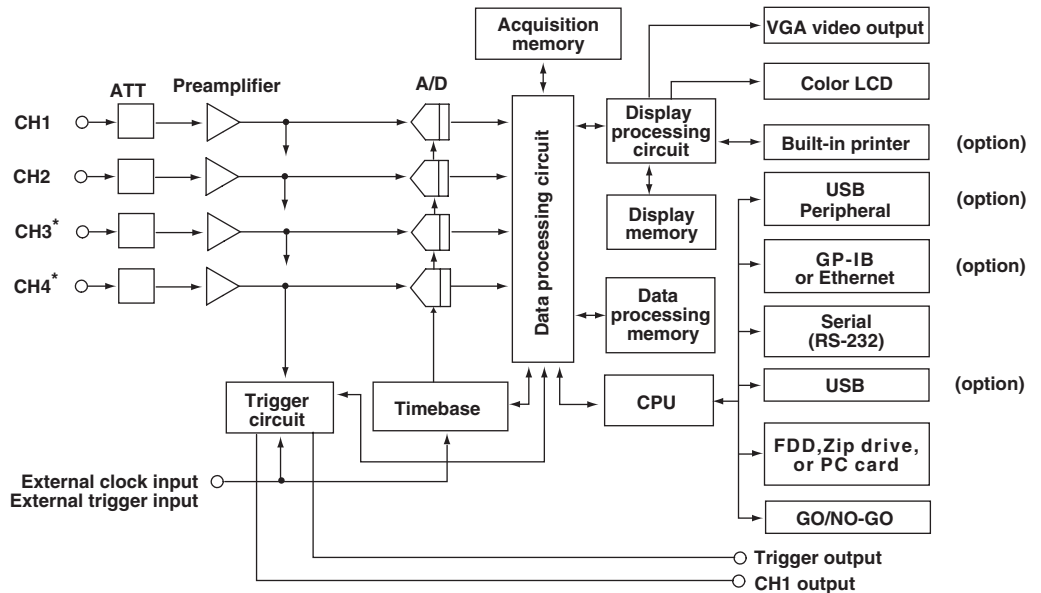

* The DL1620 is not equipped with channels 3 and 4. Instead, an external trigger/external clock multi-purpose terminal is installed in place of the CH4 terminal.

1.1 Block Diagram

Signal Flow

The signals to be measured enter at the input terminals and pass first to the attenuator (ATT) and preamplifier. Adjusted vertical-axis characteristics (voltage and amplitude) in accordance with the settings for input coupling, probe attenuation, V/div, and offset value are passed to the A/D converter.

Voltages are converted to digital values by the A/D converter. The digital data is then processed by the data processing circuit (digital file processing, etc.). Further, averaging and other types of processing are performed after cropping at the appropriate sampling rate (as determined by the time axis settings), and the resulting data is written to the acquisition memory.

The data written in the acquisition memory is then converted to waveform display data by the processing circuit and transferred to the waveform processing circuit by which the data are stored in the display memory. Waveforms are displayed on the screen based on the data stored in the display memory.

1.2 Setting the Vertical and Horizontal Axes

Time Axis <Sections 5.11 and 5.12>

Selection of the Timebase

With the default settings, sampling timing is controlled by the clock signal output from the timebase circuit of the instrument (see the Block Diagram, section 1.1). The sampling timing can be controlled by an external clock signal instead of the clock signal from the timebase circuit.

An external clock signal can be input to the EXT CLOCK IN terminal on the rear panel. This external clock function is useful when you are observing a signal whose period varies or when you are observing a waveform by synchronizing it with the clock signal to be measured.

Setting the Time Axis

When using the internal clock, set the time axis scale as a time duration per division of the grid. The setting range is 2 ns/div to 800 s/div. The time range in which waveform is displayed is "time axis setting x 10," as the display range along the horizontal axis is 10 divisions.

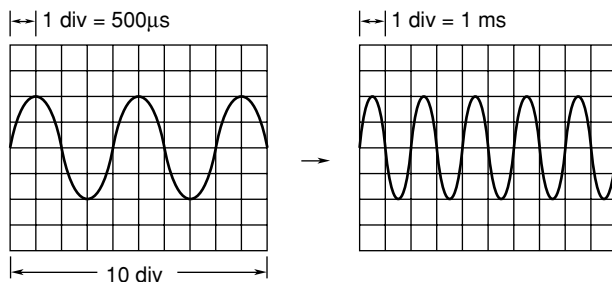

Note

Display of Time Axis Direction

The sampled data is read into the acquisition memory, and a waveform is displayed based on this data. The number of data stored into the acquisition memory differs depending on settings such as time axis settings, trigger mode, and acquisition mode.

The number of display lines in the time axis direction on a 10 - div screen is 500 lines. Processing therefore varies according to record length, as described immediately below. (for more details on the relation between time axis, acquisition mode, record length of acquisition memory and displayed record length, see Appendix 1).

- If displayed record length exceeds number of screen display points, multiple data points are connected with a line and displayed at the same time axis position.
- If displayed record length is less than number of screen display points, the oscilloscope interpolates the data to generate the display. (See page section 1.4)

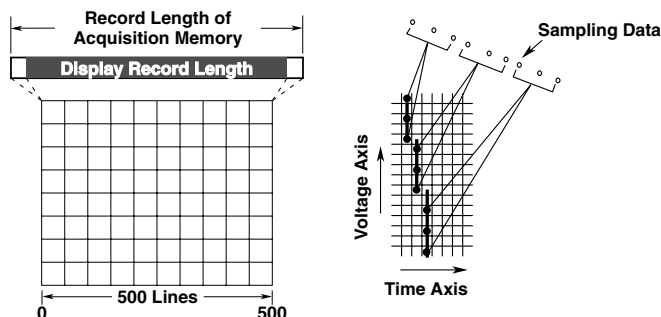

1.2 Setting the Vertical and Horizontal Axes

Relationship between the Time Axis Setting, Sample Rate and Record Length

Changing the time axis causes corresponding changes in the sampling rate and the acquisition record length. For more detailed information, see Appendix 1.

Relationship between Time Axis Setting and Sampling Mode

The sampling method (sampling mode) for an input signal changes according to the time axis setting as described hereafter. But note that the time axis range over which this feature is actually available will vary according to the maximum displayable record length, as shown in Appendix 1.

- **Real-Time Sampling Mode**

Changing the time axis causes a corresponding change in the sampling rate. The maximum sampling rate is 200 MS/s (or 100 MS/s if the high-resolution mode is ON.). The input signal is sampled sequentially, and data is stored in the acquisition memory. In this mode, the waveform can only be displayed correctly at frequencies up to half the sample rate, due to Nyquist's theorem*. Sample rate is expressed in S/s (number of samples per second). Thus, this mode is suitable for observation of a waveform which fluctuates more slowly than the sample rate.

* If the sample rate is higher than the frequency of the input signal, high-frequency components will be lost. In this case, a phenomenon in which high-frequency components change to lower frequency components occurs, due to Nyquist's theorem. This phenomenon is called aliasing. Aliasing can be avoided by setting the acquisition mode to envelope mode and acquiring the waveform.

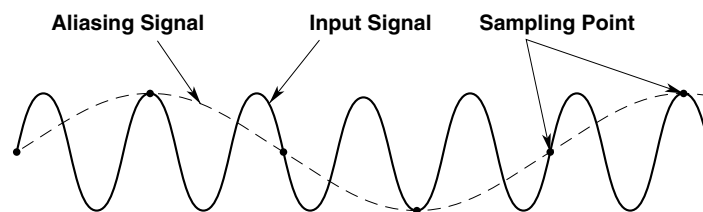

- **Repetitive Sampling Mode**

To enable this mode, you must set the time axis so that the sampling rate is greater than 200 MS/s (high-resolution mode ON: 100 MS/s). Under this mode, the oscilloscope produces a single waveform by taking samples over several periods of a repetitive signal, so that the sampling rate appears higher than it actually is. An apparent sample rate of up to 50 GS/s can be used.

Furthermore, even in the real-time sampling mode, if the sample rate exceeds 200 MS/s (high-resolution mode ON: 100 MS/s) due to the time axis and the displayed record length settings, the sampling mode automatically changes to repetitive sampling.

There are two repetitive sampling methods: sequential sampling, in which a signal is sampled sequentially at a fixed interval, and random sampling, in which a signal is sampled at random to produce a waveform. This instrument uses a random sampling method which also enables observation of the waveform up to the trigger point.

Time Axis Setting and Roll Mode Display

If the time axis is set within a certain range (see Appendix 1), then the display will not be updated by trigger anymore (update mode), but the mode will switch to roll mode when new data is acquired. In roll mode, the oldest data is deleted, and the waveform shifts from right to left on the screen. A waveform can be observed in the same way as it is recorded on a pen recorder. This mode is useful when you are observing a signal which repeats or which fluctuates slowly. This mode is also useful when you want to detect glitches (fast spikes on a waveform) which occur intermittently.

* Rolling display also operates during single - start acquisition, although trigger occurrence causes the waveform to stop.

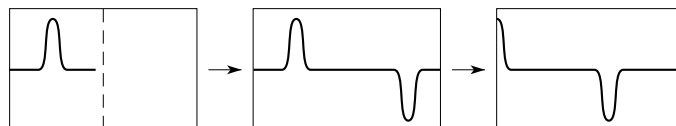

Vertical Sensitivity <Section 5.8>

The V/div (vertical sensitivity) setting is used to adjust the amplitude of the displayed waveform so that the waveform can be observed easily.

The V/div setting is made by setting the voltage value per division on the screen grid. The vertical sensitivity setting operates by switching to a different attenuator (attenuation rate). The setting changes in steps (1 V/div → 2 V/div → 5 V/div ...).

In addition, by performing computations on the digital data acquired using the voltage sensitivity above, the waveform can be displayed at a sensitivity of 0.4 (or 0.5) to 10 times the voltage sensitivity that was used to acquire the data (Variable).

When V/div is Switched from 1 V/div to 0.50 V/div

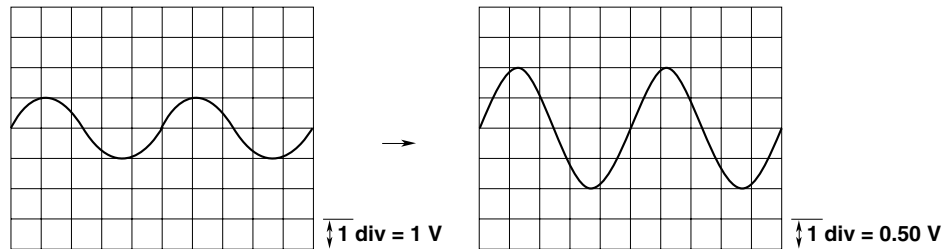
**Note****Vertical Sensitivity and Measurement Resolution**

To get precise readings, it is recommended that you set the vertical sensitivity so that the waveform's maximum and minimum amplitudes are close to the top and bottom of the screen. Note that the instrument uses 8-bit A/D converters. Incoming signals are sampled at a resolution of 255 levels (LSB), or 32 levels per division.

Effective Data Range

The instrument uses 8-bit A/D converters. Assuming that output values range from 0 to 255, the vertical center line of the display corresponds to a value of 127. Because the A/D converter reaches full range at 255, screen level 256 is not used.

Note also that the instrument treats an A/D output value of 0 as if it were a 1.

The screen's effective display range extends approximately 5.29 divisions in each direction from the screen's center line.

However, if the vertical axis position is moved while the data acquisition is stopped, the effective data range also moves by the same amount.

Vertical Position <Section 5.2>

Since a total of four input waveforms can be displayed, they may overlap each other making observation difficult. In this case, the waveforms can be moved in the vertical direction so that they can be observed more easily.

The vertical position mark can be set to any value in the range between ± 4 div.

Changing the V/div setting, the vertical axis setting is rescaled with respect to the vertical position.

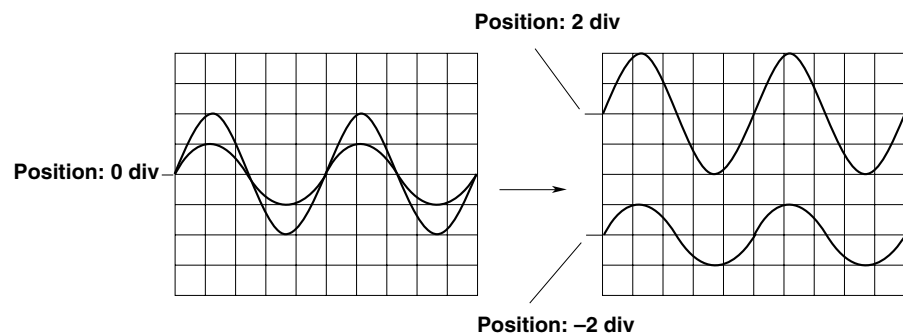

Offset Voltage <Section 5.5>

When observing a voltage riding on top of a predetermined voltage, an offset voltage can be applied to eliminate the predetermined voltage so that only the changes in the signal can be observed with higher voltage sensitivity.

Normally, the offset voltage does not affect the cursor measurement values, automated measurement of waveform parameters, and computed values. However, you can turn ON offset cancel to apply the offset voltage to them. (See section 14.4.)

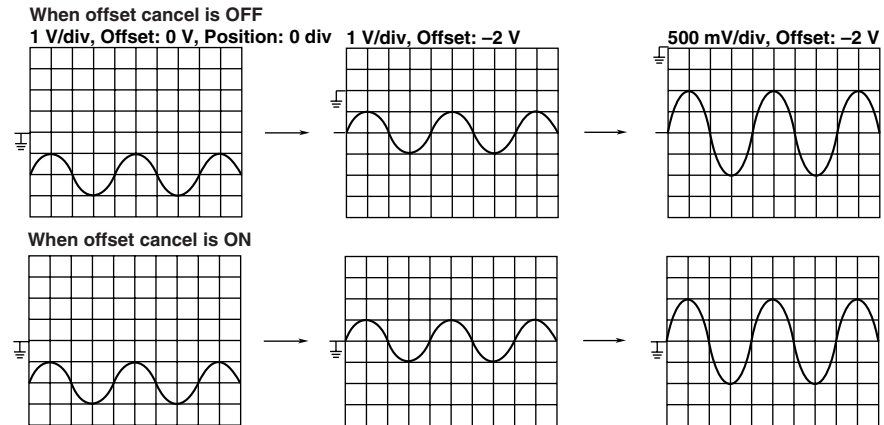

Input Coupling <Section 5.3>

When you only want to observe the amplitude of an alternating current signal, eliminating the direct current components from the input signal makes observation easier. You may also want to check the ground level or observe the input signal waveform with the offset voltage removed. In these cases, you can change the input coupling setting. This will switch the coupling method, which determines how the input signal is input to the vertical control circuit (voltage axis).

The input coupling method can be chosen from the following:

AC

The input signal is sent through a capacitor to the attenuator in the vertical control circuit. This method can be used when you just want to observe the amplitude of the alternating current signal, eliminating the DC components from the input signal.

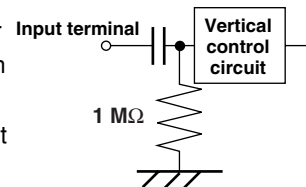

DC

The input signal is sent directly to the attenuator in the vertical control circuit.

This method can be used when you want to observe both the DC and AC components of the vertical input signal.

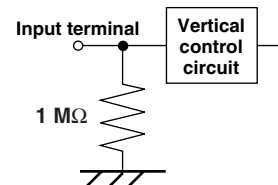

GND

The ground signal, not the input signal, is connected to the attenuator in the vertical control circuit. This method enables observation of the ground level on the screen.

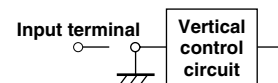

Probe Attenuation <Section 5.4>

A probe is usually used to connect the circuit to be measured to an input terminal. Use of a probe provides the following advantages.

- The voltage and current of the circuit to be measured are not disturbed.
- A signal can be input without distortion.
- The measurement voltage range of the oscilloscope can be widened.

A 200 MHz passive probe is supplied with the instrument. The probe enables you to select whether the input signal is attenuated to 1/10 or 1/1*. When a probe is used, the probe attenuation must match the instrument's attenuation setting so that the input voltage can be measured directly.

When using the 200 MHz Passive Probe (voltage probe) that comes with the instrument, enter a setting of 10:1 or 1:1.

The voltage probe settings that are available on the instrument are 1:1, 10:1, 100:1, and 1000:1, and for the current probe, 10 A:1 V (0.1 V/A), and 100 A:1 V (0.01 V/A). When using a probe other than one supplied with the instrument, set the attenuation ratio on the instrument to match that of the probe used.

* For the differences in the specifications depending on the attenuation ratio, see page 3-10.

Bandwidth Limit <Section 5.7>

The bandwidth limit can be set for each channel. The DL1620/DL1640/DL1640L combines the common analog filters with FIR and IIR filters, allowing you to select the 20 MHz, 1.28 MHz, 640 kHz, 320 kHz, 160 kHz, 80 kHz, 40 kHz, 20 kHz, and 10 kHz bandwidth limits.

- Full: Bandwidth is not limited.
- 20 MHz: Analog and FIR filters are used to limit bandwidth.
- 10 kHz to 1.28 MHz: Analog, FIR, and IIR filters are used to limit bandwidth.

Analog Filter

When using the analog filter independently, the cutoff frequency (3-dB attenuation) is approximately 24.2 MHz, but when combined with the FIR filter, it becomes approximately 20 MHz.

FIR (Finite Impulse Response) Filter

The FIR filter is a secondary filter that uses data sampled at 200 MHz to filter a weighted moving average. The calculation is done according to the following equation:

$$Y_n = (X_{n-2} + 2 \times X_{n-1} + X_n) / 4$$

where:

Y_n is the n^{th} filtered data

X_n is the n^{th} data before filtering

X_{n-1} is the $(n-1)^{\text{th}}$ data before filtering

X_{n-2} is the $(n-2)^{\text{th}}$ data before filtering

The cutoff frequency becomes approximately 20 MHz when combined with the analog filter.

IIR (Infinite Impulse Response) Filter

The IIR filter is a secondary filter that filters data sampled at 100 MHz. Depending on the settings, the following cutoff frequencies are available:

1.28 MHz, 640 kHz, 320 kHz, 160 kHz, 80 kHz, 40 kHz, 20 kHz, 10 kHz

The attenuation characteristic is 40 dB/decade.

1.3 Setting a Trigger

Trigger Type <Chapter 6>

There are two principal trigger types which you can use with the instrument.

Simple trigger

Enhanced trigger

Simple Trigger → Sections 6.5 to 6.7

This is an edge trigger and the one which is used normally.

Enhanced Trigger → Sections 6.8 to 6.14

This is a complex trigger. The following seven types of enhanced trigger are available.

A→B(N) trigger

A Delay B trigger

Pattern trigger

Width trigger

OR Trigger

Window trigger

TV trigger

Edge Trigger → Section 6.5

The edge trigger is the simplest type of trigger and uses a single trigger source to activate a trigger. A trigger is activated when the trigger source exceeds (rises above) or drops (falls) below the preset trigger level*.

In addition to input signals (CH1 to CH4, or CH1 and CH2 for the DL1620), the external trigger input signal, the commercial power supply signal that is used by the instrument can be used as a trigger source.

* "A trigger is activated" refers to the condition in which trigger conditions are satisfied and a waveform is displayed.

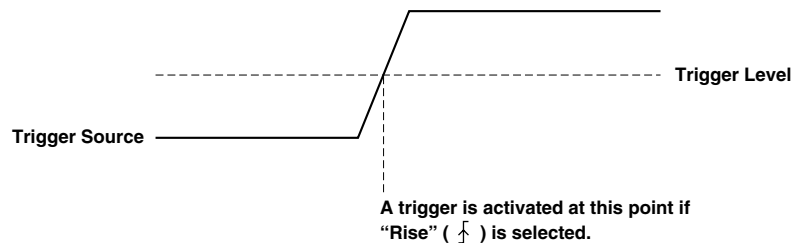

A → B(N) Trigger (Enhanced Trigger) → Section 6.8

This function activates a trigger the Nth time condition B becomes true after condition A has become true.

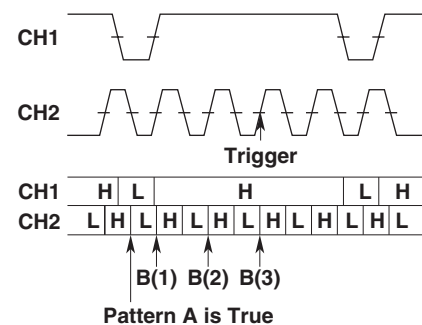

When pattern A: CH1 = L, CH2 = L, Enter, When patternB: CH1 = H, CH2 = H, Enter, N = 3
L: Low level, H: High level

A Delay B Trigger (Enhanced Trigger) → Section 6.9

This function activates a trigger the first time condition B becomes true after condition A becomes true and the specified time elapses.

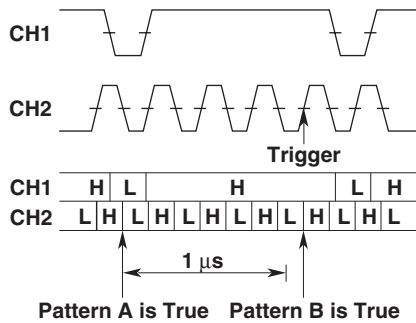

When pattern A: CH1 = L, CH2 = L, Enter, When pattern B: CH1 = H, CH2 = H, Enter, Delay = 1 µs

Pattern Trigger (Enhanced Trigger) → Section 6.10

Multiple trigger sources are selected, and a trigger is activated when all of the trigger conditions set for each trigger source become true or false. Trigger conditions are established by setting combinations of the state (High or Low) of each trigger source. Furthermore, one of the trigger sources can be used as the clock signal, and triggering is synchronized with this clock signal.

Example: a trigger is activated when CH1: L, CH2: L, CH3*: H and CH4*: L (* The DL1620 is not equipped with channels 3 and 4.)

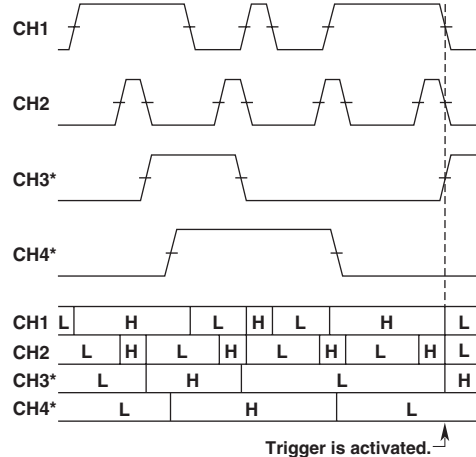

Pulse Width Trigger → Section 6.11

The time period during which the specified condition is met or not met is compared with the specified time period. The trigger condition is set with the AND of the signal state of each channel (High, Low, or Don't Care) or the AND of the window conditions of each channel (IN, OUT, or Don't Care).

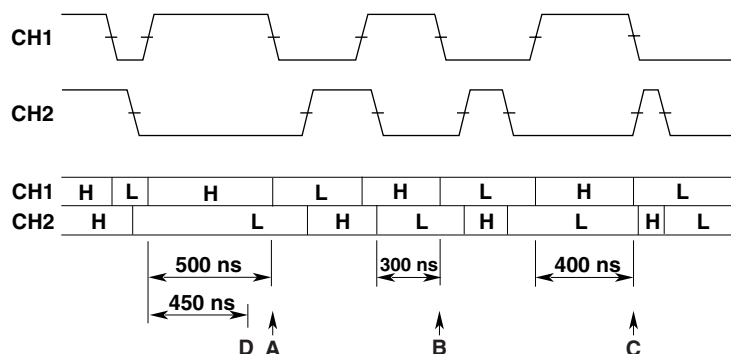

1.3 Setting a Trigger

The description of the figure above is as follows.

If CH1 = H, CH2 = L, CH3 = X, CH4 = X, Condition = True, Time = 350 ns: (The DL1620 is not equipped with channels 3 and 4.)

The trigger is activated at point B if Pulse < T.

The trigger is activated at points A and C if Pulse > T.

The trigger is activated at point C if $T1 < PLS < T2$ where $Time1 = 350$ ns, $Time2 = 450$ ns.

The trigger is activated at points A, B, and D if $T1 < PLS < T2$ where $Time1 = 350$ ns, $Time2 = 450$ ns.

The trigger is activated at point D if "Time out" is specified where Time = 450 ns.

OR Trigger (Enhanced Trigger) → Section 6.12

A trigger is activated when any of the edge trigger conditions specified on CH1 to CH4 (or CH1 and CH2 for the DL1620) or the window condition is met. A trigger is activated by either the rising edge of CH1 or CH2.

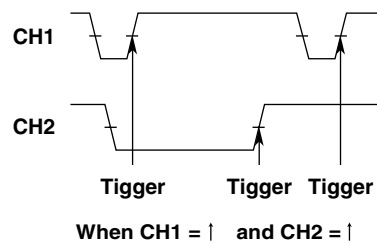

Window Trigger (Enhanced Trigger) → Section 6.13

A certain voltage range (window) is set and a trigger is activated when the trigger source level enters this voltage range (IN) or exits from this voltage range (OUT).

It is possible to combine the use of the Window trigger with the OR or Pulse Width trigger.

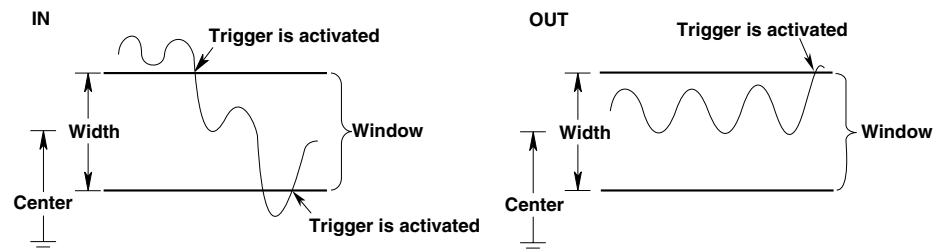

TV Trigger (Enhanced Trigger) → Section 6.14

The TV trigger is used when you are observing a video signal, and is compatible with broadcasting systems such as NTSC, PAL, etc.

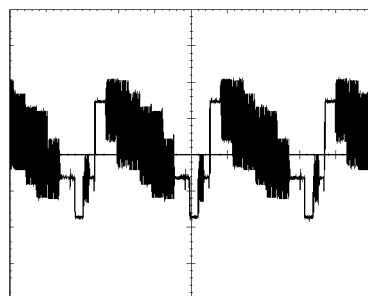

Trigger Mode <Section 6.1>

Conditions for updating displayed waveforms are set. The following five types of trigger mode are available:

Auto Mode

Displayed waveforms are updated each time a trigger is activated within a specified time (approximately 100 ms, referred to as the time-out period) and are updated automatically after each time-out period.

Auto Level Mode

Waveforms are displayed in the same way as in Auto mode if a trigger is activated within the time-out period. If no trigger is activated, the center value of the amplitude of the trigger source (section 1.3) is detected and the trigger level is changed automatically to this center value, then a (edge) trigger is activated to update the displayed waveforms.

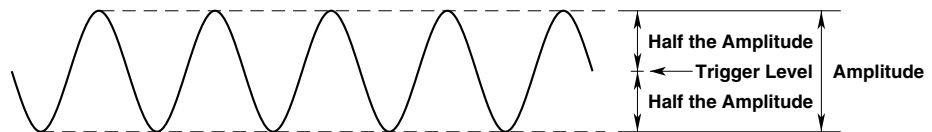
**Normal Mode**

Displayed waveforms are updated only when a trigger is activated. Displayed waveforms will not be updated if no trigger is activated.

Single Mode

When a trigger is activated, displayed waveforms are updated only once, then acquisition stops. This mode is useful when you are observing a single-shot signal.

Single (N) Mode

This mode is useful when using the sequential store function (see section 7.3). Waveforms are acquired and stored in different memory areas each time a trigger is activated, then acquisition stops, and the waveforms are displayed. Acquisition is performed the specified number of times. Acquired waveforms can be displayed together, or they can be displayed individually. This mode is useful when you want to detect a sudden abnormality in a waveform.

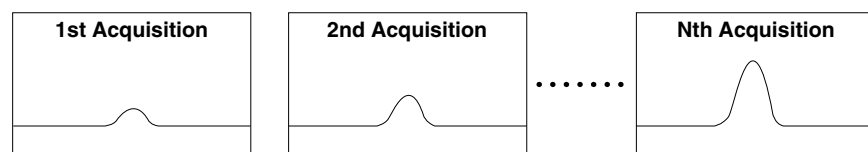
**Action-On Trigger <Section 6.15>**

The displayed waveform can be output to the optional built-in printer, buzzer, or saved to a floppy disk, a Zip disk, or a PC card each time a trigger is activated. Also sends a mail (Ethernet interface (option)).

Trigger Coupling <Sections 6.5, and 6.8 to 6.13>

Input coupling can also be switched for trigger sources as it is for input signals. Select the type of input coupling which is most suitable for the trigger source signal.

The following two types of input coupling are available for trigger source signals.

- DC: The trigger source signal is used as the trigger source without any process.
- AC: The trigger source signal is used as the trigger source after DC the content has been removed from it. A trigger can always be activated if the trigger level is set to 0 V as long as the signal's amplitude is one division or more.

HF Rejection <Sections 6.5, and 6.8 to 6.13>

Set HF rejection to ON when you want to remove high frequencies exceeding 15 kHz from the trigger source. This prevents a trigger from being activated unexpectedly due to high-frequency noise.

Trigger Hysteresis <Sections 6.5, and 6.8 to 6.13>

If the trigger level width is not sufficient, the trigger point fluctuates each time a trigger is activated if noise is present in the trigger source, thereby resulting in unstable displayed waveforms. To solve this problem, a specified margin (hysteresis) can be added to the selected trigger level.

The hysteresis level can be chosen from “ $\overline{\Delta}$ ” and “ Δ .” If “ $\overline{\Delta}$ ” is selected, a wide hysteresis level is provided to eliminate fluctuation in the trigger point, thereby resulting in a stable displayed waveform. However, in this case, the trigger points become uncertain. Thus, select “ Δ ” if you want to activate a trigger to detect small fluctuations in a waveform.

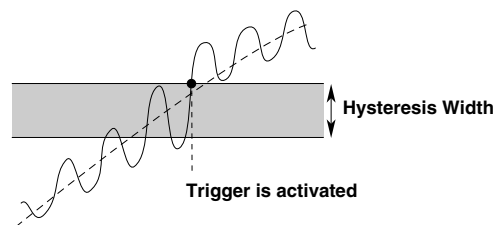

Trigger Source and Trigger Level <Sections 6.5 to 6.13>

Trigger Source: Selects the signal for the selected trigger type. The external trigger signal or the commercial power supply signal can also be used a trigger source.

Trigger Level: Sets the voltage level used to judge trigger conditions such as trigger slope (rise/fall of a signal).

Trigger Hold-Off <Section 6.4>

The trigger hold-off function temporarily stops detection of the next trigger once a trigger has been activated. For example, when observing a pulse train signal, such as a PCM code, display of the waveform can be synchronized with repetitive cycles; or when using the history memory function, you may want to change the repetitive period, as shown below.

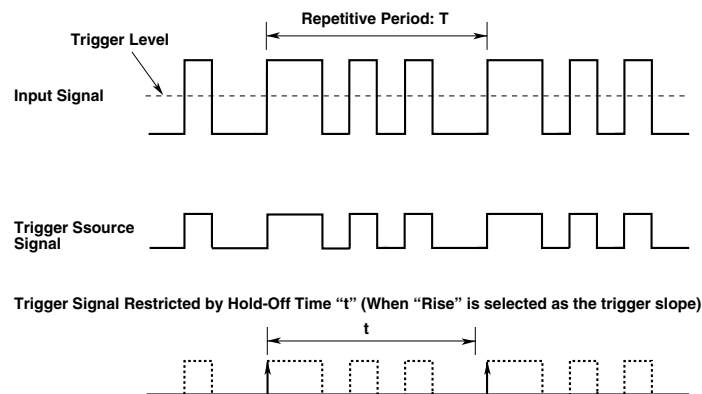

Trigger Delay <Section 6.2>

Normally, the waveform around the trigger point is displayed. However the trigger delay function enables display of a waveform which has been acquired after a specified time (called the delay time) has elapsed following activation of a trigger. The range for the trigger delay setting is 0 to 4 seconds.

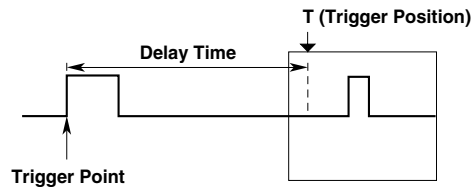
**Trigger Position <Section 6.3>**

The trigger position indicates which position of the waveform in the acquisition memory will actually be displayed on the screen. The trigger point refers to the point at which a trigger is activated. In case the trigger delay (to be explained here after) is set to 0s, the trigger point and the trigger position see the same location.

You use this setting to select how much pre-trigger area and how much post-trigger area to show on the display.

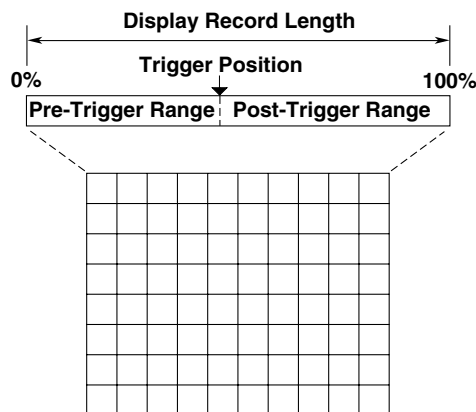

1.4 Setting the Acquisition and Display Conditions

Record Length <Section 7.1>

The term “record length” refers to the number of data points (per channel) acquired in the acquisition memory. “Displayed record length” refers to the number of these data points that are actually displayed on the screen. (Note that sampling rate and record length will vary according to the time axis setting; see section 1.2.) It is possible to set the following record lengths. (The maximum record length that can be set varies depending on the status of the high-resolution mode.)

DL1620/ : 1 kword, 10 kwords, 100 kwords, 1 Mword, 8 Mwords (in high-resolution mode 4 Mwords).

DL1640L : 1 kword, 10 kwords, 100 kwords, 1 Mword, 4 Mwords, 10 Mwords, 32 Mwords (in high-resolution mode 16 Mwords).

The displayed record length is identical to the (acquisition) record length. For details, see Appendix 1.

High-resolution mode <Section 7.4>

Ordinarily, data converted to digital values by the 8-bit A/D converter is processed according to the settings and saved by the device as 8-bit data in the acquisition memory.

For filtering that uses the FIR filter or IIR filter digital calculation methods, data is processed at 8 bits or higher to minimize calculation errors. Further, limiting the bandwidth improves the S/N ratio and enables data exceeding 8 bits in length. Using the DL164/DL1640L, the S/N ratio can be improved to allow data of up to about 13 bits.

When the high-resolution mode is ON, calculated data is saved in acquisition memory as 16-bit data. Therefore, data obtained through filtering that exceeds 8 bits can also be saved. However, when the bandwidth limitation is set to Full, the resolution does not improve even if the high-resolution mode is ON because there is no filtering.

When the high-resolution mode is ON, the following restrictions apply. These restrictions do not apply when high-resolution mode is OFF.

- The maximum sampling rate of the real-time sampling mode is halved (100 MS/s)
- The maximum recording length is halved (DL1620/DL1640: 4 Mwords/CH; DL1640L: 16 Mwords/CH)
- The number of triggers that can be held in history memory is halved

When the high-resolution mode is OFF, all data is saved as 8-bit data, regardless of bandwidth limit settings.

Acquisition Modes <Section 7.2, 7.4>

When storing sampled data in the acquisition memory, it is possible to perform processing on specified data and display the resultant waveform. The following data processing methods are available.

Normal Mode

In this mode, sampled data are stored in the acquisition memory without processing.

Averaging Mode

Averaging is a process in which waveforms are acquired repeatedly to obtain the average of waveform data of the same timing (the same time in relation to the trigger point).

If this mode is active, the instrument takes the linear or exponential average of incoming data and writes the results into acquisition memory. You can set an average count of Infinite for exponential averaging, or in the range from 2 to 65536 (in 2^n steps where n is a natural number) for simple averaging. Set the attenuation constant for exponential averaging in the range from 2 to 256 (2^n steps where n is a natural number).

Exponential Averaging (Count = Infinite)

$$A_n = \frac{1}{N} \{(N - 1) A_{n-1} + X_n\}$$

A_n: Value Obtained After nth Averaging

X_n: nth Measured Value

N : Attenuation Constant
(2 to 256, in steps of 2^n)

Linear Averaging (Count = 2 to 65536)

$$A_N = \frac{\sum_{n=1}^N X_n}{N}$$

X_n: nth Measured Value

N : Number of Averaging Times
(Acquisition Count,
in steps of 2^n)

This averaging process is useful when you want to eliminate random noise.

Envelope Mode

In normal mode and averaging mode, the sample rate (the number of times data is acquired per second in the acquisition memory) drops if T/div is increased (see Appendix 1 "Relationship between the time axis setting, sample rate and record length").

However, in the envelope mode, the maximum and minimum values are determined at every time interval from the data sampled at 200 MS/s (high-resolution mode: 100 MS/s). The time interval used to determine the values is the twice sampling interval of the normal mode. The maximum and minimum values are paired and acquired in the acquisition memory.

Envelope mode is useful when you want to avoid aliasing (section 1.2), since the sample rate is kept high irrespective of the time axis setting (T/div). Furthermore, envelope mode is also useful when you want to detect glitches (pulsing signals which rise very fast) or display an envelope of a modulating signal.

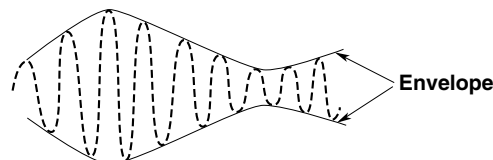

Sequential Store <Section 7.3>

In the real-time sampling mode, waveform data will be stored in the acquisition memory only a set number of times, and all waveforms can be displayed. This stops automatically after acquisition. The maximum acquisition count available with the feature varies depending on the record length.

The range for the DL1620/DL1640 is 2 to 4000 times (for the DL1640L, it is 2 to 16000 times).

Once the specified number of waveforms have been stored, you can display any of the waveforms individually or all of them together, so that it is possible to derive a time series of the waveform variation. The drawings below illustrate how stored data can be displayed (assuming sequential storage of 100 waveforms).

Display Example in Case Count = 100 Times

Displaying All Waveforms
(ALL)

Displaying Newest Waveform
(Selected Record No. = 0)

Displaying Oldest Waveform
(Selected Record No. = -99)

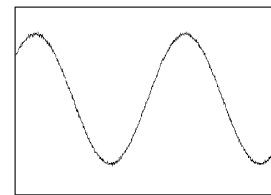
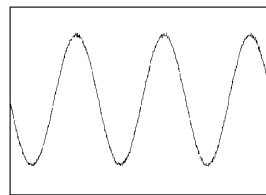
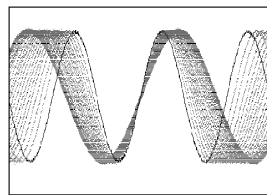

Sampling Mode <Section 7.5>

As explained earlier in "Relationship between the time axis setting and sampling mode" (section 1.2), data sampling can be performed either in real-time or in repetitive sampling mode depending on the time axis and record length. The available time axis range under repetitive mode varies according to the acquisition settings. For details, see Appendix 1.

Accumulated Waveform Display <Section 8.6>

This mode holds each waveform on the screen for a time that is longer than the update cycle, so that multiple waveforms are overlapped. The waveform age can be identified by color.

The following two modes are available.

- **Persist:** Overlaps the display of waveforms using the display color of each channel. The intensity is gradually reduced, and the waveform disappears after the specified time.
- **Color:** Overlaps the display of waveforms using 8 colors which signify the frequency of occurrence of the data values.

This function is useful when you want to observe jitters and temporary turbulence in waveforms.

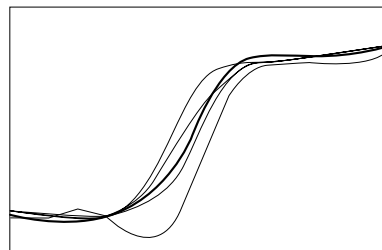

History Memory <Section 7.6>

The oscilloscope automatically retains the last N waveforms recorded. The value of N varies in the range 2 to 4000 for the DL1620/DL1640 (2 to 16000 for the DL1640L) depending on the record length and high-resolution mode. The oscilloscope retains all waveforms for the first N triggers; then, for each subsequent trigger, the oscilloscope overwrites the oldest stored waveform. You are free to switch the display from the current (newest) waveform to any of other N-1 waveforms in the history. The illustration below shows how data can be displayed, assuming N = 1024.

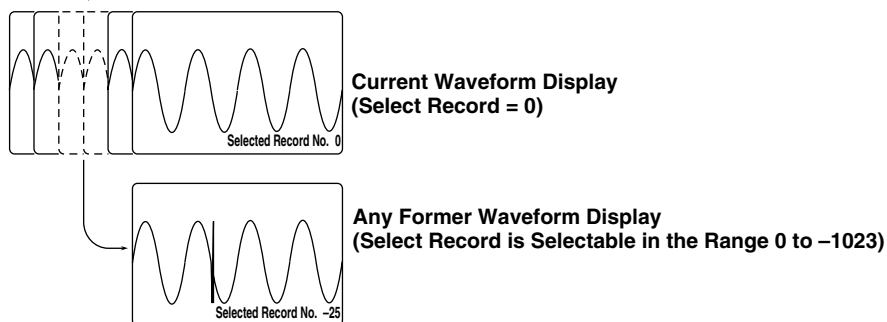
Saved Waveform Data of Previous 1024 Triggers

In addition, a particular waveform can be found from the past waveforms that are held.

Display Settings <Chapter 8>**Display Format → Section 8.1**

- You can display waveforms from different channels in different windows. You can choose to use 1 window (Single), 2 windows (Dual), or 4 windows (Quad). (4 windows (Quad) is not available on the DL1620.)
- You can select either of the following two methods for assigning channels to windows.
 - Auto: Channels that are set to ON are displayed in order of channel number, with the lowest channel displayed in the top window.
 - Fixed: Channels are displayed in order of channel number, regardless of whether ON or OFF.
 - User: Arbitrarily assign the channels to the split screens, regardless of whether the channel display is turned ON.

Graticule → Section 8.3

Use this feature to select use of grid, frame, or “cross” graticule.

Scale Values → Section 8.4

If the Scale Value setting is ON, the screen displays numerical values at the top and bottom of the vertical axis and the horizontal axis.

1.4 Setting the Acquisition and Display Conditions

Waveform Labels → Section 8.5

You can assign an arbitrary label (up to 8 characters) to each waveform.

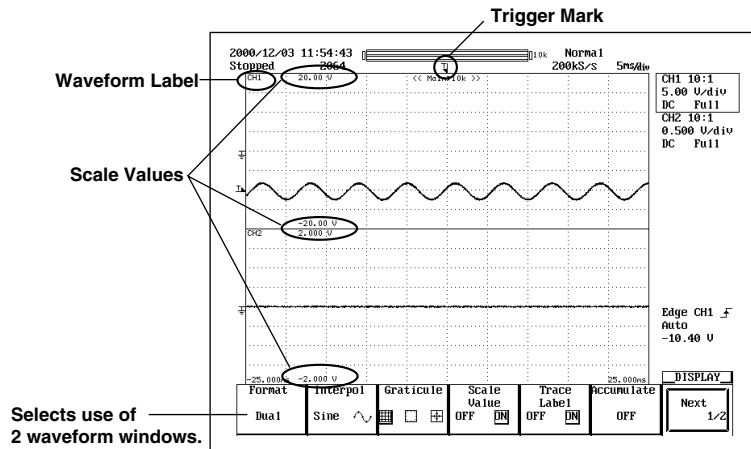

Display Interpolation <Section 8.2>

This feature selects the type of interpolation applied in areas where there are less than 500 sample points (Less than 250 points in the zoom window when zooming on the waveform using Main & Z1 & Z2) per 10 time axis divisions. (These areas are referred to as interpolation areas.) Three settings are available.

Line Interpolation

Interpolates between two dots using a straight line.

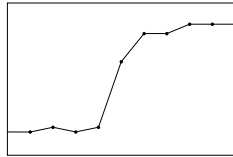

Sine Interpolation

Generates interpolation data using the function $\frac{\sin x}{x}$ then interpolates between two dots using resulting sine curve. Sine interpolation is suitable for observation of sine waves.

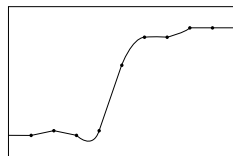

Pulse Interpolation

Interpolates between two dots using a step.

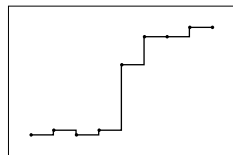

No Interpolation

Displays measurements as discrete dots, without interpolation.

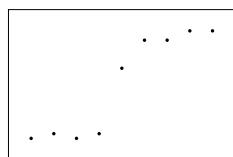

X-Y Waveform Display <Section 8.8>

This feature plots the voltage values of one input waveform (on the X axis) against the voltage values of the others (on the Y axis, which have their display turned ON). The X-Y plot lets you view the relationship between the signal voltages. The X-Y waveforms and normal waveforms (a waveform displayed using voltage and time axes) can be displayed simultaneously.

Use of this X-Y waveform display function enables measurement of the phase angle between two sine wave signals. For example, two X-Y sine waveforms are displayed to obtain an X-Y waveform (called a Lissajous waveform), from which the phase angle can be obtained.

Lissajous Waveform

Phase Angle 0°			
Phase Angle 45°			
Phase Angle 90°			
Frequency Ratio (X : Y)	1 : 1	1 : 2	1 : 3

Expanded Waveform <Section 8.9>

Waveforms can be expanded in the time axis direction. This function is useful when you want to change the T/div setting after the waveform has been displayed in single mode or when you want to extend the acquisition time to observe a particular part of the waveform thoroughly.

Zooming is not available on areas with less than 11 data points.

You set the zoom position according to its time axis location.

Zoom Display Arrangement

You can display one or two zoom windows on the screen. Four display arrangements are available, as follows.

Main: Main area

Z1, Z2: Zoom area

<Main>		<Main>		<Z1>	<Z1>
<Z1>	<Z2>	<Z1> or <Z2>		<Z2>	or <Z2>

1.4 Setting the Acquisition and Display Conditions

If you display the “main” area (normal waveform display) together with one or both zoom windows, the main area will include vertical lines (or “zoom boxes”) indicating the zoom area (s). The center of the zoom area corresponds to the center of the zoom box.

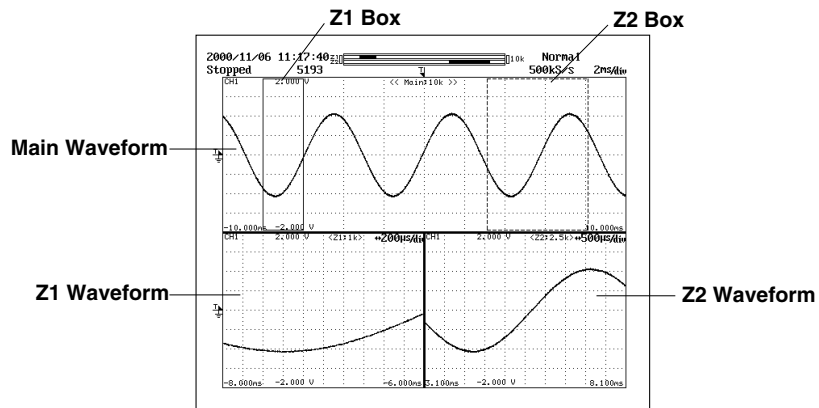

1.5 Analyzing the Waveform

Linear Scaling <Section 5.10>

It is possible to append a scaling constant A, an offset value B and a unit to the measurement value X of cursor or automated measurements. Linear scaling is useful, when applying a voltage divider ratio to the measurement values. Linear scaling is also handy when you want your scope to automatically convert the measured voltage results into the (for example, current or temperature) measurement unit of your signal source.

$$Y(\text{UNIT}) = AX + B \quad Y = \text{result of linear scaling}$$

Cursor Measurements <Section 9.1>

You can use the following cursor types to analyze the waveform data.

- **V Cursors (Vertical)**

Two vertical broken lines (V cursors) are displayed. The time from the trigger position to each V cursor and the time difference between the V cursors are measured. In addition, the voltage of the signal at each cursor position and the voltage difference between the cursors are measured.

- **H Cursors (Horizontal)**

Two horizontal broken lines (H cursors) are displayed. The values in the vertical direction of each H cursor and the difference between the two are measured.

- **Marker Cursors (Markers)**

Use this feature to place one or two markers onto the waveform. You can then read the voltage value and time value (relative to trigger position) at each marker, and the voltage difference and time span between the markers.

- **Angle Cursors (Degree)**

Set the measurement zero point and the end point and then using the angle corresponding to the width between the two as a reference, measure the angle of the two angle cursors.

- **H & V Cursors (H&V)**

H cursors and V cursors are displayed simultaneously.

- **Statistical Processing of Historical Data (Vertical History)**

Performs the V cursor measurements of the waveform acquired using the history memory function and, calculates the maximum and minimum values, mean value, and standard deviation.

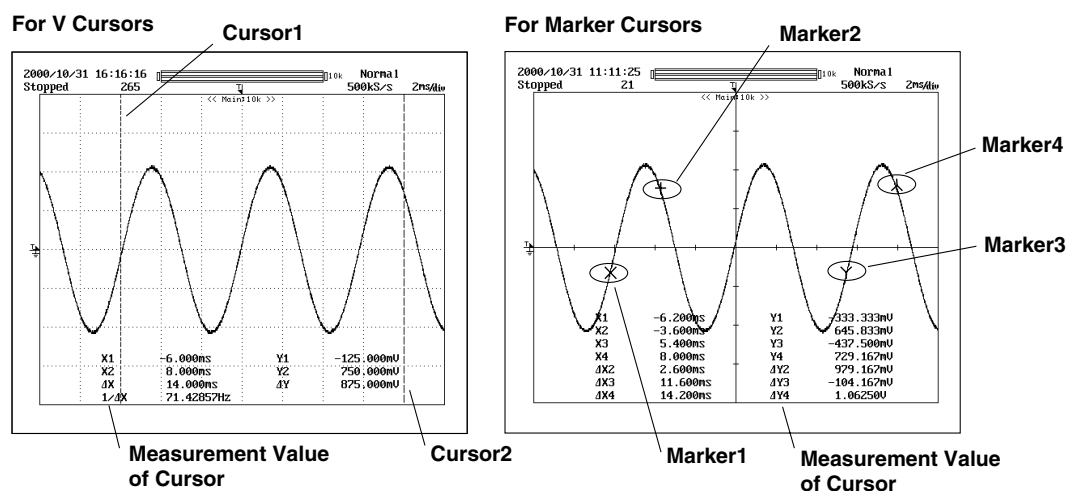

Automated Measurements <Section 9.2 to 9.4>

Automatic Measurement of Waveform Parameters → Section 9.2

This feature automatically measures selected waveform parameters, such as rise time and pulse width. You can select parameters separately for each channel, although you are limited to a total of 12 parameters to display. There are 27 parameters available for selection.

The measurements are made for data in the acquisition memory.

Statistical Processing → Section 9.3

Statistical processing is performed on the automated measured values described above. The following five statistics are determined on the two measured values of automated measurement parameters.

- Maximum value (Max)
- Minimum value (Min)
- Average value (Avg)
- Standard deviation (Sdv)
- Number of measured values used in the statistical processing (Cnt)

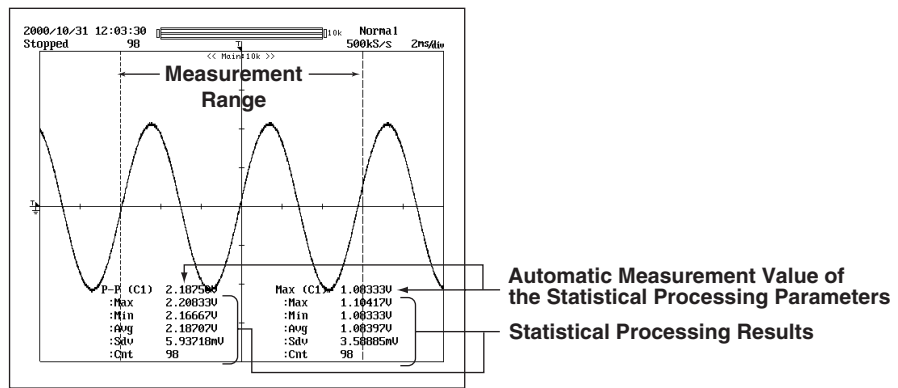

The following three methods are available in the statistical processing.

- **Normal Statistical Processing**

While acquiring waveforms, statistical processing is performed on all the waveforms acquired up to that point.

- **Statistical Processing for Each Period**

Divides the displayed waveform using a period that is automatically calculated and performs statistical processing on the measured values over the determined period. Statistical processing is performed from the oldest measured data of the displayed waveform.

Example in which CH1 is selected as the target waveform for determining the period

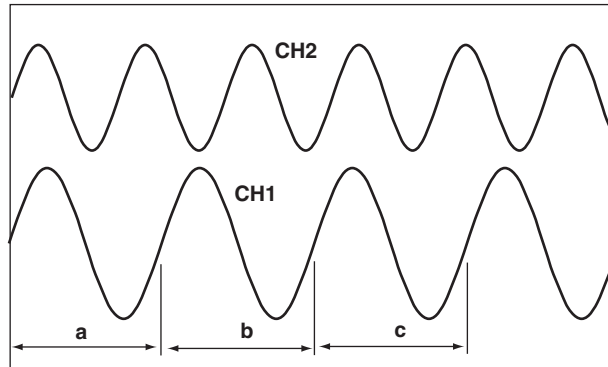

The parameters for automated measurement are measured in each range a, b, and c, and statistical processing is performed on each automated measurement parameter in the order a, b, and c.

Automated measurement parameters of other channels are also measured over each range a, b, and c.

Automated measurement can also be performed on the period of each waveform.

- **Statistical Processing of Historical Data**

Performs automated measurement of waveform parameters on the waveform that is acquired using the history memory function and performs statistical processing. Statistical processing is performed from the oldest waveform.

Perform Automated Measurements of Waveform Parameters on Dual Areas → Section 9.4

You can specify two areas and perform automated measurement of waveform parameters on each area. You can also perform computation on the parameters determined in the two areas. Statistical processing for each period is not possible.

Waveform Math <Chapter 9>

Addition, Subtraction, and Multiplication → Section 9.5

Addition, subtraction, and multiplication can be performed between CH1 and CH2 with Math1, and CH2 and CH3 for Math2 (or CH1 and CH2 with Math1 for the DL1620). The result is displayed as waveform Math1 or Math2 (or waveform Math1 on the DL1620). Addition and subtraction are useful for comparing signals to the standard signal, checking the signal logic, and comparing signal phases. Multiplication is useful for checking power signals by applying voltage and current signals.

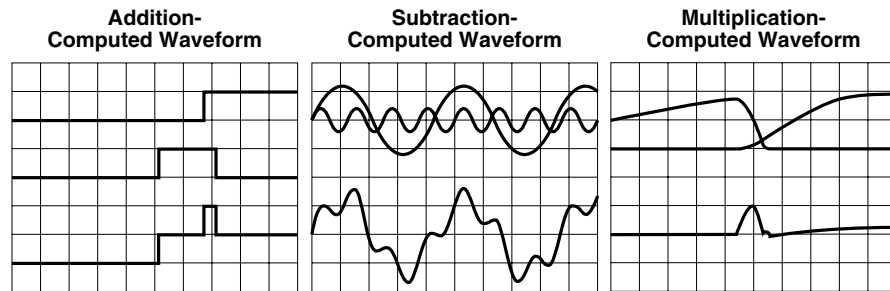

Scaling of Math1 and Math2 Waveforms → Section 9.5 to 9.6

The instrument normally auto scales when displaying the computed waveform, but manual scaling can also be selected.

If you select auto scaling, the center value and sensitivity suitable for displaying the waveform is calculated from the voltage axis, offset voltage, type of computation, and other factors of the waveform being computed.

If you select manual scaling, then the center value and sensitivity of the computed waveform display can be set to any desired values.

Phase-Shifted Addition, Subtraction, and Multiplication → Section 9.8

Displays the phase-shifted waveforms of CH1 to CH4 or performs a computation using the phase-shifted waveforms (or CH1 and CH2 for the DL1620).

Power Spectrum Display <Section 9.6>

FFT (Fast Fourier Transform) computation can be performed on the input signal to display its power spectrum. This is useful when you want to check the frequency distribution of the input signal.

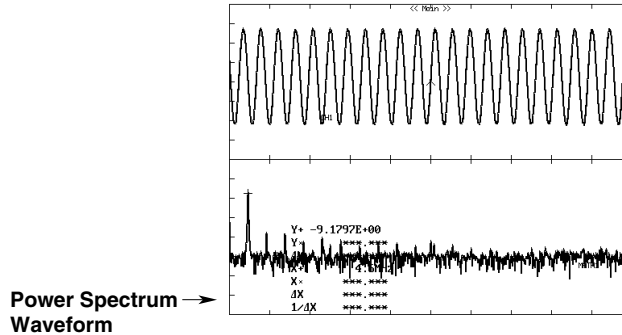

Three time windows are available: a Rectangular window, a Hanning window, and a Flattop window.

The Rectangular window is effective for transient signals, such as impulse waves, which attenuate completely within the time window. The Hanning window allows continuity of the signal by gradually attenuating the parts of the signal located near the ends of the time window down to the “0” level. Hence, it is effective for continuous signals. The frequency resolution of the Hanning window is higher than that of the Flattop window. However, the level accuracy of the spectrum of the Flattop window is higher than that of the Hanning window. When the waveform being analyzed is a continuous-type signal, select the appropriate window that suits the application.

FFT computation generates 1000 or 10000 measurement data points, but only half points are displayed on the screen.

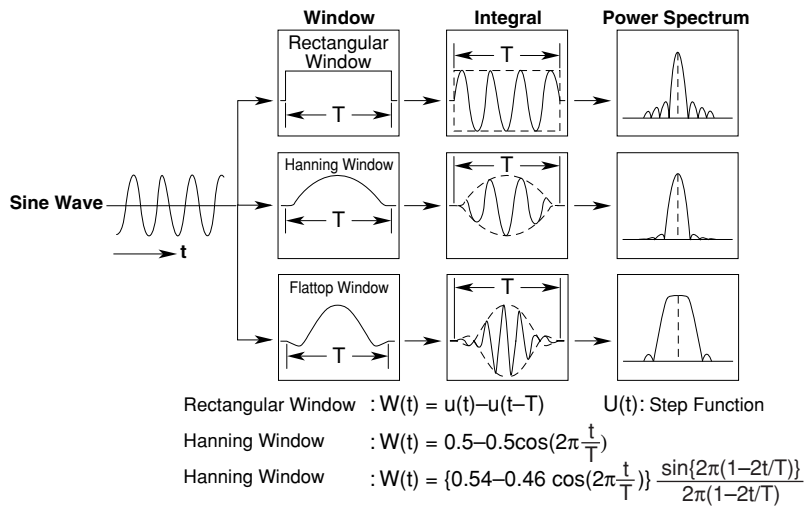

FFT Function

When the complex result of FFT computation is $G = R + jI$, the power spectrum can be expressed as follows.

DC component: $10 \log(R^2 + I^2)$ AC component: $10 \log \left(\frac{R^2 + I^2}{2} \right)$

R: Real Part I: Imaginary Part

Reference (0dB) for Log Magnitude: $1V_{rms}^2$

Data Search (History Search Function) <Sections 7.7 to 7.8>

This feature can be used to search waveforms that match the specified conditions from the history memory.

History Memory Search Using Zone → Section 7.7

Searches waveforms that did or did not pass through the specified area from the history memory.

Waveform that was Saved Using the History Memory Function

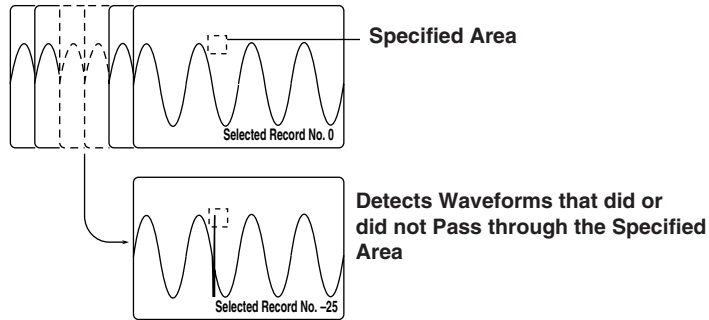

History Memory Search Using Waveform Parameters → Section 7.8

Searches waveforms that did or did not satisfy the specified condition from the history memory.

Waveform that was saved using the history memory function

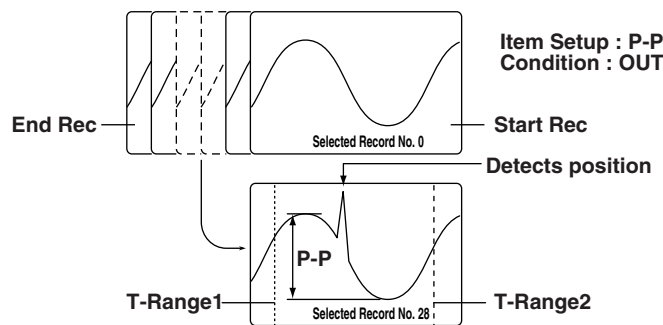

Data Search (Search and Zoom Function) <Section 8.10>

Edge Search

Searches the position where the signal went above (rising) or below (falling) the specified level the specified number of times from the search start position. Displays the waveform expanded around the detected position in the zoom window.

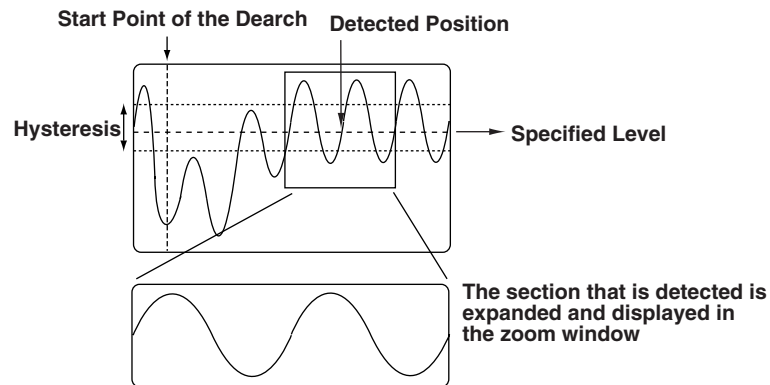

When the edge is set to rising and the count is set to 2

Serial Pattern Search

Searches for a section of the waveform that has the same pattern as the specified waveform pattern (specified using High or Low status or Don't Care). The status of the waveform (64 statuses) is detected at the rising or falling edge of the channel that is specified as the clock channel or at a constant time interval. The matched pattern is displayed expanded in the zoom window.

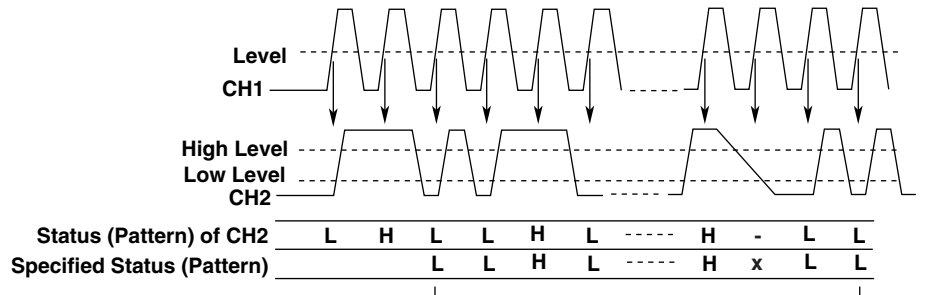

Conditions:
 Clock Channel : CH1
 Timing to Check the Status : Rising
 Channel on which to Perform the Search : CH2

Searches Sections of the Waveform with the Same Status (up to 64 Patterns) as the Specified Waveform Pattern

The Section that is Detected is Expanded and Displayed in the Zoom Window

Parallel Pattern Search

Detects a section of the waveform where the status (specified as High, Low, or Don't Care) of each channel, CH1 through CH4, Math1, and Math2 (or CH1, CH2 and Math1 for the DL1620), is the same as the specified status. The status is detected at the rising or falling edge of the channel that is specified as the clock channel. If the clock channel is set to None, detection is performed on the status of all waveforms, CH1 through CH4, Math1, and Math2 (or CH1, CH2 and Math1 for the DL1620). The detected section is displayed expanded in the zoom window.

- Search Example in which the Clock Channel is Set to None and H1: L, CH2: L, CH3*: H, and CH4*: L

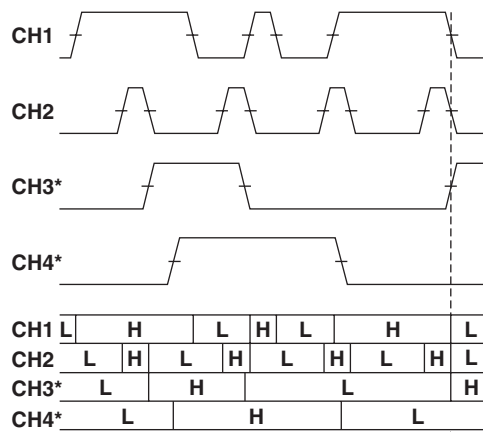

L: Low Level, H: High Level

Detects this Position and Displays the Waveform Expanded in the Zoom Window

* The DL1620 is not equipped with channels 3 and 4.

1.5 Analyzing the Waveform

- Example in which the clock channel is set to CH1 and CH1: rising, CH2: L, CH3*: H, and CH4*: L

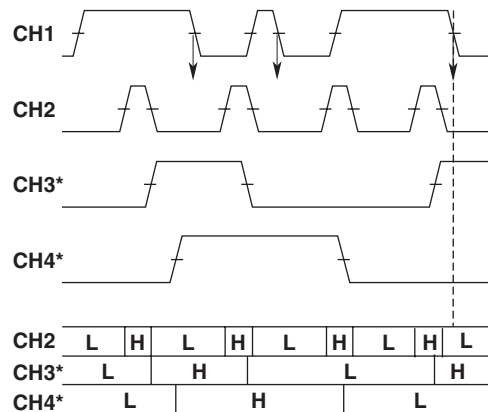

L: Low Level, H: High Level

Detects this Position and Displays the Waveform Expanded in the Zoom Window

* The DL1620 is not equipped with channels 3 and 4.

Pulse Width Search

From the search start position, search for a portion of the waveform containing a pulse which is longer or shorter than a previously defined length of time. Expand the retrieved portion of the waveform per the zooming factor and display it in the waveform zoom display window.

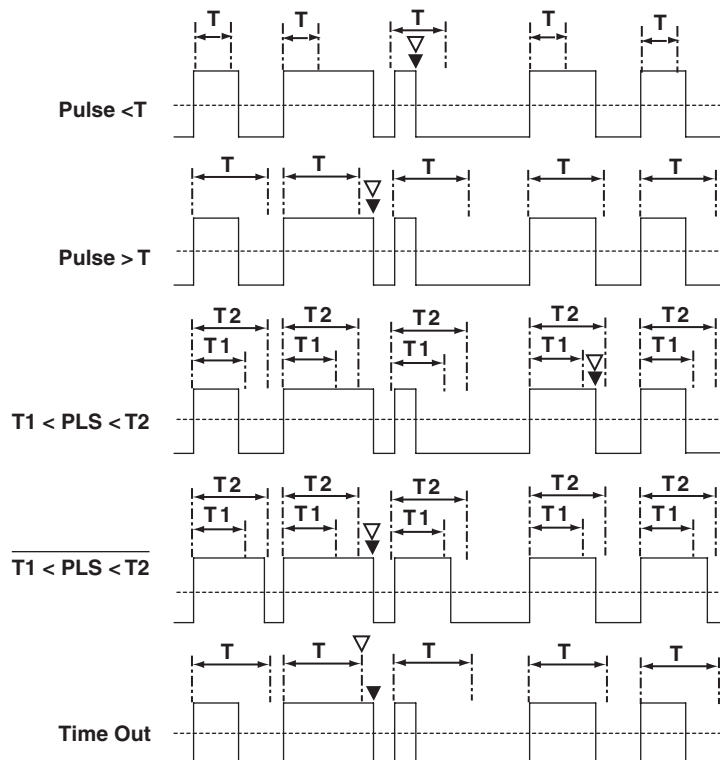

▽ Zoom Screen Center Position

▼ Starting Point for Next Search

Pulse : The Length of Time a Specified Condition is Fulfilled

T : A Specified Length of Time

Auto Scroll

The zoom box scrolls automatically in a designated direction. You can stop the zoom box while checking zoomed waveforms.

1.6 Communications

Ethernet Interface (Option)

<Chapter 13 and Communication Interface User's Manual (IM701610-17E)>

Saving and Loading to and from a Network Drive (FTP Client Function)

→ Sections 13.3, 13.4

You can save, delete, and copy waveform data, screen image data, and setting information onto the hard drives of devices on the network such as a PC or workstation running the FTP server function just as you would onto internal floppy disks, Zip disks, or PC cards.

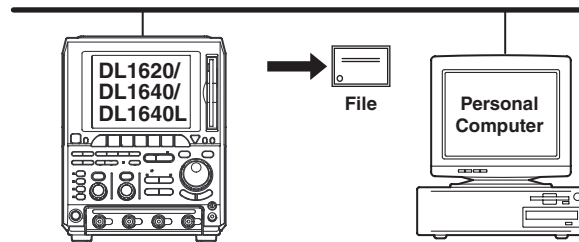

File Retrieval from the DL1620/DL1640/DL1640L Floppy Disk, Zip Disk, or PC Card (FTP Server Function) → Section 13.8

You can download files from the internal floppy disk, Zip disk, or PC card of the DL1620/DL1640/DL1640L using a networked PC or workstation acting as the client.

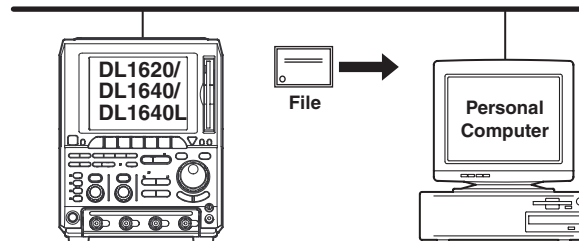

Outputting to a Network Printer (LPR Client Function) → Section 13.5

You can print screen images to a network printer just as you would to the DL1620/DL1640/DL1640L's built-in printer or to a printer with a USB interface.

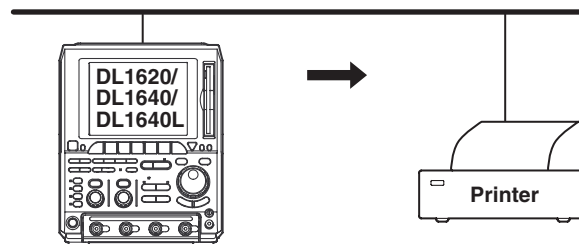

Mail Transmission (SMTP Client Function) → Sections 13.6, 13.7

You can send transmissions to a given e-mail address at specified intervals. Using this function, you can periodically transmit such information as GO/NO-GO results and the measurement rate.

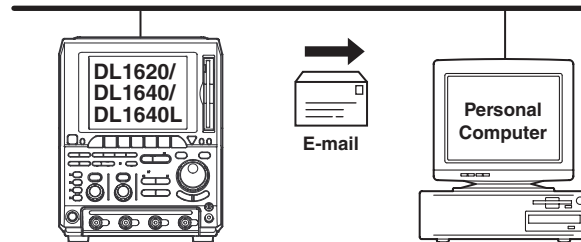
**Web Server Function → Section 13.12**

You can use the DL1620/DL1640/DL1640L as a Web server. From the DL1620/DL1640/DL1640L Web page you can transfer files, monitor waveform display, perform basic DL1620/DL1640/DL1640L key operations, and acquire waveform data.

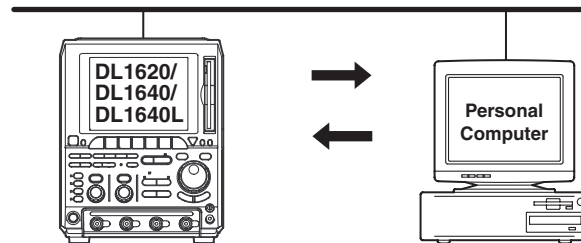
**Network Interface → Communication Interface User's Manual (IM701610-17E)**

You can output waveform data to a PC for analysis using the Ethernet interface, or perform waveform measurement by controlling the instrument with an external controller.

Serial, GP-IB (Option), and USB (Option) Interfaces**<The Communication Interface User's Manual (IM701610-17E)>**

A serial (RS-232C) interface comes standard with the DL1620/DL1640/DL1640L. GP-IB and USB interfaces are also available as options. Through communication functions, you can output waveform data to a PC for data analysis or control the DL1620/DL1640/DL1640L using an external controller to carry out waveform measurements.

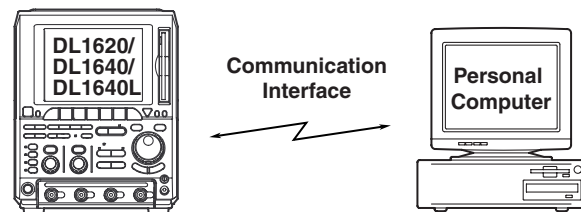

1.7 Other Useful Functions

Connecting a USB Keyboard (Option) <Section 4.1>

You can connect a USB keyboard for entering file names, comments, and other information. In addition, the keys on the keyboard are assigned to the keys on the front panel of the DL1620/DL1640/DL1640L, which allows you to operate the DL1620/DL1640/DL1640L in a similar fashion. (See Appendix 5.)

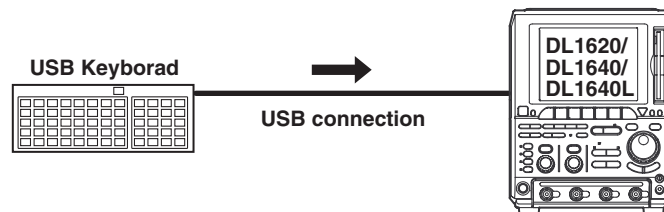

Connecting a USB Mouse (Option) <Section 4.1>

You can connect a USB mouse to use the menu screen of the DL1620/DL1640/DL1640L.

Initialization <Section 4.2>

This function resets the key settings to the factory settings (default settings), and is useful when complex settings have been made and you want to cancel all of them at once.

However, settings related to communications and setting parameters on storing and recalling function are not reset.

Auto Setup <Section 4.3>

This function makes settings automatically such as vertical sensitivity, time axis and trigger settings, to suit the signal to be measured. This is useful when the signal to be measured is unknown. However, there might be particular signals for which the auto setup function may not work properly.

Storing and Recalling Setting Parameters <Section 4.4>

You can store setting parameters to the internal memory. The stored parameters can also be recalled to modify the settings on the instrument.

Snapshot <Section 4.6>

If single start is not selected, a waveform is updated at the specified intervals or is displayed in roll mode. Thus, to retain the currently displayed waveform, acquisition must be stopped. Use of the snapshot function allows the currently displayed waveforms to remain temporarily on the screen without acquisition being stopped. To activate this function, just press **SNAP SHOT** without stopping acquisition. The currently displayed waveform will be retained. This waveform is called a snapshot waveform. The snapshot waveform is displayed separately in white making comparison between the two easier. Snapshot waveforms are screen image data, so they cannot be used for cursor measurement or automated measurement. However, screen image data output (hard copy) is possible.

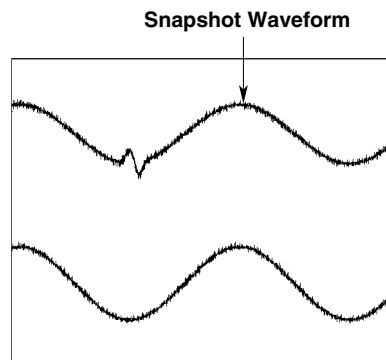
**Clear Trace <Section 4.6>**

This function clears all waveforms other than the loaded waveforms and restarts the averaging, repetitive sampling, and accumulation in a signal operation.

Preset <Section 5.6>

This feature automatically sets the V/div, input coupling, trigger level, and other parameters to appropriate values for 5-V or 3.3-V CMOS signals, or 700937, 701930, 701931, 701932, or 701933 current probes (Optional Accessories).

GO/NO-GO Determination <Section 9.9, 9.10>

The GO/NO-GO function is useful when you want to inspect signals and track down abnormal symptoms on a production line making electronic equipment. The NO (NOGO) condition is set (whether the waveform enters the previously specified range), and a certain operation is performed when the condition is met.

There are two methods in making the determination: a method in which a waveform zone is set on the screen and a method in which a waveform parameter range is specified. You can select from various actions for the NO-GO operation including sounding of a buzzer, saving of waveform data or screen image data, printing of screen image data, or transmission of e-mail messages (when the Ethernet interface option is installed). Also, you can output determination results signals externally on the GO/NO-GO determination output terminal.

Displayed Data Output Functions <Chapter 10>

You use these functions to print the screen image to the optional built-in printer, or an external USB printer or a network printer, to save the image data to the storage medium (internal flash memory, floppy disk, Zip disk, PC card, or network drive (Ethernet interface option)).

Also, the instrument can display a thumbnail (miniature sample) of the screen data saved to the storage medium. This is useful for checking the contents of saved image data files.

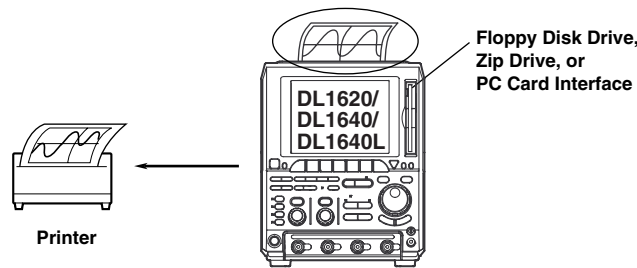

Note

The instrument provides a function which enables you to use the keyboard displayed on the screen or the USB keyboard to enter and display a comment. If you enter a comment which indicates the contents of the displayed waveforms before printing a hard-copy, it will help you to distinguish between different printouts.

Storage Medium Saves and Loads <Chapter 11>

The instrument standard configuration includes a floppy disk drive, Zip drive, or PC card, and the optional configuration includes an Ethernet connector. If you do not have a floppy disk, Zip disk, or PC card handy, you can use the 2-MB internal flash memory. In addition, a USB storage device (MO disk drive, hard disk, or flash memory) can be connected to the USB PERIPHERAL interface.

It is possible to save or load data on a floppy disk, Zip disk, PC card, internal flash memory, USB storage, or network drive.

You can save data in any of the following formats: PostScript, TIFF, BMP, JPEG, and PNG. This means that you can easily insert the saved images into documents produced with conventional DTP software packages.

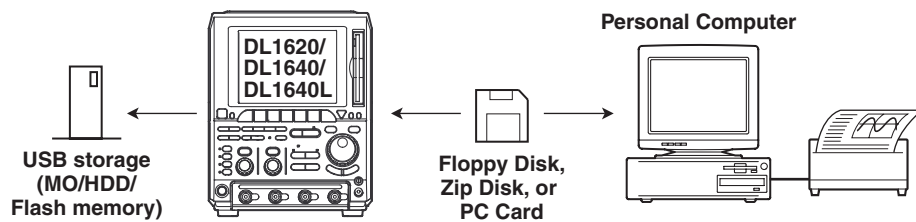

You can normally rewrite to the internal flash memory approximately 100000 times. However, this number can deteriorate and become less. Therefore, do not overly rewrite to the internal flash memory.

2.1 Front Panel/Rear Panel

Front View

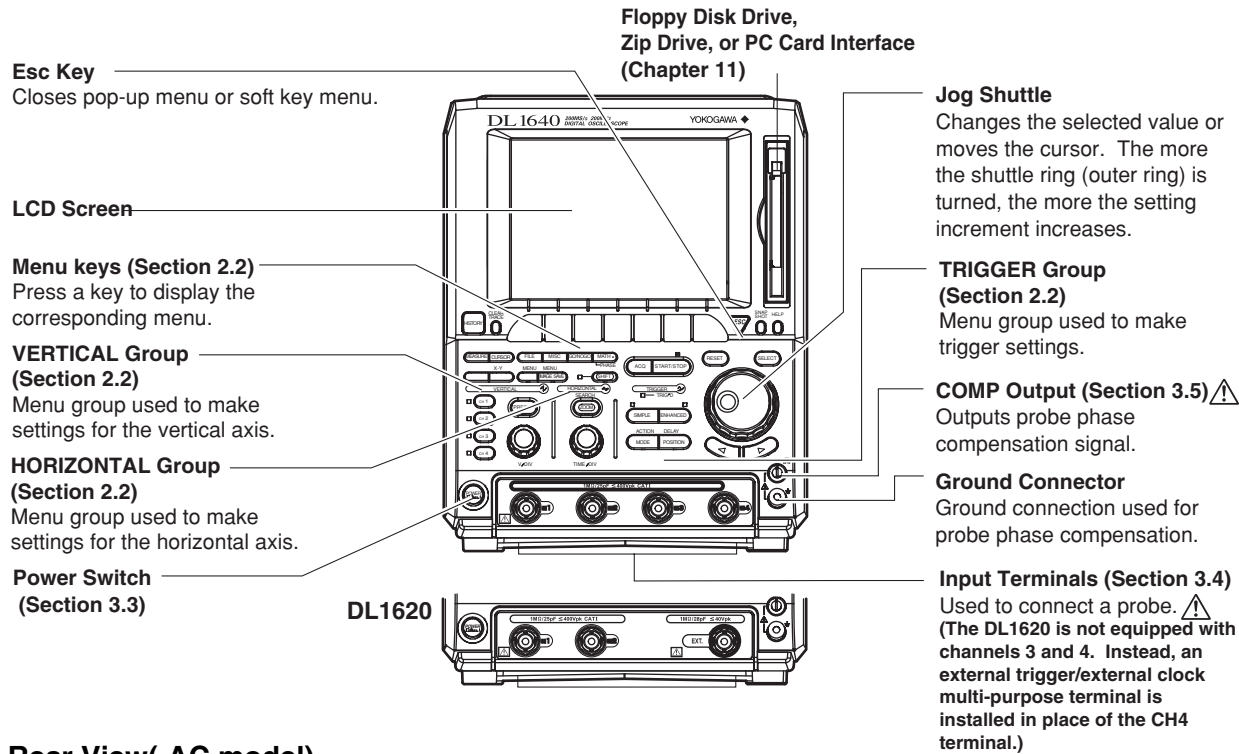

Rear View(-AC model)

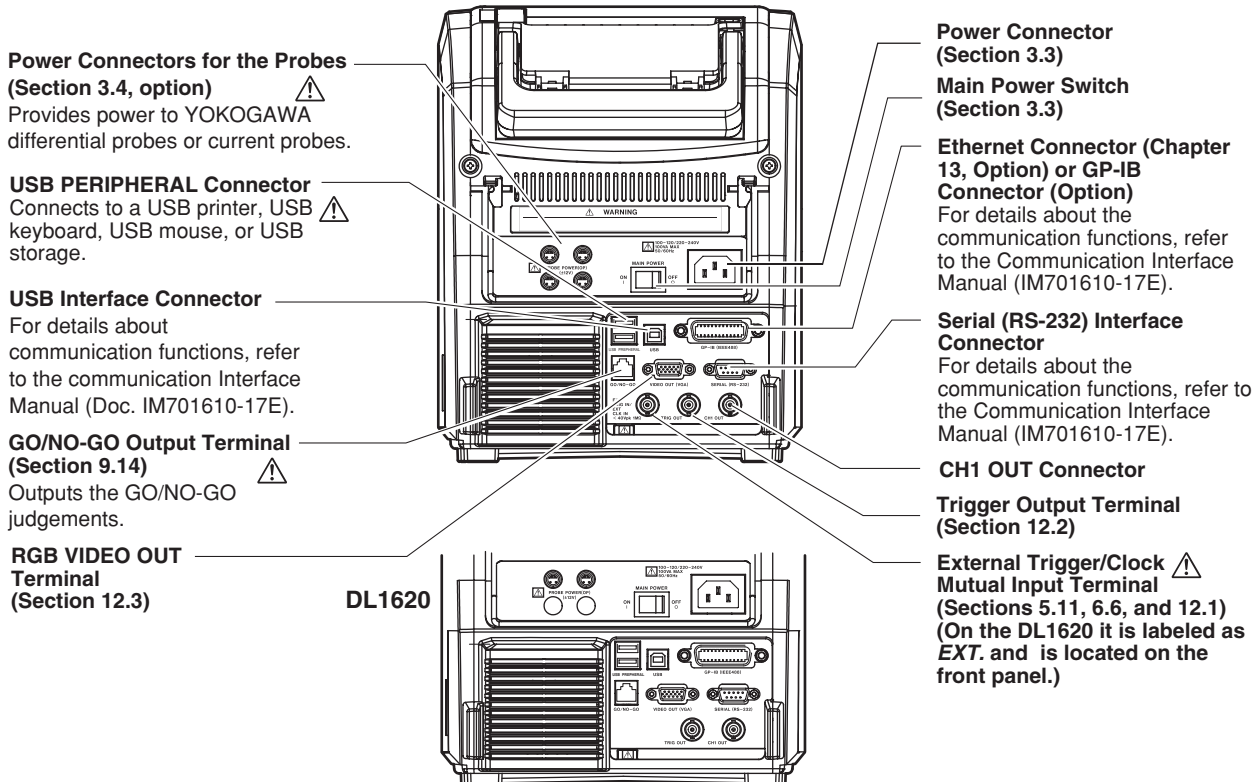

2.1 Front Panel/Rear Panel

Rear View(-DC model(701610/701620))

Power Connectors for the Probes
(Section 3.4, option) ⚠
Provides power to YOKOGAWA differential probes or current probes.

USB PERIPHERAL Connector ⚠
Connects to a USB printer, USB keyboard, USB mouse, or USB storage.

USB Interface Connector
For details about communication functions, refer to the communication Interface Manual (Doc. IM701610-17E).

GO/NO-GO Output Terminal
(Section 9.14) ⚠
Outputs the GO/NO-GO judgements.

RGB VIDEO OUT Terminal
(Section 12.3)

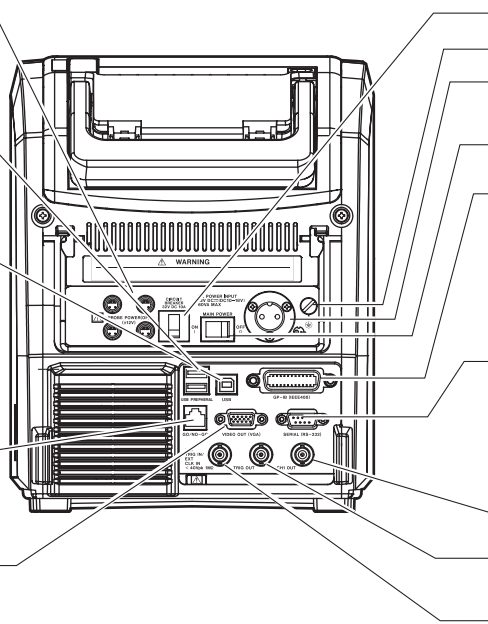

Circuit Breaker
Protective grounding Terminal
Power Connector
(Section 3.3)

Main Power Switch
(Section 3.3)
Ethernet Connector (Chapter 13, Option) or GP-IB Connector (Option)
For details about the communication functions, refer to the Communication Interface Manual (IM701610-17E).

Serial (RS-232) Interface Connector
For details about the communication functions, refer to the Communication Interface Manual (IM701610-17E).

CH1 OUT Connector

Trigger Output Terminal
(Section 12.2)

External Trigger/Clock Mutual Input Terminal ⚠
(Sections 5.11, 6.6, and 12.1)
(On the DL1620 it is labeled as EXT. and is located on the front panel.)

Top View

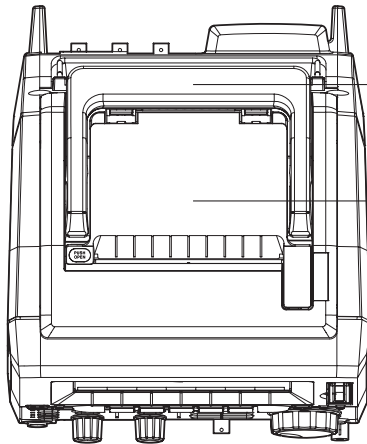

Handle
Use the handle to lift and carry the unit.

Built-In Printer (Option)

2.2 Operation Keys/Jog Shuttle/Knobs

VERTICAL Group

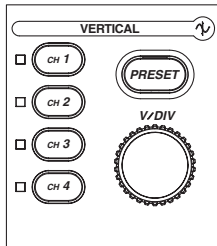

CH1 to CH4 Keys (Sections 5.1 to 5.5, 5.7 to 5.10)

On the DL1620, the CH3 and CH4 keys are disabled.

Displays a menu used to turn ON/OFF the display on each channel, set the vertical position, coupling, probe attenuation, offset voltage, bandwidth limit, inversion, expansion/reduction of the vertical axis, linear scaling, and waveform labels. In addition, by pressing this key before operating the V/DIV knob, the channel that is to be controlled by the V/DIV knob can be selected.

PRESET Key (Section 5.6)

Displays the preset menu that sets the V/div, input coupling, probe attenuation and trigger level to the optimum 5 V CMOS, 3.3 V CMOS, or the current probe (700937, 701930) (or preset level) automatically. This preset menu allows you to set all channels or the selected channels at once.

V/DIV Knob (Section 5.8)

Turning this knob during acquisition (i.e. while the START indicator is lit) sets the voltage axis sensitivity. Before turning this knob, be sure to select the channel you want to adjust by pressing the corresponding channel key (**CH1** to **CH4** (or CH1 and CH2 for the DL1620)).

HORIZONTAL Group

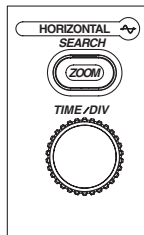

TIME/DIV Knob (Section 5.12)

Use this knob to set the time scale. If you change the scale while acquisition is suspended, the new value becomes effective when acquisition resumes.

(SHIFT +) ZOOM Key (Sections 8.9, 8.10)

Displays a menu related to the waveform zoom display.

Pressing the **ZOOM** key after pressing the **SHIFT** key displays a menu related to data searching (Search and Zoom Function).

TRIGGER Group

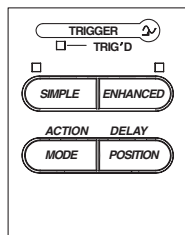

(SHIFT +) MODE Key (Sections 6.1, 6.15, 7.3)

Displays a menu used to select the trigger mode.

Pressing the **MODE** key after pressing the **SHIFT** key displays a menu related to action-on-trigger.

SIMPLE Key (Sections 6.4 to 6.7)

Displays the menu for the simple trigger mode, which provides normal triggers such as the edge trigger. Simple trigger mode is selected when the indicator located above this key is lit.

ENHANCED Key (Sections 6.4, 6.8 to 6.14)

Displays the menu for enhanced trigger mode, which provides complex triggers such as the pattern trigger. Enhanced trigger mode is selected when the indicator located above this key is lit.

(SHIFT +) POSITION Key (Sections 6.2, 6.3)

Used to set the trigger position.

You can set the trigger delay by pressing the **POSITION** key after pressing the **SHIFT** key.

TRG'D Indicator

Lights up when a trigger is activated.

Other Menus

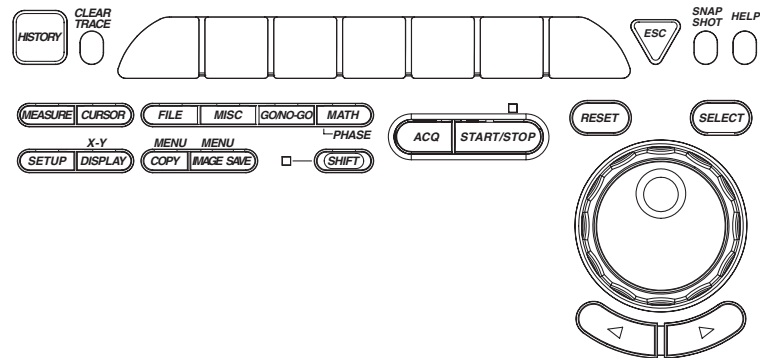

DISPLAY Key (Sections 8.1 to 8.8)

Displays the screen display menu.

Press **SHIFT + DISPLAY** to produce the menu for X-Y display setup.

MISC Key (Sections 3.6, 4.7, Chapters 13, 14, 15; IM701610-17E)

Displays the menu for selecting GO/NO-GO judgment, communication interface, system configuration settings, system status check, screensaver setting, and the self-diagnostic function.

FILE Key (Sections 11.5 to 11.13)

Displays the menus that you can use to save, load, or perform file operations with the internal flash memory, floppy disk, Zip disk, PC card, USB storage, network drive (when the Ethernet interface is installed).

(SHIFT+) COPY Key (Sections 10.2, 10.3, 13.5)

Used for printing out hard copy of the screen data.

If you press **SHIFT + COPY**, the screen displays a menu that you can use to print or save the screen image. For the save location, you can select any of the following: internal printer (option), and USB printer.

(SHIFT+) IMAGE SAVE Key (Sections 10.4, 13.4)

You can store the screen image to an external storage medium. Press the **SHIFT** key followed by the **IMAGE SAVE** key to display a menu used to save the screen image data to internal flash memory, a floppy disk, Zip disk, PC card, USB storage, or network drive (when the Ethernet interface is installed).

MEASURE Key (Sections 9.2 to 9.4)

Displays the menu for performing automatic measurement of waveform parameters.

CURSOR Key (Section 9.1)

Displays the menu for cursor measurement.

(SHIFT+) MATH Key (Sections 9.5 to 9.8)

Displays the menu for waveform computation.

Pressing the **MATH** key after pressing the **SHIFT** key displays a menu used to shift the phase.

GO/NO-GO Key (Sections 9.9, 9.10)

Displays a menu related to GO/NO-GO.

SETUP Key (Sections 4.2 to 4.4)

Displays a menu used to initialize the settings to factory defaults, perform auto setup, which automatically sets the DL1620/DL1640/DL1640L according to the input signal, store or recall setting parameters, and so on.

SHIFT Key

Used to make the functions that are marked in purple on the panel operative. Pressing this key activates shift mode, pressing it again releases shift mode. While the indicator above this key is lit, shift mode is active.

HISTORY Key (Sections 7.6 to 7.8)

Displays a menu used to recall data using the history memory function.

ACQ Key (Sections 5.11, 7.1, 7.2, 7.4, 7.5)

Displays the acquisition method menu.

START/STOP Key (Section 4.5)

Starts or stops acquisition according to the selected trigger mode. The indicator above this key is lit during acquisition.

Jog and Shuttle Dials (“jog shuttle”)

You use these dials to set numerical values, move the measurement cursors, select items from menus, and perform other such selection operations.

The jog dial changes the value in fixed steps as you rotate it. With the shuttle dial, the step size increases as you turn the dial further.

RESET Key

Resets values that you have changed using the jog and shuttle dials.

SELECT Key

Activates the menu item that you have highlighted using the jog or shuttle dial.

Arrow Keys (< > keys)

Use these keys to shift the column position of the numerical value to be set by the jog or shuttle dial.

SNAP SHOT Key (Section 4.6)

Repeats acquisition while retaining the currently displayed waveform on the screen.

CLEAR TRACE Key (Section 4.6)

Deletes the currently displayed waveform.

HELP Key (Section 4.8)

Sets help window ON or OFF.

Soft Keys

Selects the menu that is displayed at the bottom of the screen.

2.3 Screens

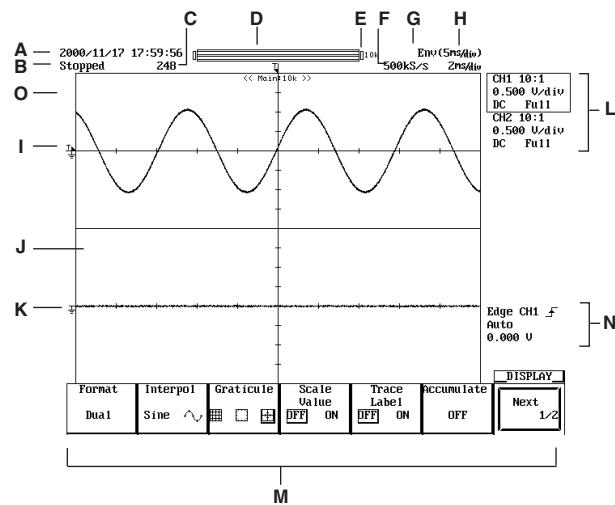

A Date and Time

For the procedures used to set the date and time, see section 3.6, "Setting the Date and Time."

B Operation State

Displays "Running" when data acquisition is in progress and "Stopped" when it is stopped.

C Waveform Acquisition State and the Number of Acquisitions

Waiting for Trigger : trigger wait state
 Pre... : pre-trigger
 Post... : post-trigger
 Value : the number of waveforms acquired

D Display Position

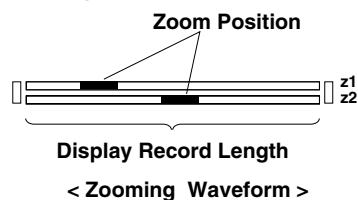

E Record Length

F Sample Rate

G Sampling Mode

Varies depending on the T/div and record length settings.

Normal/Env/Avg	Real-time sampling mode
Norm: Rep	Repetitive sampling mode
Avg: Rep	Repetitive sampling mode in the averaging mode

H T/div Setting that has been Changed after Waveform Acquisition

I Trigger Level

J Display Format

1, 2, and 4 windows are possible (or 1 and 2 windows for the DL1620). (See section 8.1)

K Ground Level

L Probe Attenuation, V/div, Input Coupling, and Bandwidth Limit Settings

If a signal exceeding approximately 10 div is input, the input coupling position overflow is indicated by a “#”.

M Soft Key Menu**N Trigger Level, Trigger Mode, Trigger Type, and Trigger Source Settings****O Internal Processing Status**

The current processing can be determined by the color of the “*”.

Green : Performing an operation (power spectrum) or overwriting a history waveform

Yellow : Performing an automatic parameter measurement or a search

Red : Sending e-mail, executing an FTP server function command, or HTTP command

Note

Up to 40 pixels per million of the color LCD may be defective.

3.1 Precautions During Use

Safety Precautions

When you are using this instrument, read “Safety Precautions” on page v thoroughly, as well as the following points.

Do not Remove the Cover from the Instrument

Some parts of the instrument use high voltages, which are extremely dangerous. When the instrument needs internal inspection or adjustment, contact your dealer or nearest YOKOGAWA representative, as listed on the back cover of this manual.

In Case of Irregularity

If you notice smoke or unusual odors coming from the instrument, immediately turn OFF the main power and unplug the power cord. If such an irregularity occurs, contact your dealer or the nearest YOKOGAWA representative as listed on the back cover of this manual.

Power Cord

Nothing should be placed on the power cord. Also, it should be kept away from any heat sources. When unplugging the power cord from the AC outlet, never pull the cord itself. Always hold the plug and pull it. If the power cord is damaged, contact your dealer. See page ii for the part number to use when placing an order.

General Handling Precautions

Observe the following precautions when handling the instrument.

Never Place Anything on Top of the Instrument

Never place other equipment or objects containing water on top of the instrument, otherwise a breakdown may occur.

Do not Cause Shock to the Input Connectors or Probes

Shock to the input connectors or probes may turn into electrical noise and enter the instrument via the signal lines.

Do not Damage the LCD Screen

Since the LCD screen is very vulnerable and can be easily scratched, do not allow any sharp objects near it. Also it should not be exposed to vibrations and shocks.

When the Instrument is not going to be Used for a Long Period

Unplug the power cord from the AC outlet.

3.1 Precautions During Use

Carrying the Instrument

Before carrying the instrument remove the power cord and other cables. Always carry the instrument by the handles or carry it with both hands (see below).

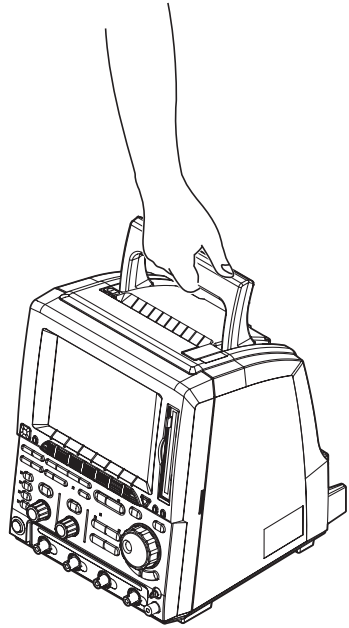

Cleaning

When cleaning the case or the operation panel, unplug the power cord from the plug first, then wipe with a dry, soft, clean cloth. Do not use volatile chemicals such as benzene or thinner for cleaning, as this may lead to discoloration or deformation.

3.2 Installation

Installation Conditions

The instrument must be installed in a place where the following conditions are met.

Flat Location

Set the oscilloscope in the proper direction and in a level and stable place. If placed in an unstable place, printing quality decreases.

Well-Ventilated Location

Vent holes are situated on the bottom. In addition, vent holes for the cooling fans are also situated in the rear sides. To prevent a rise in the internal temperature, the vent holes should not be blocked and sufficient clearance should be maintained around them. If a printer comes with your DL1620/DL1640/DL1640L, allow extra space for operation and do not place objects on top of the printer.

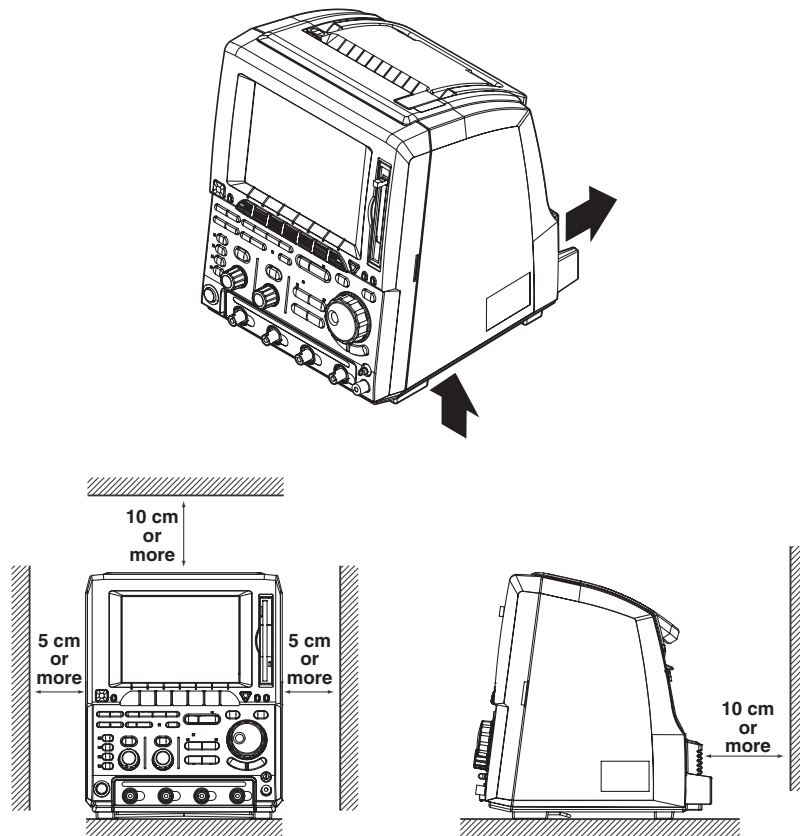

3.2 Installation

Ambient Temperature and Humidity

Ambient Temperature : 5 to 40°C

Ambient Humidity : 20 to 80% RH (when not using the printer)

35 to 80% RH (when using the printer)

No condensation should be allowed.

Note

- To ensure high measurement accuracy, the instrument should only be used under the following conditions.
Ambient temperature: 23 ±5°C
Ambient humidity: 55 ±10% RH
 - Internal condensation may occur if the instrument is moved to another place where both the ambient temperature and humidity are higher, or if the temperature changes rapidly. In such cases allow the instrument to acclimatize to its new environment for at least one hour before starting operation.
-

Never Install the Instrument in the Following Places

In direct sunlight or near heat sources

Where an excessive amount of soot, steam, dust or corrosive gases are present.

Near magnetic field sources

Near high voltage equipment or power lines

Where the level of mechanical vibration is high

In an unstable place

Installation Position

Place the instrument in a horizontal position or tilted using the stand, as shown below.

When you use the stand, pull it forwards until it locks. To return the stand to its original position, push it backwards. When installing the DL1620/DL1640/DL1640L with the rear panel down, use the stand on the rear panel.

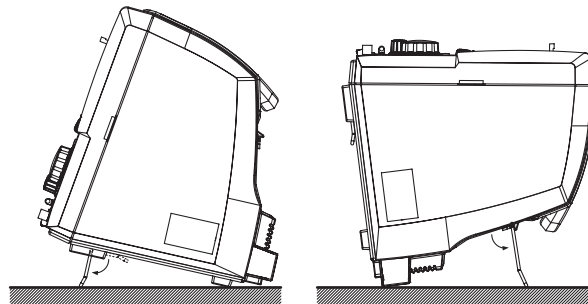

CAUTION

Do not use the Zip drive when the DL1620/DL1640/DL1640L is installed with the rear panel down.

Rubber Feet

If the instrument is installed in the tilted position, rubber feet can be attached to prevent slipping. Four pieces of rubber feet are included in the package.

3.3 Connecting the Power Cord

Before Connecting the Power

Make sure that you observe the following points before connecting the power. Failure to do so may cause electric shock or damage to the instrument.



WARNING

- Before connecting the power cord, make sure that the source voltage matches the voltage of the power supply and that it is below the rated voltage of the power cord.
- Connect the power cord after confirming that the instrument power switch is OFF.
- Always use protective ground to prevent electric shock. Connect the instrument power cord to the 3-prong power outlet with grounding terminal.
- Do not use non-grounding extension cords or other measures that defeat the protective grounding.
- Never use an extension cord that does not have a protective grounding, otherwise the protection feature will be invalidated.

Connecting the Power Cord(with the AC Power Model (-AC Suffix Code))

1. Make sure that main power switch and power switch are OFF.
2. Plug the power cord into the power connector socket on the rear panel of the instrument.
3. Plug the other end of the power cord into an AC outlet that meets the following conditions. The AC outlet must be of 3-prong type with a protective grounding terminal.

Rated supply voltage*:	100 to 120 VAC/220 to 240 VAC
Permitted supply voltage range:	90 to 132 VAC/198 to 264 VAC
Rated supply voltage frequency:	50/60 Hz
Permitted supply voltage frequency range:	48 to 63 Hz
Maximum power consumption (when the built-in printer is used):	100 VA

* The DL1620/DL1640/DL1640L can be used in 100-V and 200-V systems. Before using the DL1620/DL1640/DL1640L, make sure that the source voltage matches the voltage of the power supply and that it is below the rated voltage of the power cord (see page ii).

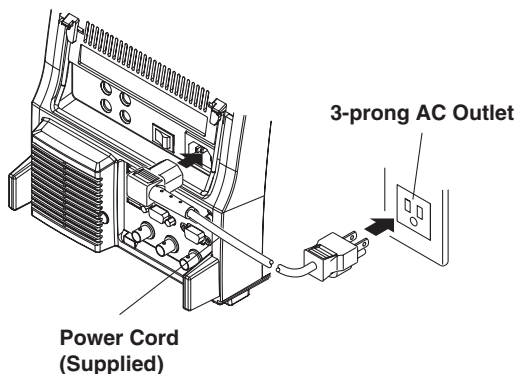

Connecting the Power Cord (with the DC Power Model (-DC Suffix Code))

When using the Battery Box (Model 701680, sold separately)

WARNING

- To avoid electric shock, ensure proper protective grounding of the DL1600.

When using the Yokogawa Battery Box (Model 701680), please refer to that instrument's user's manual.

When using a DC power supply other than the Battery Box (Model 701680)

WARNING

- To avoid electric shock, ensure proper protective grounding of the DL1600.
- To avoid electric shock, confirm that the power supply source is turned OFF before making connections.
- To avoid electric shock or fire, use a cable having a cross sectional area of 0.3 mm² (22 AWG) or more.

Attach the DC power supply and cable to the DC power supply connectors (part no. A1105JC) ahead of time, as shown in the figure below. Use a cable having a cross sectional area of 0.3 mm² (22 AWG) or more.

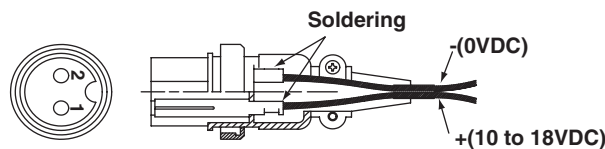

1. Check that the power switches on the instrument and DC power supply are turned OFF.
2. Connect the cable/connector assembled ahead of time according to the instructions above to the DC power supply connector on the instrument.
3. Connect the ends of the cable to a power supply meeting the conditions below.

Item	Conditions
Rated supply voltage	12 VDC
Operating supply voltage	10 to 18 VDC
Power consumption	60 VA max.

Note

- If the power supply voltage falls between 10 VDC and 11 VDC, a message appears on the DL1600 screen indicating that the power supply voltage is low.

Turning ON/OFF the Main Power Switch

Main power switch (rear panel on the right): Press the switch to the left to turn it ON; press the switch to the right to turn it OFF.

Turning ON/OFF the Power Switch

CAUTION

Do not turn the power ON or OFF when the Zip drive is installed, as this could damage the drive. To avoid damaging the Zip drive, remove it before turning the power ON or OFF.

Items to be Checked before Turning ON the Power

Check that the instrument is installed correctly as instructed in section 3.2, "Installation." Check that the power cord is connected correctly as shown in section 3.3, "Connecting the Power Cord."

Turning the Power ON/OFF

POWER switch: The power is turned ON and OFF alternately as the switch is pressed.

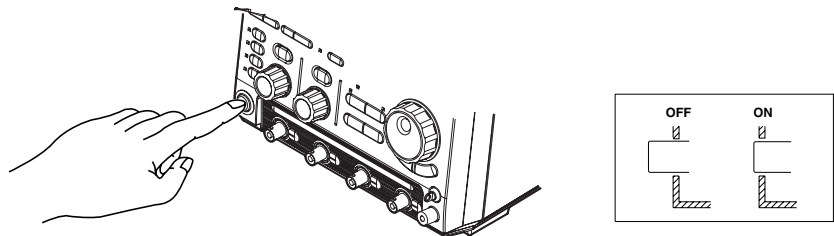

Note

- With the DC Power Model, if the main power is ON but the power does not turn on even if you turn on the power switch, the circuit breaker on the rear panel may be tripped. Reset the circuit breaker by following the procedure in section 15.5, "Resetting the Circuit Breaker."
- With the DC Power Model (with the -DC power supply specification), a shutdown may occur if the power supply voltage exceeds 19 VDC or falls below 9.5 VDC. In case of a shutdown, power cycle the unit using the power switch on the front panel (turn the power OFF, wait at least 10 seconds, then turn the power back ON again).

If the instrument still fails to start, turn OFF the power switch on the front panel, turn OFF the main power switch on the rear panel, then wait 10 seconds or more and turn the power back ON again.

Response at Power ON

Self test and calibration start automatically when the power switch is turned ON. If the check results are satisfactory, the normal waveform display screen will appear.

Note

- Wait at least 10 seconds after turning the power OFF before turning it back ON again.
- If calibration does not start when the power is turned ON, or if the normal waveform display screen does not appear, check the following points.
 - Check that the power cord is plugged in properly.
 - Check that the main power switch is turned ON.
 - Check that the correct voltage is being supplied from the AC outlet. (See section 3.3)

If there is still no power even after the above points have been checked, contact your nearest YOKOGAWA representative as listed on the back cover of this manual.

3.3 Connecting the Power Cord

For Accurate Measurement

Turn the power switches ON and allow the unit to warm up for at least 30 minutes.
After warm-up is complete, perform calibration. (See section 4.7)

Response at Power OFF

When you press the power switch to turn OFF the power, the power to the unit turns off only when access to the storage media is done. If you turn OFF the power when a Zip disk is inserted in the drive, the disk is ejected.

Settings made prior to turning OFF the power are retained (even if the power cord is removed). This allows display of waveforms using those saved settings the next time the power is turned ON.

Note

The settings are backed up by a lithium battery. The battery lasts for approximately 5 years if it is used at an ambient temperature of 23°C. When the battery voltage drops below the specified level, a message will appear on the screen. In this case, the battery needs to be replaced immediately. The battery cannot be replaced by the user, so contact the nearest YOKOGAWA representative listed on the back cover of this manual.

3.4 Connecting a Probe

Input Terminals

A probe (or an input cable such as a BNC cable) must be connected to one of the input terminals* (CH1 to CH4 (or CH1 and CH2 for the DL1620)) located on the lower section of the front panel.

The input impedance is $1\text{ M}\Omega \pm 1.0\%$ and approximately 28 pF.

* The number of input terminals varies according to the instrument model.



WARNING

To prevent fire or electric shock, do not use this instrument for category II, III, or IV measurements.



CAUTION

The maximum allowable input voltage is 300 VDC or 300 Vrms when the frequency is 1 kHz or less. Never input a voltage exceeding this level, as it could damage the input section of the instrument. If the frequency exceeds 1 kHz, the input section may be damaged even when the voltage is below 300 VDC.

DL1640/DL1640L

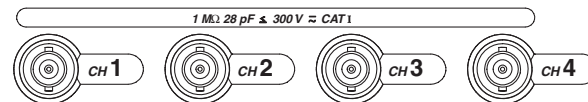

DL1620

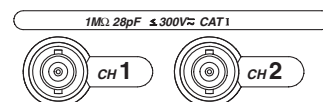

Points to Note when Connecting a Probe

- When connecting a probe to the instrument for the first time, perform phase correction of the probe as described in the section 3.5. Failure to do so may result in unstable gain across different frequencies, thereby preventing correct measurement. Calibration must be performed for each channel.
- If the object to be measured is connected to the instrument directly, without using a probe, correct measurement cannot be performed due to the load effect.

Probe

Specifications for the probe (700960) supplied with the instrument (after calibration)

Item	Specifications Setting 10 : 1	Setting 1 : 1	Conditions
Input impedance/ capacitance	10 MΩ ±2%, approx. 14 pF	1 MΩ ±1.0%, approx. 150 pF	When used with this instrument
Attenuation ratio	10 : 1 ±3%	—	When used with this instrument
Frequency band	DC to 200 MHz	DC to 6 MHz	When used with this instrument
Rise time	1.8 ns or less	58 ns or less	When used with this instrument
Maximum input voltage	600 V (DC + AC peak) ^{*1} or 424 Vrms, Frequency is 100 kHz or lower	—	
Connector type	BNC	BNC	—
Total length	1.5 m	1.5 m	—

*1 When the probe's attenuation is "1 : 1," never input voltage exceeding the maximum input voltage of this instrument.

When Using a Probe other than the One Supplied with the Instrument

- To measure a signal which contains harmonics of approximately 200 MHz, use a probe with a frequency band of 200 MHz or higher.
- Correct measured values cannot be displayed if the probe's attenuation ratio is not "1 : 1," "10 : 1," "100 : 1" or "1000 : 1."

Setting the Probe Attenuation

Follow the operating procedure given in section 5.4, "Selecting Probe Attenuation" so that the probe's attenuation matches the one displayed below **Probe** in the soft key menu. If they do not match, measured values cannot be read correctly.

When Using the Current Probe*, or the Differential Probe**

When using YOKOGAWA current probe or differential probe use the power supply for the probe provided on the rear panel of the instrument.

* Current probes made by YOKOGAWA: 700937, 701930, 701931, 701932, and 701933

** Differential probes made by YOKOGAWA: 700924, 700925, 701921, 701922



CAUTION

Use the power connectors for the probes on the rear panel only for the current probes or the differential probes. Using the power connectors for any other purpose can damage the DL1620/DL1640/DL1640L or the device that is connected.

Precautions to be Taken when Using the Current Probe or the Differential Probe

When connecting the current probe or the differential probe to the probe power supply terminal on the rear panel, make sure that the current does not exceed the range shown below. Otherwise, the DL1620/DL1640/DL1640L operation may become unstable due to the activation of the excessive current protection circuit.

DL1640/DL1640L

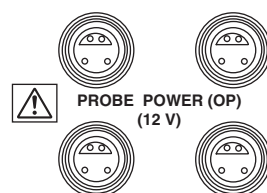

Total current consumption ≤ 450 mA

DL1620

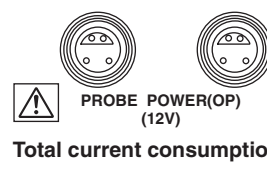

Total current consumption ≤ 450 mA

When using the current probe, the number of probes that can be used is limited by the current generated by the device under measurement. Examples of current consumption measurement using an active probe that can be connected to the DL1620/DL1640/DL1640L are shown below.

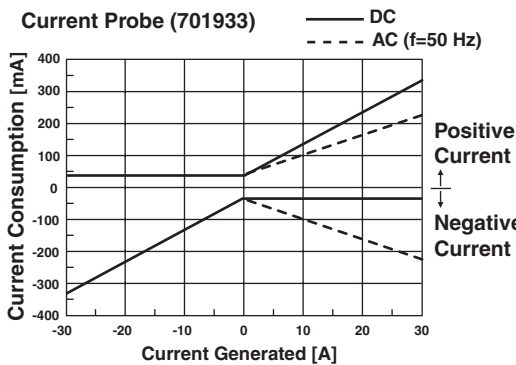
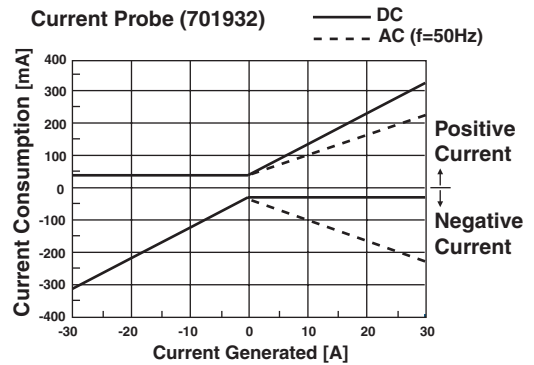
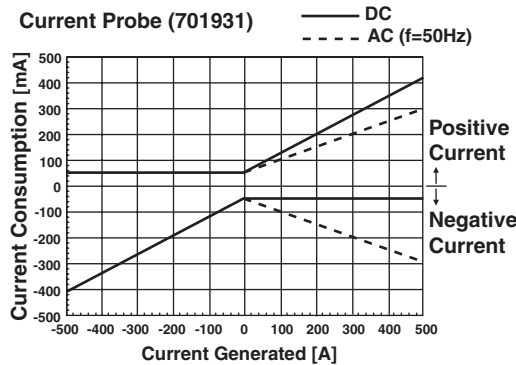
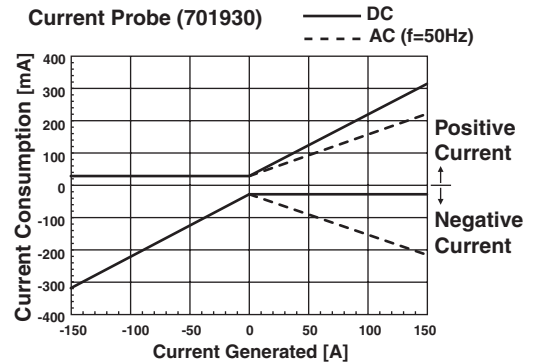
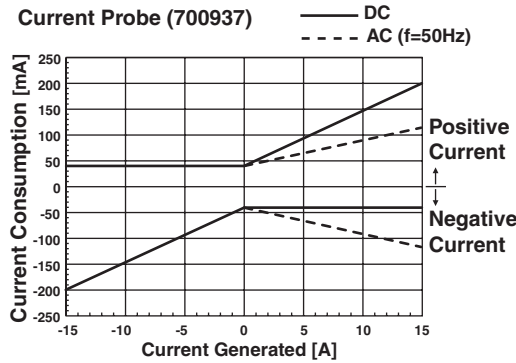

For details on the usage conditions of each probe, see "Relationship between the current being measured and probe's current consumption" on the following Web page.

<http://www.yokogawa.com/tm/probe/>

Calculate the positive and negative current consumption of the differential probe at a maximum of 125 mA.

3.5 Compensating the Probe (Phase Correction)



CAUTION

Never apply an external voltage to the COMP terminal, as damage to the instrument may result.

Operating Procedure

1. Turn ON the power switch.
2. Connect the probe to the input terminal to which the signal is to be applied.
3. Touch the probe's tip against the probe compensation signal output terminal and connect the grounding wire to the functional earth terminal.
4. Perform auto setup using the procedure described in section 4.3.
5. Insert a screwdriver into the phase adjusting hole in the probe and turn the trimmer so that the displayed waveform becomes square.

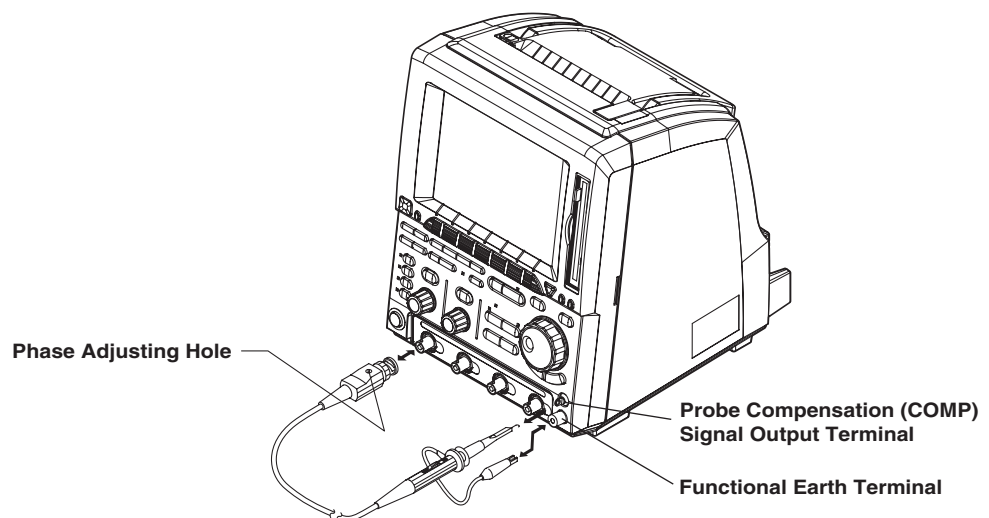

Explanation**Necessity of Phase Correction of the Probe**

When using the oscilloscope with a probe, the probe phase must be corrected by adjusting the variable capacitor inside the probe so that the gain is constant relative to the frequency. Measurements will not be accurate unless this adjustment is made, therefore you should make sure to perform this phase correction when using the probe for the first time.

The input capacitance differs depending on the oscilloscope. It can also vary slightly from channel to channel, even on the same oscilloscope. Even if the phase has been previously corrected, you must perform the correction again if you move the probe to a new oscilloscope or a different channel.

Calibration Signal

A probe compensation signal (square waveform) of the following characteristics is output from the CAL terminal on the front panel.

Frequency: approx. 1 kHz

Amplitude: approx. 1 V

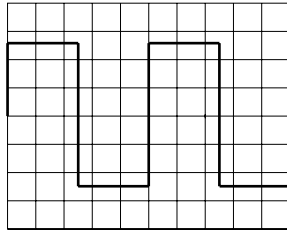
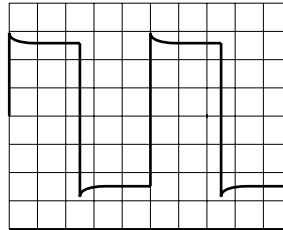
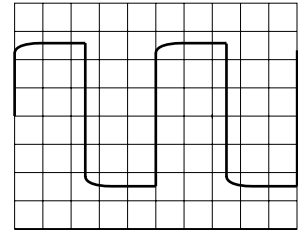
Waveform Differences**Correct Waveform****Over-Compensated
(Gain is too High at High Frequency)****Under-Compensated
(Gain is too Low at High Frequency)**

3.6 Setting the Date and Time

Relevant Keys

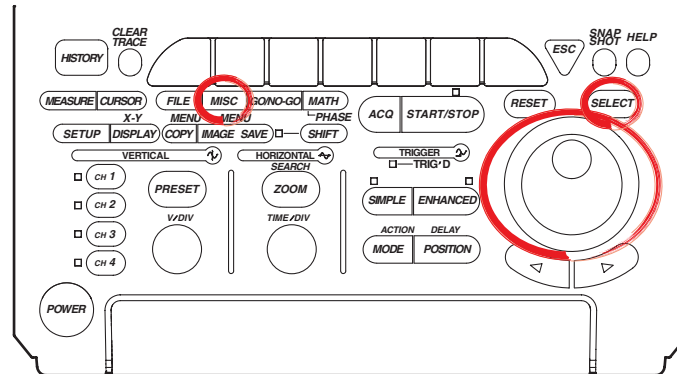

Operating Procedure

Displaying the System Configuration Menu

1. Press **MISC**.
2. Press the **System Cnfg** soft key to display the system configuration menu.

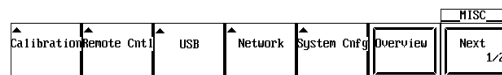

3. Press the **Date/Time** soft key to display the date and time display/setting menu.

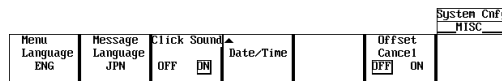

Turning ON/OFF the Date and Time Display

4. Select ON or OFF by pressing **SELECT**.

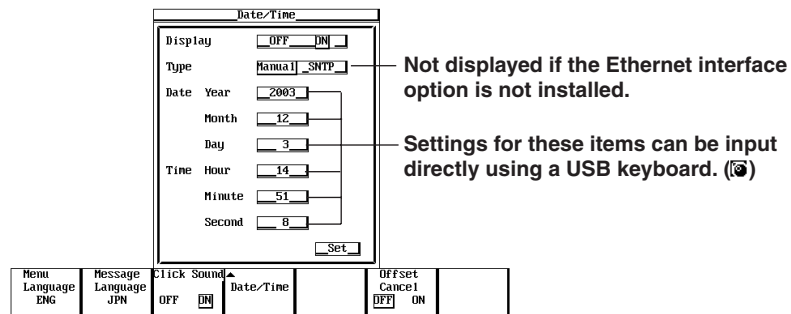

Proceed to step 5 to manually set the date and time, and to step 12 to obtain the time from the SMTP server.

Setting the date and time manually

5. Turn the jog shuttle to move the cursor to Type
6. Select Manual by pressing **SELECT**.
7. Turn the jog shuttle to move the cursor to Year.
8. Press **SELECT** to display the Year input box.
9. Set the year using the jog shuttle.
10. In a similar fashion, set the Month, Day, Hour, Minute, and Second.
11. Turn the jog shuttle to move the cursor to Set and press **SELECT** to confirm the settings.

Setting the Date and Time Using the SNTP Server (Optional, Version 1.13 or later)

To obtain the time from the SNTP server, you must first connect to the network, and then to the SNTP server. For details, see section 13.2, "Configuring the Ethernet Interface (TCP/IP)," and section 13.11, "Setting the Time Difference from the GMT (Greenwich Mean Time)/Setting SNTP."

12. Proceed to step 4, then turn the jog shuttle to move the cursor to Type.
13. Press **SELECT** to select SNTP.

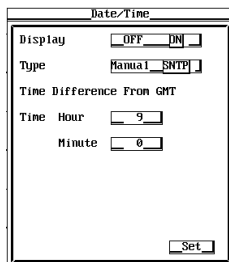

14. Turn the jog shuttle to move the cursor to Time Difference from the GMT and Time Hour.
15. Press **SELECT** to display the hour input box.
16. Use the jog shuttle to set the time difference from GMT (Greenwich mean time).
17. Set the minutes in the same manner.
18. Turn the jog shuttle to move the cursor to Set.
19. Press **SELECT** to obtain the time from the SNTP server. The time and date calculated from the entered GMT time difference is set.

Explanation**Date (YY / MM / DD)**

The last two digits of the year are used to set the year (YY).

Time (HH : MM : SS)

The 24-hour clock is used.

Setting the Time Using the SNTP Server

You can use the SNTP server time to set the date and time on the instrument.

This function is available on models with the Ethernet interface installed.

For information on SNTP and GMS, see section 13.11, "Setting the Time Difference from the GMT (Greenwich Mean Time)/Setting SNTP."

The difference from GMT set here is linked to the setting in section 13.11, "Setting the Time Difference from the GMT (Greenwich Mean Time)/ Setting SNTP."

Note

- The date and time are backed up by the built-in lithium battery.
- Leap years are taken into account.

4.1 Entering Values and Character Strings

Entering a Value

Direct Entry Using the Special Knob

The following knobs can be used to directly enter values simply by turning them. V/DIV and TIME/DIV knobs

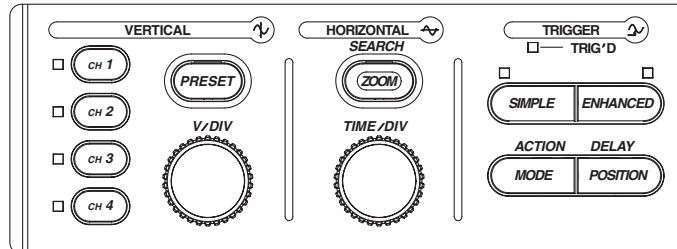

Entry Using the Jog Shuttle

Before using the jog shuttle to enter a value, you must select the desired parameter by pressing the corresponding soft key. The jog shuttle ring (the outer ring of the jog shuttle) allows you to enter values in larger steps than the jog shuttle dial. The size of the step depends on the angle by which the shuttle ring is turned. For some parameters you can use the arrow keys below the jog shuttle to shift from one digit to the next.

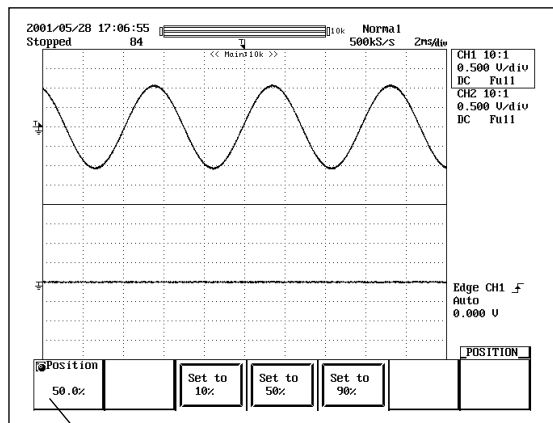

Parameter for Setting with the Jog Shuttle

Note

If you make an incorrect change with the jog shuttle, you can undo the change by pressing **RESET**.

Entering a Character String

The date/time, file name, and comment can be entered using the keyboard displayed on the screen. Operate the keyboard using the jog shuttle, the SELECT key and arrow key to enter a character string as follows.

Keyboard Operation

1. Turn the jog shuttle and move the cursor to the character you wish to enter. The ▲ and ▼ soft keys can be used to move the cursor up and down.
2. Press **SELECT** to confirm the character entry.
If a character string is already entered, use the arrow keys to move the cursor to the position at which you wish to enter the character.
3. Repeat steps 1 and 2 to enter all the characters.
4. ENT on the keyboard and press **SELECT**. The character string is confirmed and the keyboard disappears. The **ENT** soft key can be used to confirm the string (and hide the keyboard). At this point, the confirmed string is temporarily stored.)
If **RESET** is pressed before confirming the character string, the entire string is cleared.

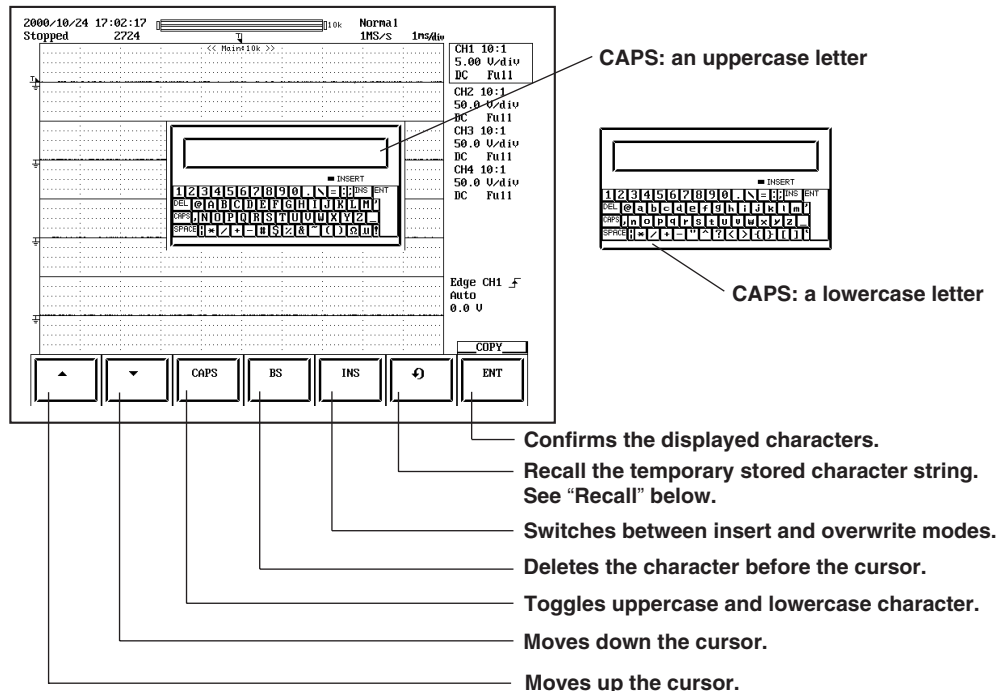

• Operation to Temporarily Store Character Strings

The strings that are previously confirmed are sequentially sent to the subsequent memories. When the number of confirmed strings exceeds eight, the strings are deleted in order starting from the oldest string. The 0 - 7 symbols are not displayed on the screen.

Symbol indicating the memory storing the string	0	1	2	7
When string "AA" is confirmed first	Stores AA				
When string "BB" is confirmed next	Stores BB	Moves and stores AA			
When string "CC" is confirmed next	Stores CC	Moves and stores BB	Moves and stores AA		
.....					
When string "HH" is confirmed next	Stores HH	Moves and stores GG	Moves and stores FF Moves and stores AA	
When string "JJ" is confirmed next	Stores JJ	Moves and stores HH	Moves and stores GG Moves and stores BB	Deletes AA

- **Recall**

(Note that the string that is displayed in the entry box of the keyboard is overwritten when a string is recalled using the procedure in step 1 below.)

1. When you press the ↶ soft key repeatedly, the eight most recently confirmed and stored strings are displayed one at a time from newest to oldest in the keyboard entry box. If the ↶ soft key is pressed again after the eighth string, the display will return to the first string.
2. Make appropriate corrections to the recalled string and confirm it according to steps 1 to 4 that were described above in “Entering a Character String,” and “Operation to Temporarily Store Character Strings.” At this point, the confirmed string is temporarily stored.

Keys other than Characters

- DEL: Deletes the character on the cursor.
- INS: Switches between insert and overwrite modes. The indicator is lit when in insert mode.
- SPACE: Enters a space.
- ENT: Confirms the displayed characters.
- CAPS: Toggles uppercase and lowercase characters.

Number of Characters and Types Available

Number of Characters	Available Characters	
Date, time	Specified number	0 to 9 (/ :)
File name	1 to 16	0 to 9, A to Z, %, _, (,), -
Display image comment	0 to 20	All characters (including space)
File comment	0 to 25	All characters (including space)
Mail address	0 to 40	All ASCII characters on the keyboard (including space)
User name/Login name	0 to 15	All ASCII characters on the keyboard (including space)
Password	0 to 15	All ASCII characters on the keyboard (including space)

Note

- Comments and file names can both contain both uppercase and lowercase letters. However, file names are *not* case sensitive. The following file names are not allowed due to MS - DOS restrictions.
AUX, CON, PRN, NUL, CLOCK, COM1 to COM9, LPT1 to LPT9
- You cannot enter two or more atmarks (@) in succession.

Connecting a USB Keyboard

You can connect a USB keyboard for entering file names, comments, and other information. In addition, the keys on the keyboard are assigned to the keys on the front panel of the DL1620/DL1640/DL1640L, which allows you to operate the DL1620/DL1640/DL1640L in a similar fashion. (See Appendix 5.)

USB PERIPHERAL Connector

When connecting a USB keyboard to the DL1620/DL1640/DL1640L, connect a USB cable to the USB PERIPHERAL connector. There are two USB PERIPHERAL connectors.

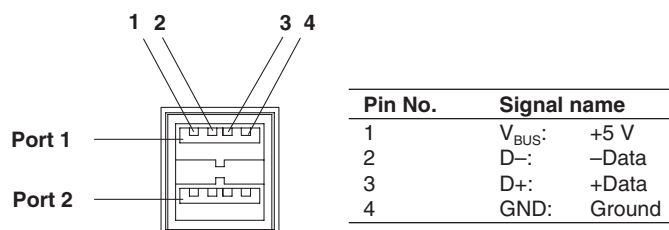

4.1 Entering Values and Character Strings

Keyboards that can be Used

The keyboards that can be used depend on the language that you selected in section 14.5 (English or Japanese). A 104 USB keyboard (English) or a 109 USB keyboard (Japanese) that conforms to USB Human Interface Devices (HID) Class Ver. 1.1 can be used.

- When the language is English: 104 keyboard
- When the language is Japanese: 109 keyboard

The default language is English.

Note

- Connect only the keyboards that are allowed. However, operation of USB keyboards connected to a USB hub or those that have mouse connectors is not guaranteed.
 - For USB keyboards that have been tested for compatibility, contact your nearest YOKOGAWA dealer as listed on the back cover of this manual.
-

Connection Procedure

When connecting a USB keyboard, directly connect the keyboard to the DL1620/DL1640/DL1640L with a USB cable as shown below. You can connect the USB cable regardless of the power ON/OFF state of the DL1620/DL1640/DL1640L (supports hot-plug). Connect the type A connector of the USB cable to the DL1620/DL1640/DL1640L; connect the type B connector to the keyboard. When the power switch is ON, the keyboard is detected and enabled approximately 6 seconds after it is connected.

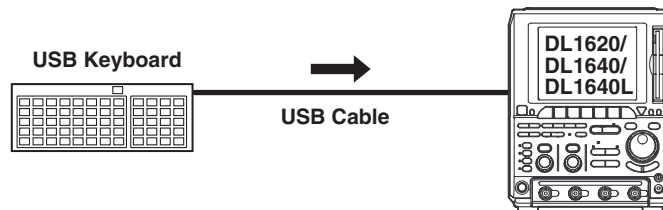

Note

- Connect the keyboard directly without going through a USB hub.
 - Connect only a USB keyboard, printer, or mouse to the USB PERIPHERAL connectors.
 - Do not connect multiple keyboards. Do not connect more than one keyboard, printer, or mouse at one time.
 - Even if you continuously depress a key the character will not be input repeatedly.
-



Entering File Names, Comments, etc.

When the soft keyboard is displayed on the screen, you can enter the file name, comment, and so on using a USB keyboard. The character that is entered through each key of the keyboard varies depending on the keyboard type. For details, see Appendix 5.

Executing Functions Corresponding to the Keys on the Front Panel of the DL1620/DL1640/DL1640L

The functions corresponding to the keys on the front panel of the DL1620/DL1640/DL1640L are assigned to the keys on the USB keyboard. By pressing the keys on the keyboard, you can operate the DL1620/DL1640/DL1640L in a similar fashion. The assignment of functions varies depending on the keyboard type. For details, see Appendix 5.

Entering Numerical Values Using a USB Keyboard

Numerical values for menu items preceded by the  or  symbol can be input directly using a USB keyboard.

Display	Position	Coupling	Probe	Offset	Bandwidth	CHI
OFF	0.00div	DC	10:1	0.000 U	Full	Next 1/2

Press the corresponding soft key, enter the values with the USB keyboard, then press the Enter key. The entered values are displayed in the upper part of the screen.

- **Inputting a Units Prefix**

If unit prefixes are displayed (such as m for Offset in the example above), you can input the character for the prefix as well as the numerical value using the USB keyboard. Prefixes can be entered for units of voltage (V) and time (s). Also, the prefixes that can be used are determined by the allowable input range.

Input Example

- If you type 1 then Enter for the Offset, this means 1 V so 1000 mV is displayed on the screen.
- If you type 1, 0, then m, this means 10 mV so 10 mV is displayed on the screen. If you enter a prefix for the units, it is not necessary to press the Enter key.

The available unit prefixes are as follows:

Key	Prefix
K or k	10^3
m	10^{-3}
U or u	10^{-6}
N or n	10^{-9}
P or p	10^{-12}

Operations Using a USB Mouse

You can use a USB mouse to operate the DL1620/DL1640/DL1640L as you would using the front panel keys. In addition, you can point to the desired item on a menu and click it. This is similar to pressing the soft key corresponding to a menu and pressing the SELECT key.

USB PERIPHERAL Connector

The USB mouse is connected to the USB PERIPHERAL connector on the left side panel of the DL1620/DL1640/DL1640L. For details on the USB PERIPHERAL connector, see page 4-3.

USB Mouse Models That Can Be Used

A USB mouse (with a wheel) conforming to USB HID Class Ver.1.1. can be used.

Note

- For USB mouse models that have been tested for compatibility, contact your nearest YOKOGAWA dealer as listed on the back cover of this manual.
 - Some items cannot be specified when using a mouse without a wheel.
-

Connection Procedure

When connecting a USB mouse, connect the mouse directly to the USB PERIPHERAL connector as shown below. You can connect/disconnect the USB mouse regardless of whether the DL1620/DL1640/DL1640L is ON or OFF (supports Hot Plug). When the power is turned ON, the mouse is detected and enabled approximately 6 seconds after it is connected.

Note

- Do not connect USB devices other than a USB keyboard, USB mouse, or USB printer to the USB PERIPHERAL connector.
 - There are two USB PERIPHERAL connectors on the DL1620/DL1640/DL1640L. However, do not connect two mice to both connectors at the same time.
-

Confirming the Type of USB Mouse that is Connected

The procedure to confirm the type of USB mouse connected to the DL1620/DL1640/DL1640L is the same as the procedure to confirm the type of USB keyboard. See page 4-4.

USB Mouse Operation

- **Operations Similar to the Front Panel Keys on the DL1620/DL1640/DL1640L (Top Menu)**

Displaying the Top Menu

Right-click the screen. The front panel keys on the DL1620/DL1640/DL1640L are displayed as the top menu.

Selecting Items on the Top Menu

Point to the item that you wish to select and click the item. The setup menu corresponding to the selected item is displayed at the bottom of the screen. The top menu disappears.

Pointing to an item with a submenu (items with a ">" mark displayed to the right) displays the submenu. As with the top menu, point to the item that you wish to select and click the item.

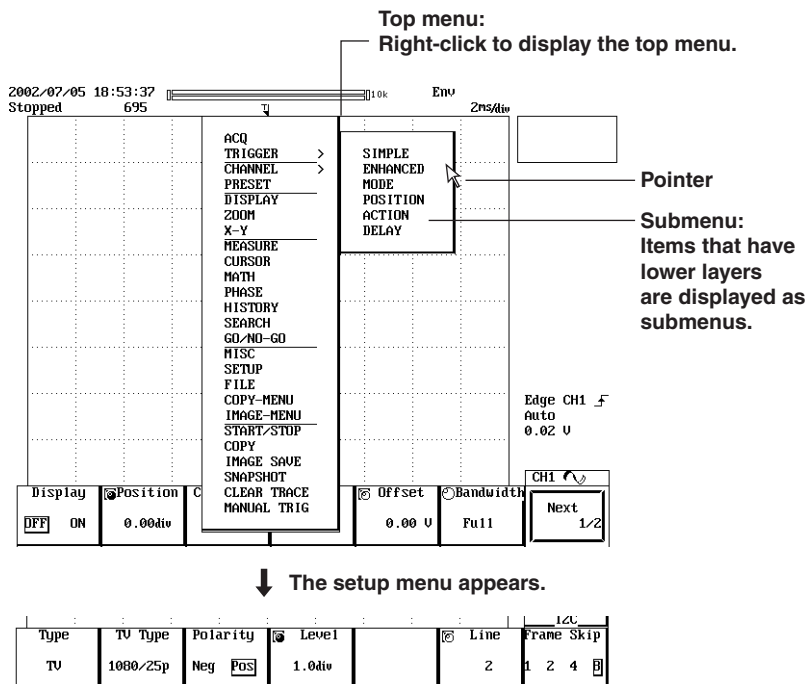

Note

- The following keys do not appear on the top menu. ESC, RESET, SELECT, HELP, and arrow keys
- The top menu also displays characters that are indicated in purple on the front panel.
- The TRIGGER submenu contains the following TRIGGER group keys. MODE, SIMPLE/ENHANCED, POSITION, ACTION, and DELAY
- There is no MANUAL TRIGGER key on the front panel.
- To display the COPY menu or the IMAGE SAVE menu, select COPY-MENU or IMAGE-MENU. To execute the COPY or IMAGE SAVE operation, select COPY or IMAGE SAVE.

4.1 Entering Values and Character Strings

- **Setup Menu Operation (Similar to the Soft Key Operation)**

Selecting an Item on the Setup Menu

Click the item that you wish to select on the setup menu.

If another menu appears when you select an item, move the pointer to the new frame displaying the item that you wish to select and click the item.

If an item such as ON or OFF appears when you select an item, move the pointer to the new frame containing the item and click the item. This operation switches the item.

For menus on which items are selected using the jog shuttle and SELECT, click the desired item. Click again to confirm the new setting and close the selection dialog box. For items through which you can scroll, turn the mouse wheel to scroll.

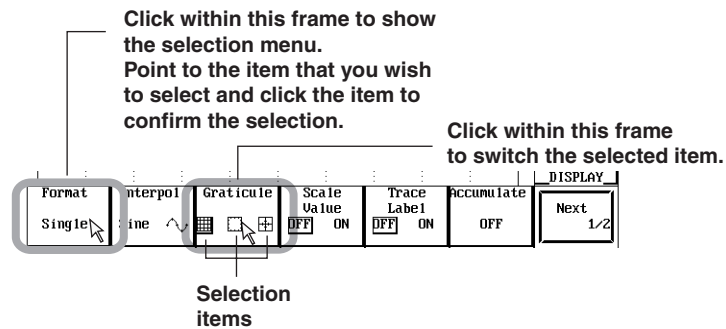

Clearing the Menu Screen

Click anywhere outside the menu screen.

- **Setting Values**

For menu items with a or icon, numeric values can be entered as follows:

- To select a menu item with a or icon, click the center of the menu item. If there are two setup items in a single menu item, you can click either item.
- Turn the mouse wheel away from you to increase the value.
- Turn the mouse wheel toward you to decrease the value.
- To move to a different digit, click the left or right of the value. At this point, the pointer changes to or . If you point to the left and click, the current digit moves to the left; if you point to the right and click, the current digit moves to the right. The current digit moves one digit at a time for each click.
- To reset the value to its default, right-click the desired menu item.

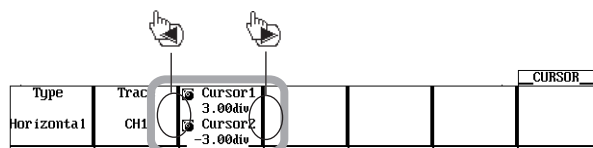

Moving the pointer in this area causes the pointer to change.
Click to move the current digit. Right-click to reset the value to its default.

- **Selecting Toggle Box Items in the Dialog Box**

- Click the item that you wish to select. The item is selected. Click the selected item again to deselect it.
- To close the dialog box, click anywhere outside the dialog box.

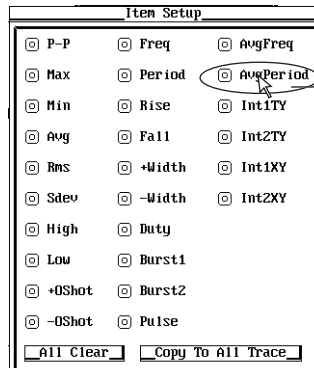

Click the item that you wish to select.

Note

To close an error dialog box, click anywhere outside the error dialog box.

- **Selecting a File, Directory, or Medium Drive in the File List Window**

- Click a file, directory, or medium drive name to select it.
- If a scroll bar appears in the file list window, you can turn the mouse wheel to scroll through the file list.
- To cancel the selection, click anywhere outside the file list window. The selection is cancelled and the file list window closes.

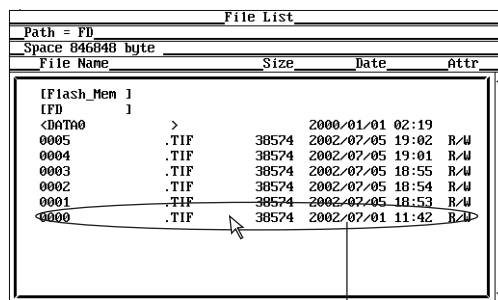

Scroll bar

Click the file, directory, or storage medium drive that you wish to select.

4.1 Entering Values and Character Strings

- **Setting V/DIV and TIME/DIV**

Setting V/DIV

When the waveform of a channel measuring voltage is displayed, point near the V/DIV value displayed at the upper-left corner of the screen. The pointer changes to . Click the V/DIV value for the channel that you want to set. The selected V/DIV value is framed in a box. Turning the mouse wheel away from you increases the V/DIV value; turning it toward you decreases the V/DIV value.

Setting TIME/DIV

Point near the TIME/DIV value displayed at the upper-right corner of the screen. The pointer changes to . Turning the mouse wheel away from you increases the TIME/DIV value; turning it toward you decreases the TIME/DIV value.

Moving the pointer to the position indicated below changes the pointer. You can change the V/DIV or TIME/DIV setting by turning the wheel.

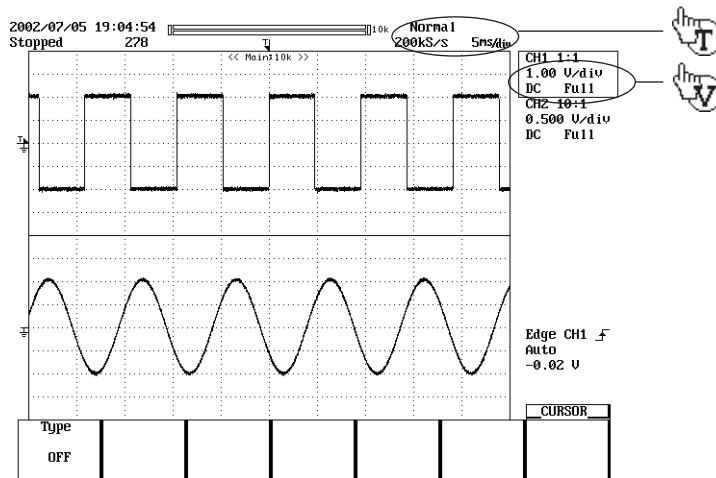

4.2 Initializing Settings

Relevant Keys

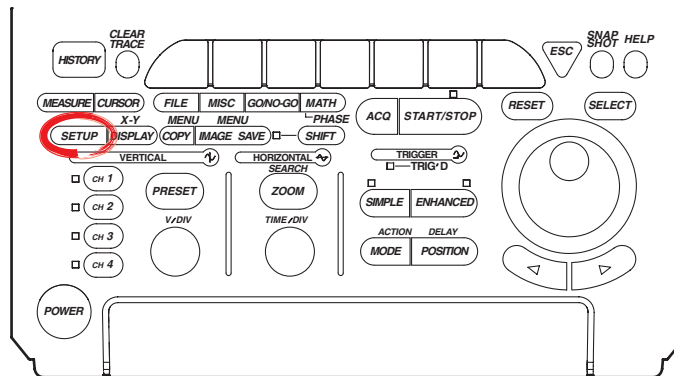

Operating Procedure

Performing Initialization

1. Press **SETUP**.
2. Press the **Initialize** soft key to start initialization.

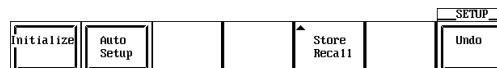

Canceling Initialization

3. Press the **Undo** soft key. This will restore the previous settings that were in effect before initialization.

Note

The Undo operation remains available only while power stays on. The setting parameters that existed immediately before initialization are cleared if you execute auto setup after initialization.

Explanation

The initialization function allows you to reset parameter values which have been set using panel keys to the default (factory settings). This is very convenient when you have to cancel the previous settings or when you have to restart measurement from the beginning.

Initialization

Initialization means resetting parameters to their factory setting values. For details on factory settings, see the Appendix.

Settings which cannot be Initialized

Date and time

Communication or ethernet interface related settings

Setting parameters on storing and recalling function

Setting the message language (English or Japanese)

Internal flash memory

Canceling Initialization

If you have performed initialization by mistake, press the **Undo** soft key. This will restore the previous settings used before the initialization was performed.

Initializing All Settings

Turning the power switch ON while holding down **RESET** will start initialization. This also initializes settings relating to the communication or ethernet interface, settings stored to the internal memory using the store/recall function, and so on. If settings are initialized using this method, you will not be able to restore the previous settings.

4.3 Performing Auto Setup

Relevant Keys

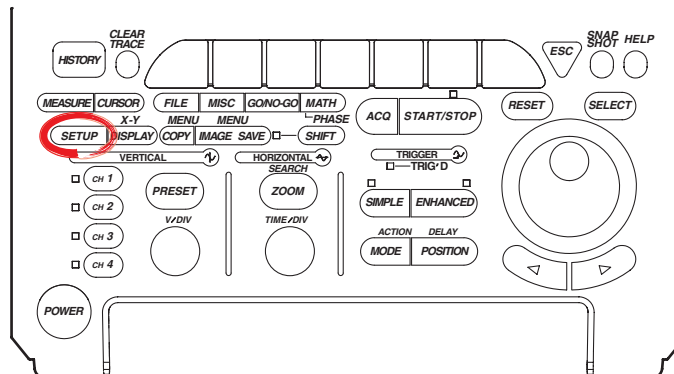

Operating Procedure

Performing Auto Setup

1. Press **SETUP**.
2. Press the **Auto Setup** soft key to perform auto setup.
When auto setup is executed, waveform acquisition starts automatically.

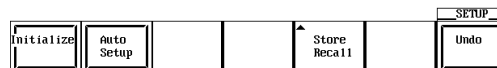

Canceling Auto Setup

3. Press the **Undo** soft key to restore the settings that existed immediately before auto setup.

Explanation

The key settings such as V/div, T/div, and trigger levels are automatically set to optimum values for the input signal.

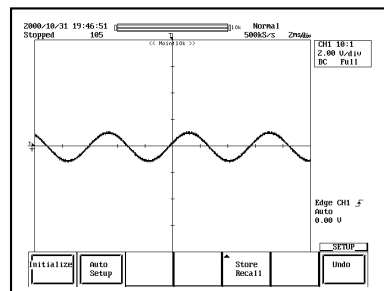

Before Auto Setup

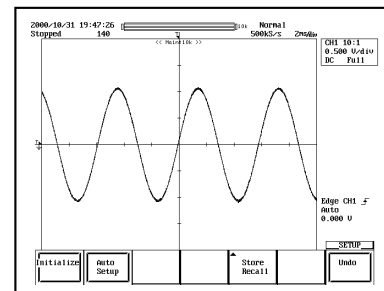

After Auto Setup

Center Position

The center position after auto setup is set to 0 V.

Target Channels

Auto setup is performed on all channels.

Loaded Waveforms

When you perform auto setup, the loaded waveforms are unloaded. (Pressing the Undo soft key has no effect.)

4.3 Performing Auto Setup

Canceling Auto Setup

By pressing the **Undo** soft key, the settings can be set back to the values that existed immediately before auto setup was performed. However, settings which existed before auto setup are erased when the power is turned OFF. In this case, the Undo operation will have no effect. The setting parameters that existed immediately before auto setup are cleared if you execute initialization after auto setup.

Waveforms that can be Automatically Setup

Frequency: Approx. 50 Hz or more
Maximum Absolute Input Value: Approx. 20 mV or more (assuming 1 : 1 probe attenuation)
Type: Repetitive waveforms that are not complex
When the input coupling is set to "DC."

Note

The auto setup function may not operate properly in some cases such as when the waveform contains a large DC offset or high-frequency components.

Settings Made by Auto Setup

Waveform Acquisition and Display

Acquisition Mode	Normal
Acquisition Count	Infinite
Record Length	10 k
High-resolution Mode	OFF
Timebase	Int
Accumulation Mode	OFF
Zoomed Waveforms	Traces set ON for display

Vertical Axis Settings

V/div	Set to a value so that the absolute value of the input waveform is between 1.6 div to 4 div. (approximately)
Offset Voltage	0 V (If Adjust Mode is 0 V)
Coupling	DC
Bandwidth	FULL
Display ON/OFF	Turns ON the channels of which the absolute value of the amplitude is at least 20 mV (1 : 1)
Position	0 div

Horizontal Axis Settings

T/div	Set so that screen displays 1.6 to 4 periods of the auto setup waveform with the shortest period.
-------	---

Trigger Settings

Trigger Mode	Auto
Trigger Type	Simple
Trigger Source	Channel with the longest period and an amplitude of at least 1 div
Trigger Level and Slope	Level is 1/2 the trigger source amplitude. Slope is "rising."
Trigger Coupling	The center level of the maximum and minimum values/ rising
HF Rejection	OFF
Hysteresis	
Holdoff Time	80 ns
Trigger Position	50%
Trigger Delay	0 s

Math Setting

Scaling	Auto
---------	------

Automatic setup affects only the settings listed above. All other settings remain unchanged.

4.4 Storing and Recalling Setting Parameters

Relevant Keys

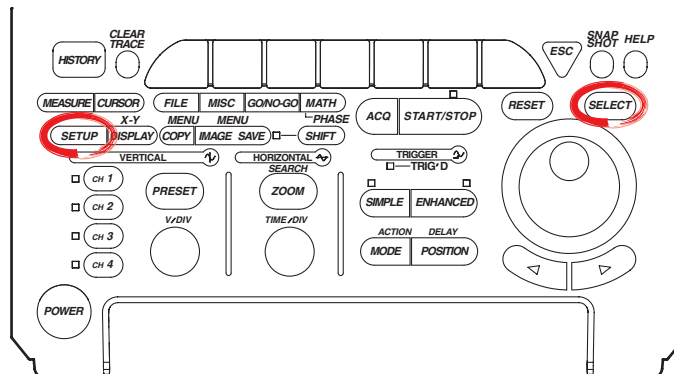

Operating Procedure

1. Press **SETUP**.
2. Press the **Store Recall** soft key.

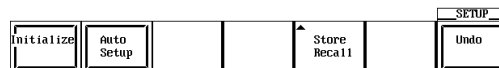

Recalling

3. After step 2, press the soft key corresponding to the memory number to be retrieved (**Recall #1** through **Recall #3**) to execute the recall operation.



Storing

3. After step 2, press the soft key corresponding to the memory number to be stored (**Store #1** through **Store #3**) to execute the store operation. The execution date of the store operation is also displayed.



4. Press the **Store Detail** soft key to display the details of the store operation. To enter a comment, follow the procedure described in section 4.1, "Entering a Character String."

There is a lock switch that you can use to prevent (lock) overwriting of the stored data. Turn the jog shuttle to move the cursor to the lock button corresponding to the store number that you wish to lock. Press **SELECT** to lock the data. Press **SELECT** again to release the lock.

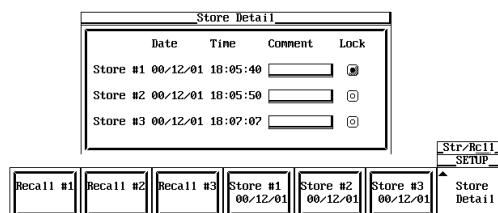

4.4 Storing and Recalling Setting Parameters

Explanation

Items that are Stored

Stores all information that you entered using the soft key menu or jog shuttle menu, START/STOP, and the ON/OFF conditions of channels.

Selecting the Storage Destination of the Setting Parameters

You can store the setting parameters to three memory locations, Store #1 through Store #3. If the setting parameters are already stored to the selected number, the previous data is overwritten. However, an error message is displayed if the data is locked.

Selecting the Setting Parameters to be Recalled

Select the setting parameters that are stored in the three memory locations, Recall #1 through Recall #3. You can only select memory locations that have setting parameters stored.

Note

- The stored setting parameters are not cleared even if you initialize the settings on the DL1620/DL1640/DL1640L.
 - A waveform stops loading when its setting parameters are recalled.
-

4.5 Starting/Stopping Waveform Acquisition

Relevant Keys

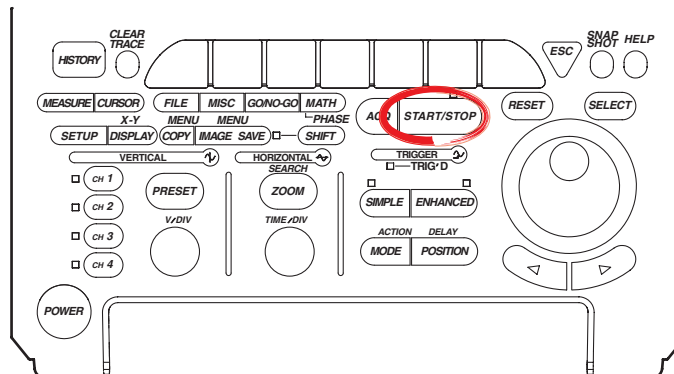

Operating Procedure

1. Pressing **START/STOP** starts or stops the waveform acquisition. Waveform acquisition is in progress when the indicator above the key is lit.

Explanation

START/STOP is pressed when starting or stopping waveform acquisition.

- When the indicator to the upper right of **START/STOP** is ON, waveform acquisition is started.
- When the indicator to the upper right of **START/STOP** is OFF, waveform acquisition is stopped. Stopped is displayed on the upper left corner of the screen.

Operation when the Acquisition Mode is Set to Averaging Mode

- When the waveform acquisition is stopped, the averaging process also stops.
- When the waveform acquisition is restarted, a new averaging process starts.

START/STOP Operation while Accumulation is in Progress

When the waveform acquisition is stopped, accumulation is interrupted. When the waveform acquisition is restarted, a new accumulation starts.

Conditions in which the START/STOP is Disabled

- When the instrument is in the remote mode, controlled via communication.
- When the instrument is printing or auto setup is in progress.

Note

- Pressing **FILE** or **HISTORY** while the waveform acquisition is in progress stops the waveform acquisition.
- If the waveform acquisition conditions are changed and the acquisition is restarted, previously acquired data are cleared.
- The snapshot function can also be used to retain the waveforms that are currently displayed on the screen. The display can be updated without having to stop the waveform acquisition (see next section).

4.6 The Snapshot and Clear Trace Functions

<For a description of this function, see pages 1-31 and 1-32>

Relevant Keys

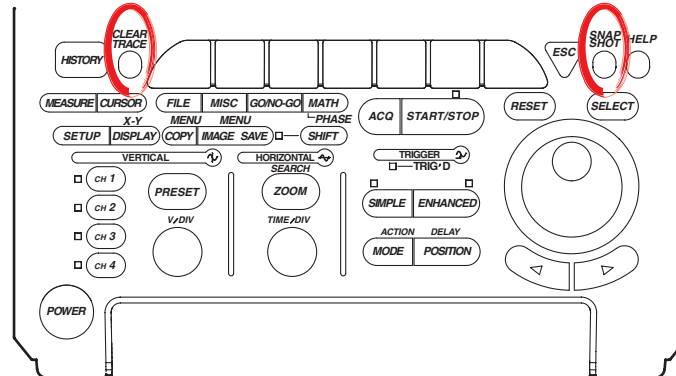

Operating Procedure

Snapshot

Press **SNAP SHOT**. The snapshot process will start.

Clear Trace

Press **CLEAR TRACE**. The clear trace process will start.

Explanation

Snapshot

This function retains the waveforms currently displayed on the screen. To activate this function, just press **SNAP SHOT** without stopping acquisition. The currently displayed waveform will be retained. Hence it is very useful when you want to compare waveforms.

The following operations are not available for snapshot waveforms.

- Cursor measurements and automatic measurements
- Zoom and math operations

The snapshot waveforms can be saved or loaded.

For details, see section 11.8, "Saving/Loading Snapshot Waveforms."

Clear Trace

This function clears every waveform currently displayed on the screen.

If the trace is cleared while waveform acquisition is in progress, it is restarted from the first trace.

The instrument is performing GO/NO-GO determination, action-on-trigger, or waveform search.

The **SNAP SHOT** and **CLEAR TRACE** are not Operative in the Following Cases.

- The instrument is in remote state, controlled via the communication interface.
- The instrument is performing an operation, for example, it is in the process of printing out or performing auto setup, determining GO/NO-GO, performing an action on trigger, or searching data.

4.7 Calibration

Relevant Keys

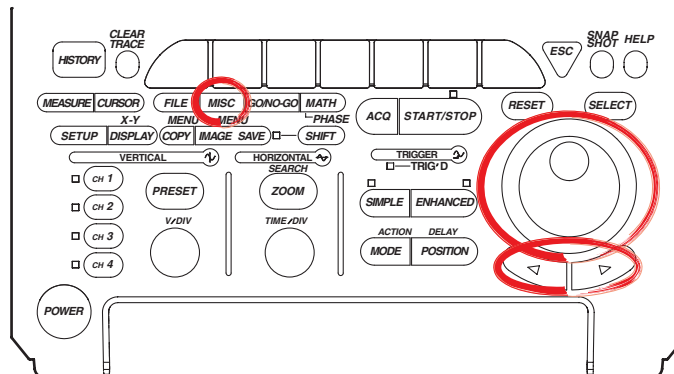

Operating Procedure

Performing Calibration

1. Press **MISC**. The MISC menu will appear.
2. Press the **Calibration** soft key.

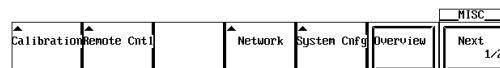

3. Press the **Auto Cal** soft key to select either ON or OFF.

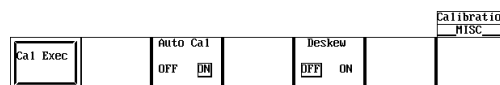

4. Press the **Deskew** soft key to select either ON or OFF.
5. If ON is selected in step 4, select the desired channel.
Pressing the **Target CH** soft key displays a menu used to select the channel.



6. Press the soft key corresponding to the desired channel to select the channel.

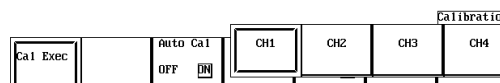

7. Turn the jog shuttle to set the Deskew Time.
8. Press the **Cal Exec** soft key to start calibration.



Explanation

Calibration

The following parameters can be calibrated. Perform calibration when highly accurate measurements are required.

- Ground level offset
- A/D converter gain
- Trigger threshold
- Time axis for repetitive sampling mode

Points for Attention

- Always allow the instrument to warm up for at least 30 minutes after the power is turned ON before starting calibration. If calibration is performed immediately after the power is turned ON, the calibration may be inaccurate due to drift caused by fluctuation in the temperature of the instrument.
- Calibration must be performed when the temperature of the instrument is stable and is between 5°C and 40°C (preferably at 23°C \pm 5°C).
- When performing calibration, remove the input signals. Otherwise, proper calibration may not result.

Note

- The above calibration is performed automatically when power is turned ON.
 - If the V/div knob has been turned, perform calibration for all parameters except the time axis for repetitive sampling mode.
-

Auto Calibration (Auto Cal)

Calibration is performed automatically after the times shown below elapse after turning ON the power, when the T/div setting is changed, or when waveform acquisition is started.

- After 3 minutes
- After 10 minutes
- After 30 minutes
- After one hour and every hour thereafter

If the DL1620/DL1640/DL1640L is auto-calibrated while input takes place, it is recommended that you disconnect the input and then repeat calibration.

Deskew

Corrects the CH1 to CH4 (or CH1 and CH2 for the DL1620) delays.

Deskew Time Setting Range

The correction time is set within the following range.

–100 ns to 100 ns

4.8 Using the Help Function

Relevant Keys

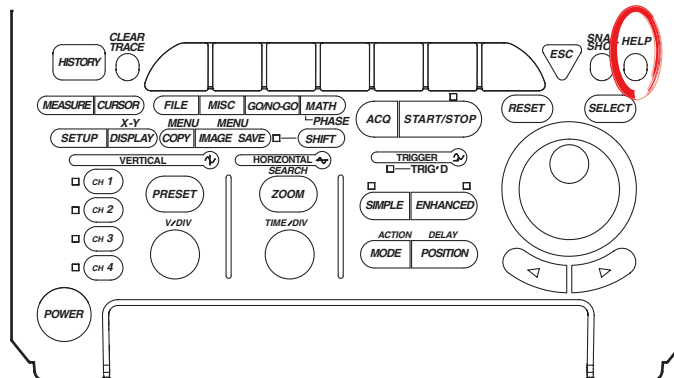

Operating Procedure

Displaying a Help Window

1. Press **HELP**.
2. Press the function key or soft key for which you want help.

Clearing the Help Window

3. Press **HELP** again to close the window.

Explanation

Displaying a Help Window

Pressing **HELP** displays the soft key menu which was in effect before **HELP** was pressed, or displays a help window which contains information related to jog shuttle menu settings.

If a key is pressed or the jog shuttle is turned while a help window is displayed, the help window relating to the displayed soft key menu or the jog shuttle menu will appear.

Clearing the Help Window

Pressing **HELP** again while a help window is displayed will clear the help window.

5.1 Turning Channels ON/OFF

Relevant Keys

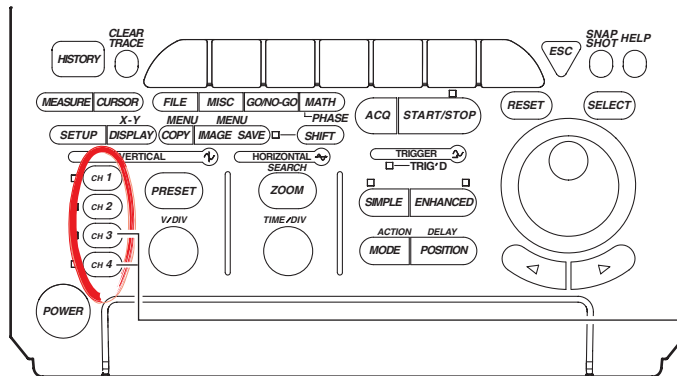

The DL1620 is not equipped with channels 3 and 4.

Operating Procedure

1. Press one of CH1 to CH4 (or **CH1** to **CH2** for the DL1620) to select the desired channel.
2. Press the Display soft key to select ON or OFF.
CH1 to CH4 (or **CH1** to **CH2** for the DL1620) can be pressed twice to turn the channels ON or OFF.

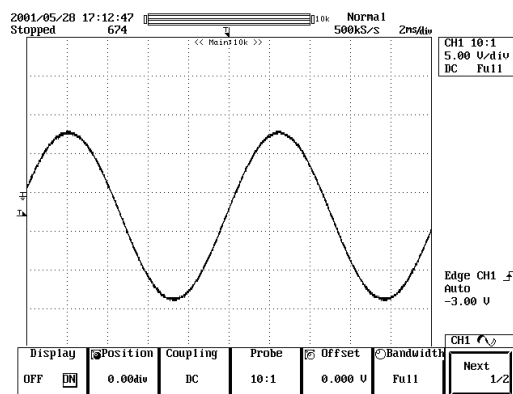

Explanation

The channels CH1 to CH4 (or CH1 to CH2 for the DL1620) can be displayed simultaneously.

When turned ON, the indicators to the left of the channel keys light.

Note

- The screen can be split into 1, 2, or 4 display areas (or 1 to 2 display areas). (See section 8.1) A scaling value and waveform label name for each display area (see sections 8.4, 8.5) can also be displayed.
- If a waveform or waveforms are loaded from history memory, floppy disk, Zip disk, or PC card the input waveform cannot be displayed. To compare waveforms, use the snapshot function.

5.2 Setting the Vertical Position of a Waveform

<For a description of this function, see page 1-5>

Relevant Keys

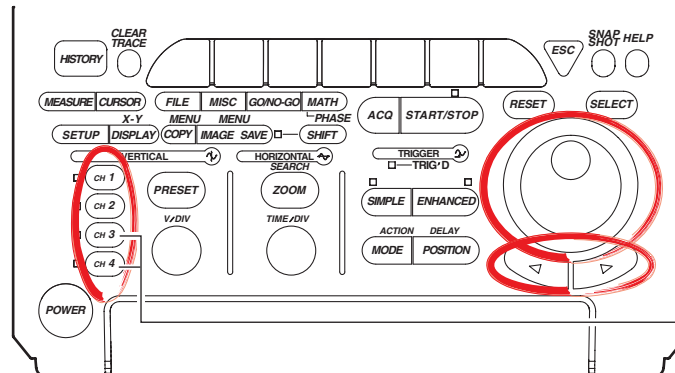

The DL1620 is not equipped with channels 3 and 4.

Operating Procedure

1. Press one of the keys from **CH1** to **CH4** (or **CH1** to **CH2** for the DL1620) to select the desired channel.
2. Press the **Position** soft key to set the jog shuttle action to Position.

Display	Position	Coupling	Probe	Offset	Bandwidth	CH1
OFF	IN	0.004V	DC	10:1	0.000 V	Full
						Next 1/2

3. Turn the jog shuttle to set the vertical position.
You can change the setting a digit using the arrow keys (located below the jog shuttle).

Explanation**Range of Movement**

The vertical position can be moved in the range between ± 4 div from the center position in the waveform display frame.

Setting Resolution

0.01 div

Confirming the Vertical Position

For input waveforms and computed waveforms, the ground level and vertical position are marked on the left of the waveform display frame.

500 mV/div, Offset: -1 V, Offset Cancel: OFF, Position: 0 div

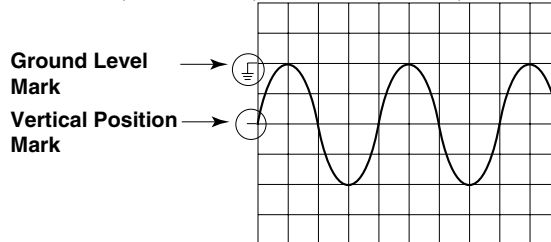
**Note**

- The data which go out of the waveform display frame from moving the vertical position are handled as overflow data.
- If the display waveform goes out of the waveform display frame from moving the vertical position during the waveform acquisition is starting, a chopped waveform is displayed as shown in the following figure even if the vertical position is returned to its original position after stopping the acquisition.

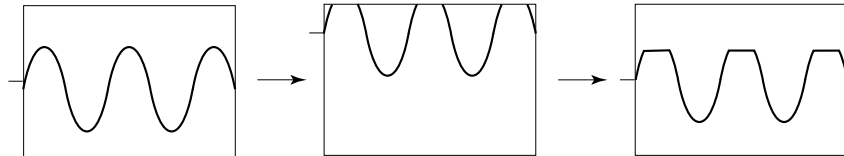

- If the vertical position is moved, the effective data range also changes. For details, see section 1.2.

5.3 Selecting Input Coupling

<For a description of this function, see page 1-6>

Relevant Keys

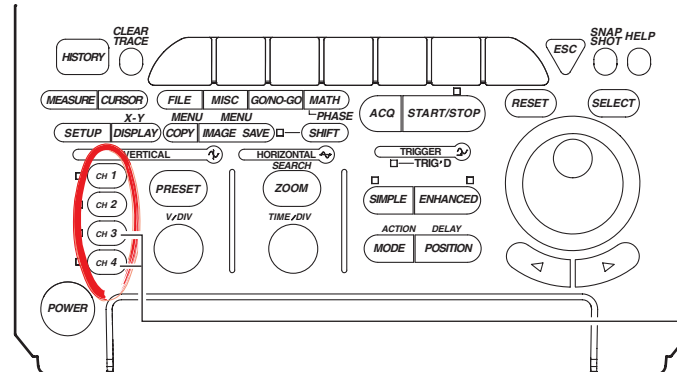

The DL1620 is not equipped with channels 3 and 4.

Operating Procedure

1. Press one of the keys from **CH1** to **CH4** (or **CH1** to **CH2** for the DL1620) to select the channel.
2. Press the **Coupling** soft key to display the menu used to select the coupling.

Display	Position	Coupling	Probe	Offset	Bandwidth	CH1
OFF	DN	0.00div	DC	10:1	0.000 U	Fu11
						Next 1/2

3. Press the soft key corresponding to the desired coupling.

Display	AC	DC	GND	Offset	Bandwidth	CH1
OFF	DN			0.000 U	Fu11	Next 1/2

Explanation**Input Coupling**

The following three types of input coupling are available.

- AC: Acquires and displays only the AC content of the input signal.
 DC: Acquires and displays both the DC and the AC content of the input signal (1 M Ω).
 GND: Checks the ground level.

Input Coupling and Frequency Characteristic

The frequency characteristic when AC or DC is selected is shown below.

Note that low-frequency signals and low-frequency contents are not acquired if AC is selected.

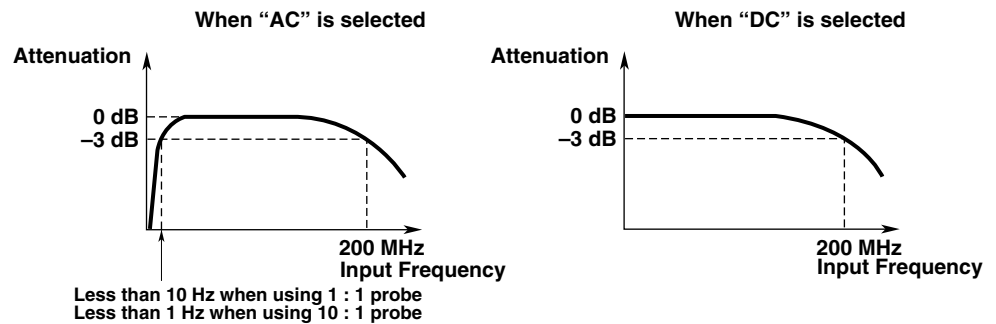
**CAUTION**

The maximum input voltage when the frequency is less than or equal to 1 kHz is 300 VDC or 300 V RMS. Applying a voltage that exceeds these values can damage the input section. When the frequency exceeds 1 kHz, voltages below these values can also sometimes damage the input section.

5.4 Selecting Probe Attenuation

<For a description of this function, see page 1-7>

Relevant Keys

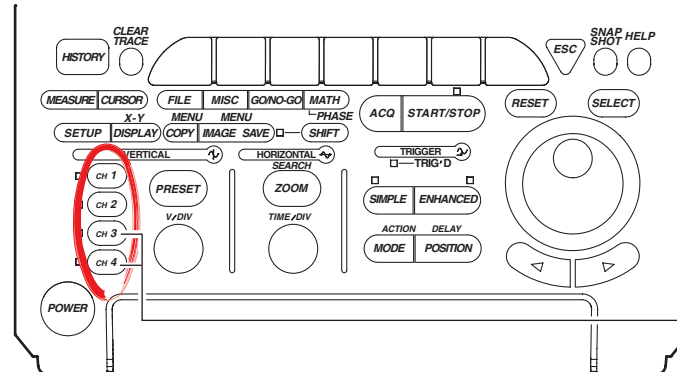

The DL1620 is not equipped with channels 3 and 4.

Operating Procedure

1. Press one of the keys from **CH1** to **CH4** (or **CH1** to **CH2** for the DL1620) to select the desired channel.
2. Press the **Probe** soft key to display the menu used to select the attenuation.

Display	Position	Coupling	Probe	Offset	Bandwidth	CHI
OFF	IN	0.004V	DC	10:1	0.000 V	Fu11
						Next 1/2

3. Press the soft key corresponding to the desired attenuation.

10A:1V (0.1V/A)	100A:1V (0.01V/A)	1:1	10:1	100:1	1000:1	CHI
			10:1			Next 1/2

Explanation

You can select the attenuation or the current-to-voltage conversion ratio of the probe of each channel according to the probe being used from the following.

Probe attenuation: 1:1, 10:1, 100:1, 1000:1

Probe current-to-voltage conversion ratio: 10A:1 V(0.1 V/A)*, 100A:1 V(0.01 V/A)*

* The output voltage of the supported current probe is indicated inside the parentheses.

Note

If the attenuation or the current-to-voltage conversion ratio is not set correctly, the voltage and scale values of the input signals will not be displayed correctly. For example, if you set the attenuation to 1:1 when you are actually using a 10:1 probe, the displayed value for the waveform amplitude will be 1/10th the actual value.

5.5 Setting the Offset Voltage

<For a description of this function, see page 1-6>

Relevant Keys

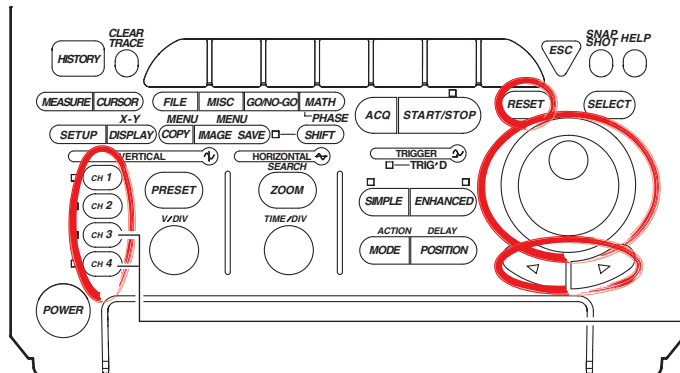

The DL1620 is not equipped with channels 3 and 4.

Operating Procedure

Setting the Offset Value

1. Press one of the keys from **CH1** to **CH4** (or **CH1** to **CH2** for the DL1620) to select the channel.
2. Press the **Offset** soft key.

Display	Position	Coupling	Probe	Offset	Bandwidth	CH1
OFF	IN	0.00div	DC	10:1	0.000 V	Fu11
						Next
						L/2

3. Turn the jog shuttle to set the offset value.
You can change the setting a digit using the arrow keys (located below the jog shuttle).

Resetting the Offset Value (Set to 0 V)

4. Press **RESET** to set the offset value to 0 V.

Explanation

The offset voltage setting applies to all input couplings (AC, DC, and GND couplings).

Offset Voltage Setting Range

Sensitivity Range (Probe = 1 : 1)	Offset Voltage Setting Range
2 mV/div to 50 mV/div	-1.0 V to 1.0 V
0.1 V/div to 0.5 V/div	-10.0 V to 10.0 V
1 V/div to 5 V/div	-100.0 V to 100.0 V
10 V/div	-50 V to 50 V

- The setting resolution is 0.01 div. If the voltage scale is 2 mV/div, for example, the setting resolution will be 0.02 mV.
- The values are 10 times, 100 times, and 1000 times the values shown above when the probe attenuation is 10:1, 100:1, and 1000:1, respectively. If the probe current-to-voltage conversion ratio is 10 A : 1 V, the values are the same 10 times the values shown above with the unit changed to A. If the ratio is 100 A : 1 V, the values are 100 times the values shown above with the unit changed to A.

Resetting the Offset Voltage

You can return the offset to 0V by pressing **RESET**.

Important Points

- Setting the offset voltage while acquisition is stopped will change the display position only. The newly set offset voltage will come into effect when acquisition is restarted.
- You can select whether or not the offset voltage is reflected in the results of cursor measurements, automatic measurements, or math computations. See section 14.4.
- If you change the probe attenuation, the offset changes proportionally to reflect the new attenuation rate.
- If you change the vertical axis sensitivity after setting the offset voltage value, the offset voltage value does not change.
- The selectable range and resolution of the offset voltage value vary depending on the vertical axis sensitivity setting.

The behavior when you change the vertical axis sensitivity after setting the offset voltage value is indicated below. If you change the vertical axis sensitivity back to the original setting without changing the offset voltage value, the original offset voltage value returns.

- When the vertical axis sensitivity is increased (the value is decreased) and the specified offset value exceeds the selectable range of the offset voltage at the new vertical axis sensitivity, the offset voltage is set to the maximum value of the selectable range of the offset value at the new vertical axis sensitivity.
- When the vertical axis sensitivity is decreased (the value is increased) and the specified resolution of the offset value falls below the resolution of the offset value at the new vertical axis sensitivity, the resolution is set to the resolution of the offset voltage at the new vertical axis sensitivity.

5.6 The Preset Function

Relevant Keys

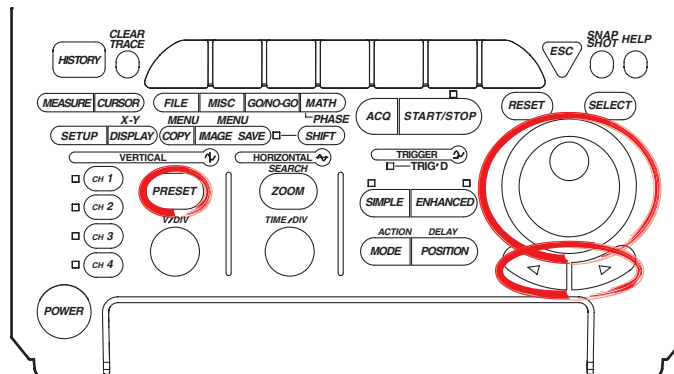

Operating Procedure

Selecting the Channel

1. Press **PRESET**.
2. Press the **Select** soft key to display the channel menu.

Select	Type	Probe				PRESET
All	CMOS(5V)	10:1				Exec

3. Press the soft key corresponding to the desired channel. Pressing All will select all the channels.

Select	Type	Probe				PRESET
All	CH1	CH2	CH3	CH4		Exec

Selecting the Probe Attenuation

4. Press the **Probe** soft key to display a menu used to select the attenuation.

Select	Type	Probe				PRESET
All	CMOS(5V)	10:1				Exec

5. Press the soft key corresponding to the desired attenuation.

Select	Type	Probe				PRESET
10A:1V (0.1U/A)	100A:1V (0.01U/A)	1:1	10:1	100:1	1000:1	Exec

Selecting the Preset Type

6. Press the **Type** soft key to display the preset type selection menu.

Select	Type	Probe				PRESET
All	CMOS(5V)	10:1				Exec

7. Set the type by pressing the soft key corresponding to **CMOS (5 V)**, **CMOS (3.3 V)**, or **User**.

Select	Type	Probe				PRESET
All	CMOS(5V)	CMOS(3.3V)	User			Exec

5.6 The Preset Function

Setting the V/div, Offset Voltage, and Trigger Level (When the Preset Type is User)

8. Press the **Type** soft key to display the preset type selection menu.

Select	Type	Probe				PRESET
All	CMOS(5V)	10:1				Exec

Press the **User** soft key.

Select	CMOS(5V)	CMOS(3.3V)	User				PRESET
All							Exec

9. Press the **V/div** soft key to highlight the jog shuttle icon.
 10. Turn the jog shuttle to set the V/div value.

Select	Type	Probe	V/div	Offset	Trig Lvl	PRESET
All	User	10:1	50.0 V	0.0 V	0.0 V	Exec

11. Press the **Offset** soft key to select Offset, then turn the jog shuttle to set the Offset value.

Select	Type	Probe	V/div	Offset	Trig Lvl	PRESET
All	User	10:1	50.0 V	0.0 V	0.0 V	Exec

12. In a similar fashion, set the Trig Lvl.
 You can change the setting a digit using the arrow keys (located below the jog shuttle).

Executing the Preset

13. Press the **Exec** soft key to execute the preset.

Select	Type	Probe	V/div	Offset	Trig Lvl	PRESET
All	User	10:1	50.0 V	0.0 V	0.0 V	Exec

Explanation

The preset function automatically sets each key setting, such as the V/div, input coupling and trigger level, to the optimum value for measurement of 5-V or 3.3-V CMOS signals (or to an arbitrary value). Also, you can automatically set the appropriate values for use with the current probe* (sold separately). This function allows you to make settings for a selected channel or for all channels at the same time.

* Current probes made by YOKOGAWA: 700937, 701930, 701931, 701932, and 701933

Settings Made by a Preset

	CMOS (5 V)	CMOS (3.3 V)	User
Input Coupling	DC	DC	DC
Trigger Coupling	DC	DC	DC
Probe	1:1, 10:1, 100:1, 1000:1, 10 A:1 V (0.1V/A), or 100 A:1 V (0.01V/A) are available.		
V/div	2 V/div ^{*1}	1 V/div ^{*1}	Arbitrary ^{*2}
Offset Voltage	0 V	0 V	Arbitrary ^{*2}
Trigger Level	2.5 V	1.65 V	Arbitrary ^{*2}

^{*1} 2 V/div when probe setting is 1000 : 1.

^{*2} For details about the setting ranges, see Sections 5.5, 5.8, and 6.5.

5.7 Setting the Bandwidth

<For a description of this function, see page 1-7>

Relevant Keys

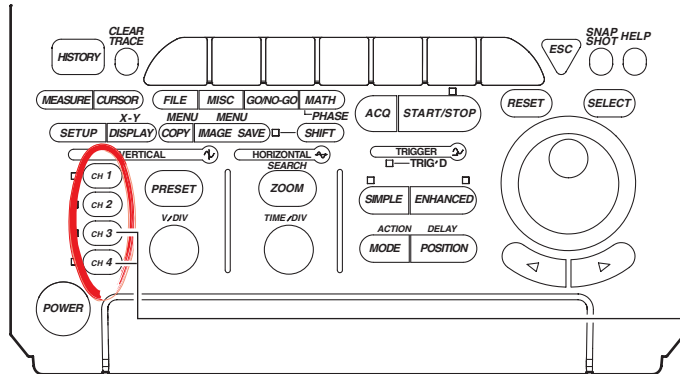

The DL1620 is not equipped with channels 3 and 4.

Operating Procedure

1. Press one of the keys from **CH1** to **CH4** (or **CH1** to **CH2** for the DL1620) to select the channel.
2. Press the **Bandwidth** soft key to set the jog shuttle target as the bandwidth.

Display	Position	Coupling	Probe	Offset	Bandwidth	CH1
OFF	DN	0.00div	DC	10:1	0.000 V	Full
						Next
						1/2

3. Turn the jog shuttle and set the bandwidth value.

Display	Position	Coupling	Probe	Offset	Bandwidth	CH4
OFF	DN	0.00div	DC	10:1	0.000 V	80kHz
						Next
						1/2

4. Repeat steps 1 to 3 as necessary to set other channels.

Note

The bandwidth is set for each channel. Set the bandwidth on all necessary channels.

Explanation

Use this function to remove specific frequency components from the input signal. The bandwidth is set for each channel.

Bandwidth

The following frequency bandwidths are available: 10 kHz, 20 kHz, 40 kHz, 80 kHz, 160 kHz, 320 kHz, 640 kHz, 1.28 MHz, 20 MHz. The following figure shows how the bandwidth affects the frequency characteristics. When Full is selected, the bandwidth is max. 200 MHz.

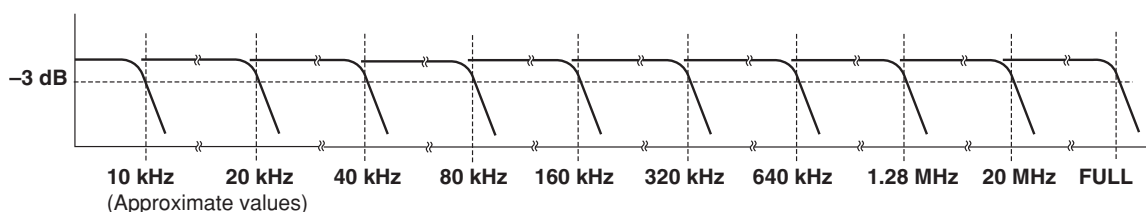

5.8 Setting V/div

<For a description of this function, see page 1-5>

Relevant Keys

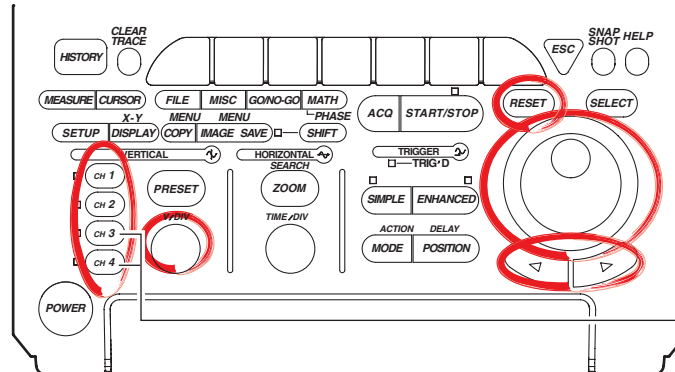

The DL1620 is not equipped with channels 3 and 4.

Operating Procedure

Setting the V/div Using the V/div Knob

1. Press one of the keys from **CH1** to **CH4** (or **CH1** to **CH2** for the DL1620) to select the channel.
2. Turn the **V/DIV** knob to set the V/div value.

Note

- Changing the **V/DIV** setting while the waveform acquisition is stopped will not change the displayed waveform. The new **V/div** value takes effect the next time waveform acquisition is started.
- When the waveform acquisition is stopped, the cursor measurement value and automated measurement of waveform parameters will show values using the old **V/div** setting even if the **V/DIV** knob is turned.

Setting the V/div Using the Variable Parameter

1. Press one of the keys from **CH1** to **CH4** (or **CH1** to **CH2** for the DL1620) to select the channel.
2. Press the **Next 1/2** soft key.

Display	Position	Coupling	Probe	Offset	Bandwidth	CH1
OFF	IN	0.004i	DC	10:1	0.000 U	Fu11
						Next 1/2

3. Press the **Variable** soft key.

Invert	Variable	Linear Sci	Label	CH1
OFF	ON	0.100 U	OFF	ON
				CH1
				Next 2/2

4. Turn the jog shuttle to set the **V/div** value.
You can change the setting a digit using the arrow keys (located below the jog shuttle).

Note

- If the **V/div** setting is changed by rotating the **V/DIV** knob, the **Variable** value is set to the modified **V/div** value.
- If **Variable** is reset with **RESET**, the **V/div** setting returns to the value set with the **V/div** knob before setting **Variable**.

Explanation

The V/div (voltage axis sensitivity) setting is used to adjust the amplitude of the displayed waveform so that the waveform can be observed easily. The V/div setting is made by setting the voltage value per division on the screen grid. There are two methods available in setting the V/div.

Setting the V/div Using the V/div Knob

The settings are “1 V/div,” “2 V/div,” “5 V/div,” and their tenfold multiples.

This setting will become the reference for the range that can be set using the Variable parameter (described next) and the resolution.

- **V/div Setting Range**

The V/div setting range for each probe attenuation value is shown in the table below.

Probe Attenuation	Setting Range
1 : 1	2 mV/div to 10 V/div
10 : 1	20 mV/div to 0.1 kV/div
100 : 1	0.2 V/div to 1 kV/div
1000 : 1	2 V/div to 10 kV/div
10 A : 1 V	20 mA/div to 100 A/div
100 A : 1 V	0.2 mA/div to 1 kA/div

Setting the V/div Using the Variable Parameter in the CH Menu

You can set the V/div using a resolution that is finer than the resolution provided by the V/div knob and vertically expand or reduce the displayed waveform.

The waveform acquisition can be started with the changed V/div setting.

- **Range**

The following table shows the range when the probe attenuation setting is 10 : 1.

V/div Setting with V/div Knob	Setting Range of Variable	Setting Resolution
20 mV/div	2.0 mV to 50.0 mV	0.2 mV
50 mV/div	5.0 mV to 100.0 mV	0.5 mV
100 mV/div	10 mV to 200 mV	1 mV
200 mV/div	20 mV to 500 mV	2 mV
500 mV/div	50 mV to 1000 mV	5 mV
1 V/div	0.10 V to 2.00 V	0.01 V
2 V/div	0.20 V to 5.00 V	0.02 V
5 V/div	0.50 V to 10.00 V	0.05 V
10 V/div	1.0 V to 20.0 V	0.1 V
20 V/div	2.0 V to 50.0 V	0.2 V
50 V/div	5.0 V to 100.0 V	0.5 V
100 V/div	10 V to 200 V	1 V

- The values are 1/10th, 10 times, and 100 times the values shown above if the probe attenuation is 1:1, 100:1, and 1000:1, respectively.
- If the probe current-to-voltage conversion ratio is 10 A: 1 V (0.01 V/A), the values are the same values shown above with the unit changed to A. If the ratio is 100 A: 1 V (0.01 V/A), the values are ten times the values shown above with the unit changed to A.

5.9 Displaying Inverted Waveforms

<For a description of this function, see page 1-4>

Relevant Keys

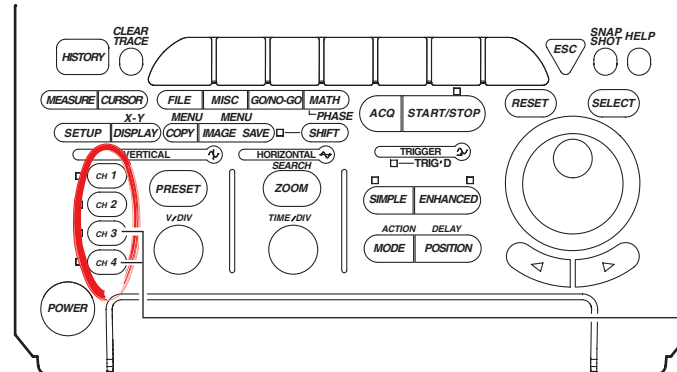

The DL1620 is not equipped with channels 3 and 4.

Operating Procedure

1. Press one of the keys from **CH1** to **CH4** (or **CH1** to **CH2** for the DL1620) to select the channel.
2. Press the **Next 1/2** soft key.

						CH1
Display	Position	Coupling	Probe	Offset	Bandwidth	Next 1/2
OFF	IN	0.004i	DC	10:1	0.000 U	Fu11

3. Press the **Invert** soft key to select ON or OFF.

					CH1
Invert	Variable	Linear Sci	AX+B	Label	Next 2/2
OFF	ON	0.100 U	OFF	ON	CH1

Note

The inverted waveform display must be set for each channel. Make appropriate settings for all the necessary channels.

Explanation

The waveform is inverted vertically across the center. This setting is made for each channel.

Trigger

Even when the waveform is inverted, the trigger is activated by the non-inverted waveform.

Cursor Measurement, Automated Measurement of Waveform Parameters, and Computations

Cursor measurements, automated measurements of waveform parameters, and computations are performed for the non-inverted waveform.

5.10 Using the Linear Scaling Function

<For a description of this function, see page 1-21>

Relevant Keys

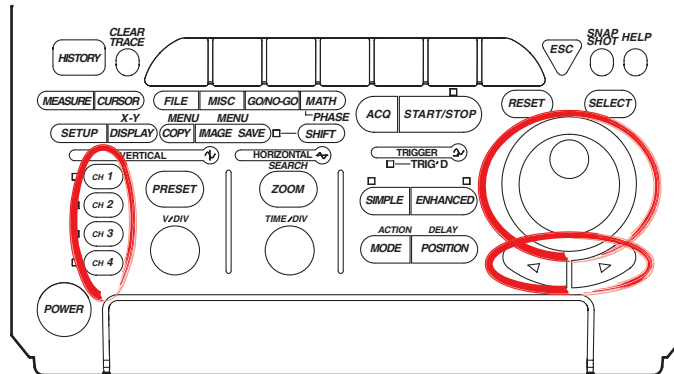

Operating Procedure

1. Press one of the keys from **CH1** to **CH4** (or **CH1** to **CH2** for the DL1620) to select the channel.
2. Press the **Next 1/2** soft key.

Display	Position	Coupling	Probe	Offset	Bandwidth	CH1
OFF	IN	0.00div	DC	10:1	0.000 V	Full
						Next
						1/2

3. Press the **Linear Sci AX+B** soft key to select ON.

Invert	Variable	Linear Sci	AX+B	Label	CH1
OFF	ON	0.100 U	OFF	ON	CH1
					Next
					2/2

4. Press the **A/B** soft key.

Invert	Variable	Linear Sci	AX+B	Unit	Label	CH1
OFF	ON	0.100 U	OFF	IN	CH1	Next
					2/2	

5. Turn the jog shuttle to set the value of A.
You can use the arrow keys to move between the digits.
6. In a similar fashion, set the value B.
7. If necessary, press the **Unit** soft key to display the keyboard and enter the unit.

Note

- Linear scaling is not available for the following waveforms.
Snapshot waveforms
Accumulated waveforms (except for newest waveform)
- You can set linear scaling separately for each channel.
- The A and B values remain in memory after you switch the linear scaling function OFF, and are restored if you switch the function back on.
- Mathematical computations operate with respect to the scaling results.

5.10 Using the Linear Scaling Function

Explanation

This function lets you apply linear scaling to the measurement values. If you set this feature ON, the screen displays the scaled results rather than the original measurements. The scaling relationship is

$$Y = AX + B$$

where X is the measurement value and Y is the scaled value. Note that you can select the dimensional unit for the scaled display.

Scaling Coefficient (A) and Offset (B)

Range for A, B: $-9.9999E+30$ to $+9.9999E+30$

Default A: $1.0000E+00$

 B: $0.0000E+00$

Dimensional Unit

Unit identifier (alphanumeric string) of up to four characters.

Displaying the Scale Value

The linearly scaled values of the upper and lower limits of the vertical axis of each channel can be displayed. (See section 8.4, "Turning ON/OFF the Scale Value Display.")

5.11 Selecting the Timebase

<For a description of this function, see page 1-3>

Relevant Keys

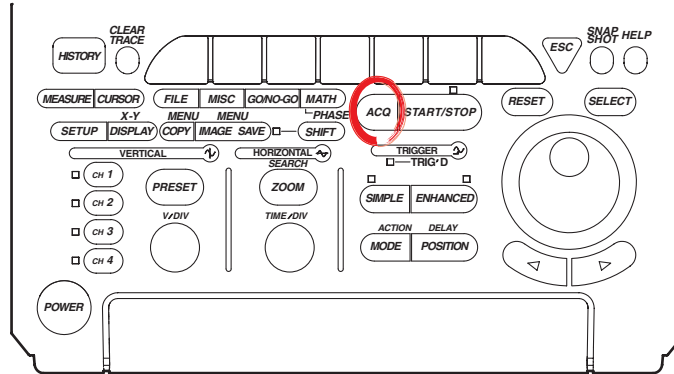

Operating Procedure

1. Press **ACQ**.
2. Press the **Time Base** soft key to select Int or Ext.

Record Length	Mode	Count	Hireso Mode	Repetitive	ACQ Time Base
10k	Normal	Infinite	OFF	ON	Int Ext

Threshold Setting (If EXT Clock)

3. If you have selected use of an external clock, you must now set the threshold level. This setting is identical to the trigger-level setting; see Section 6.5, "Setting the Edge Trigger (SIMPLE)" for the procedure. Note that you must set the trigger source to EXT before setting the level.

Explanation

Selectable Timebases

Timebase can be selected from the following three types.

- INT Internal clock signal
- EXT IN Clock signal input to the EXT TRIG IN/EXT CLOCK IN/TRIG GATE IN terminal

When EXT IN is Selected

Input a clock signal to the EXT CLOCK IN/EXT TRIG IN/TRIG GATE IN terminal on the rear panel. The clock signal must conform to the specifications given below.

Item	Specifications
Connector Type	BNC
Maximum Permissible Input Voltage	± 40 V (DC + ACpeak) or 28 Vrms, 10 kHz or less
Frequency Range	40 Hz to 5 MHz (continuous clock only)
Minimum Input Level	0.3V _{P-P} (for the DL1640/DL1640L) 0.1V _{P-P} (for the DL1620 with the ± 1 V range selected) 1V _{P-P} (for the DL1620 with the ± 10 V range selected)
Input Impedance	Approx. 1 M Ω and 28 pF
Threshold Level	± 2 V in 5 mv resolution (for the DL1640/DL1640L) ± 1 V in 5 mv resolution (for the DL1620 with the ± 1 V range selected) ± 10 V in 50 mv resolution (for the DL1620 with the ± 10 V range selected)
Sampling Jitter	± 10 ns or less
Minimum Pulse Width	10 ns or more for both High and Low levels

[Input Terminal]
DL1640/DL1640L
Rear Panel
EXT CLOCK IN
EXT TRIG IN
 ≤ 40 Vpk 1M Ω



DL1620
Front Panel

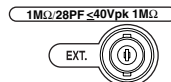

CAUTION

If a clock signal exceeding the above maximum permissible input voltage is input to the EXT TRIG IN/EXT CLOCK IN terminal, damage to the internal circuits of the instrument may result.

When Sampling Using an External Clock

- The clock signal must be continuous. No burst signal is allowed.
- Only real-time sampling mode is available.
- Even if you set the acquisition mode to envelope mode, the sampling is performed in normal mode.
- Display of waveforms is not possible in roll mode.
- No function to divide the clock signal is available.
- Since the time axis setting cannot be changed, expand the time axis if you want to change the display range. For a description of expanding waveforms, see section 8.9.
- The trigger delay cannot be set.
- The deskew function cannot be used.
- The time measured by the cursor measurement or automated measurement function is expressed in the number of pulses of the clock signal. No unit is displayed.

5.12 Setting T/div

<For a description of this function, see page 1-6>

Relevant Keys

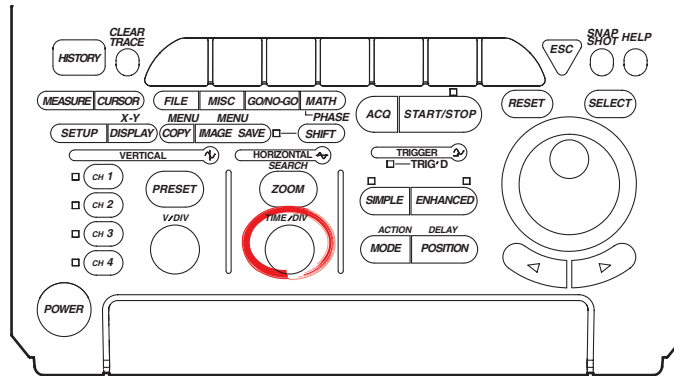

Operating Procedure

1. Turn the TIME/DIV knob to set the desired T/div.

Note

- Turning the TIME/DIV knob while acquisition is stopped displays the new T/div value in parentheses on the upper right of the screen. The new setting will come into effect the next time the acquisition is started.
- When repetitive sampling mode is OFF (see section 7.6), the maximum sampling rate is 200 MS/s (or 100 MS/s when the high-resolution mode is ON).
- Even when the repetitive sampling is turned OFF, there are cases in which the mode automatically changes to the repetitive sampling mode when the T/div is changed. For the relationship between the T/div setting and the sample rate, see Appendix 1, "Relationship between the Time Axis Setting, Sample Rate, and Record length."

Explanation

The T/div setting is made by setting the time per division on the screen grid.

Setting Range

For a record length of 1 kWord:	2 ns/div–5 s/div
For a record length of 10 kWord:	2 ns/div–50 s/div
For a record length of 100 k, 1 M, or 10 MWord: (10 MWord for 1640L only)	2 ns/div–500 s/div
For a record length of 32 MWord on the DL1640L: (or 2 ns/div–800 s/div when in high resolution mode)	2 ns/div–640 s/div
For a record length of 8 MWord on the DL1620/DL1640:	2 ns/div–800 s/div
For a record length of 4 MWord on the DL1640L:	2 ns/div–800 s/div

T/div and Sampling Mode

Use of repetitive sampling mode lets you get the sample rate of 200 MS/s and above (or 100 MS/s and above if the high-resolution mode is ON). But note that the allowable time-scale settings vary according to record length. For details, see Appendix 1.

5.12 Setting T/div

T/div and Roll Mode

When acquisition count is infinite, acquisition mode is not average, or the trigger mode is auto, auto level, or single, roll mode display is enabled at the following T/div settings.

Model	Record Length	T/div
DL1620/	1 kwords	50 ms/div to 5 s/div
DL1640	10 kwords	50 ms/div to 50 s/div
	100 kwords to 1 Mwords	50 ms/div to 500 s/div
	8 Mwords	200 ms/div to 800 s/div
DL1640L	1 kwords	50 ms/div to 5 s/div
	10 kwords	50 ms/div to 50 s/div
	100 kwords to 1 Mwords	50 ms/div to 500 s/div
	4 Mwords	100 ms/div to 800 s/div
	10 Mwords	500 ms/div to 500 s/div
	32 Mwords	1 s/div to 640 s/div(500 ms/div to 800 s/div)

Ranges in parentheses () take effect in high resolution mode.

6.1 Setting the Trigger Mode

<For a description of this function, see page 1-11>

Relevant Keys

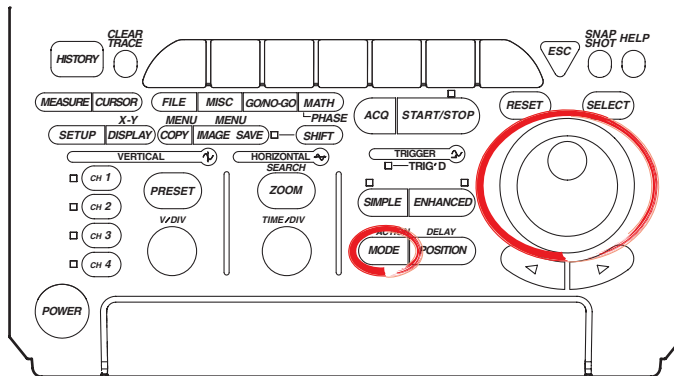

Operating Procedure

1. Press **MODE**.
2. Press the soft key corresponding to the desired mode to set the trigger mode.

Auto	Auto Level	Normal	Single	Single(N)	MODE	ACQ Count
						Infinite

3. Turn the jog shuttle to set the number of times to acquire the waveform.

Auto	Auto Level	Normal	Single	Single(N)	MODE	Single(N) Count
						2

Explanation

Auto Mode

If the trigger condition is met within the 100-ms timeout period, the waveform is updated on each trigger occurrence. If the trigger condition is not met after the timeout period elapses, the waveform is automatically updated. If the time axis setting is in the range in which the display mode is set to roll mode, the display is set to roll mode.

Auto Level Mode

If a trigger occurs within the timeout period, the waveform is displayed in the same fashion as in the auto mode. If a trigger does not occur within the timeout period, the center value of the amplitude of the trigger source is detected, the trigger level is automatically changed to the center value, and the trigger is generated to update the displayed waveform. The auto-level mode is valid only if the trigger is a simple trigger and the trigger source is CH1 to CH4 (or CH1 to CH2 for the DL1620). For all other cases, the operation is the same as the auto mode.

If the time axis setting is in the range in which the display mode is set to roll mode, the display is set to roll mode.

Normal Mode

The display is updated only when the trigger conditions are met. The display will not be updated if no trigger is caused. Therefore, to check the waveform or ground level when no trigger is detected, use auto mode.

6.1 Setting the Trigger Mode

Single Mode

The display is updated once when the trigger conditions are met and the waveform acquisition stops.

In the time axis setting range in which the display mode is set to roll mode, the display is set to roll mode. When a trigger occurs, the specified record length of data is acquired and the displayed waveform stops.

Single (N) Mode

The display is updated according to the number of times specified when the trigger conditions are met and the waveform acquisition stops. This mode is used when acquiring a waveform using the sequential store function. If the repetitive mode turn ON, this mode is automatically changed to single mode.

Note

The trigger mode setting applies to both simple and enhanced triggers.

6.2 Setting the Trigger Delay

<For a description of this function, see page 1-13>

Relevant Keys

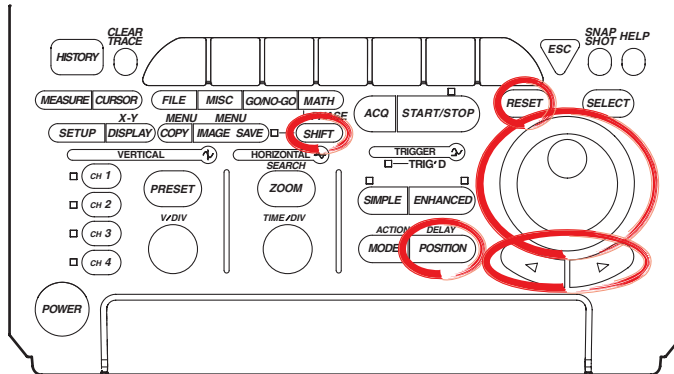

Operating Procedure

1. Press **SHIFT** to set the keys in the shifted condition. Functions marked in purple on the panel become active.
2. Press **POSITION**.
3. Units, ms, us, ns, and ps are displayed on the screen. Press the soft key corresponding to the desired unit. Turn the jog shuttle to set the trigger delay. You can move between the digits using the arrow keys. Pressing **RESET** resets delay to 0 s.

				DELAY	
ms	us	ns	ps		Delay
0	0	0	0		0.00us

You can set the trigger delay by pressing the **Delay** soft key and turning the jog shuttle.

Explanation

Although the display usually shows the waveform before and after the trigger point, using the delay function, it is possible to display the acquired waveform after a fixed time period elapses.

Setting Range for Trigger Delay

0 to 4 s (Resolution is $1 \div$ sample rate)

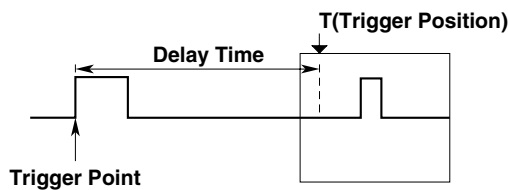

Points for Attention

- When T/div is changed, the trigger delay remains unchanged. However, its position in relation to the overall record length changes.
- If the timebase is provided by an external clock, the trigger delay is fixed at 0s (no delay).

6.3 Setting the Trigger Position

<For a description of this function, see page 1-13>

Relevant Keys

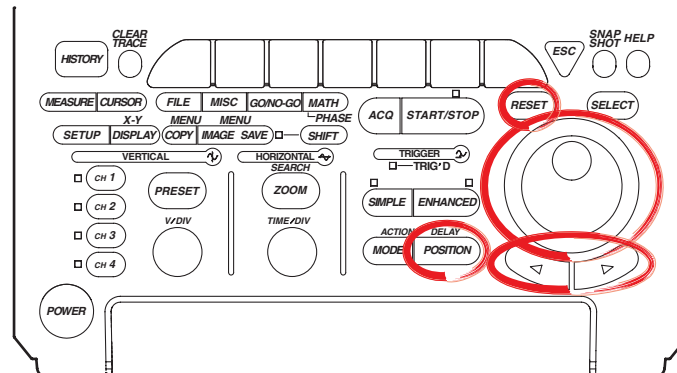

Operating Procedure

1. Press **POSITION**.
2. Turn the jog shuttle to set the trigger position.
You can use the arrow keys to move between the digits.
If you wish to select 10%, 50%, or 90%, you can press the corresponding soft key.

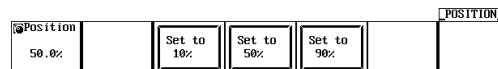

In addition, pressing **RESET**, resets the position to 50%.

Explanation

Trigger Position

The trigger position is the waveform position that results when the trigger delay is added to the trigger point. If the trigger delay is 0 s, therefore, the trigger position is equivalent to the trigger point. You can select the location of the trigger position on the screen.

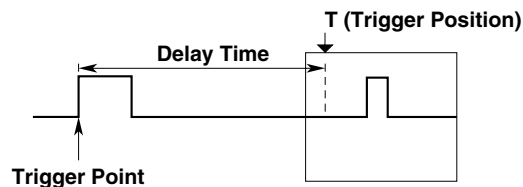

Setting Range for Trigger Position

0 to 100% of record length, in 1% steps

Position Marker

A position marker (marker) appears above the bar at the top of the screen. The marker indicates the trigger position with respect to the total record length.

When Setting the Trigger Position

- If you change the trigger position while waveform acquisition is suspended, the new setting will not become effective until acquisition is resumed and the waveform is updated.
- Note that cursor time measurements are with respect to the trigger position. Changing the trigger position therefore changes the measurement values (except during roll-mode display).
- When you change the T/div setting, the time axis setting is rescaled with respect to the trigger position.

6.4 Setting the Hold Off Time

<For a description of this function, see page 1-12>

Relevant Keys

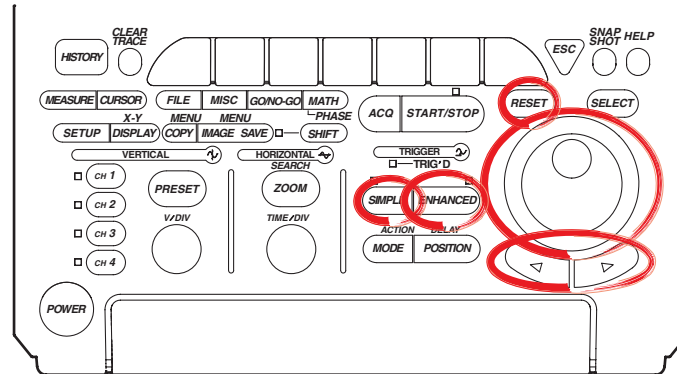

Operating Procedure

During Simple Trigger

1. Press **SIMPLE**.
2. If the jog shuttle control is not set to Hold Off, press the **Hold Off** soft key.

Source	Level	Slope	Coupling	HF Reject	Hysteresis	SIMPLE Hold Off (μs)
CH1	0.000 U	f1 f1	AC	BPF ON	z/z	0.00

3. Turn the jog shuttle to set the hold off period.
You can use the arrow keys to move between the digits. In addition, pressing **RESET**, resets the value to 0.08 μs (0.08 μs.)

Source	Level	Slope	Coupling	HF Reject	Hysteresis	SIMPLE Hold Off (μs)
CH1	0.000 U	f1 f1	AC	BPF ON	z/z	0.00

During Enhanced Trigger

1. Press **ENHANCED**.
2. If the jog shuttle control is not set to Hold Off, press the **Hold Off** soft key.

Type	Set Pattern	Level/ Coupling	Count	ENHANCED Hold Off (μs)
A → B(N)			1	0.00

3. Turn the jog shuttle to set the hold off period.
You can use the arrow keys to move between the digits. In addition, pressing **RESET**, resets the value to 0.08 μs (0.08 μs.)

Type	Set Pattern	Level/ Coupling	Count	SIMPLE Hold Off (μs)
A → B(N)			1	0.00

Note

The hold off time setting applies to simple trigger and enhanced trigger.

Explanation

This function prevents a trigger from being activated for a specified time, even if the trigger conditions are met during this time. The following two methods can be used to prevent the trigger. This is useful when you wish to activate the trigger in sync with a signal that is periodic as shown in the figure below.

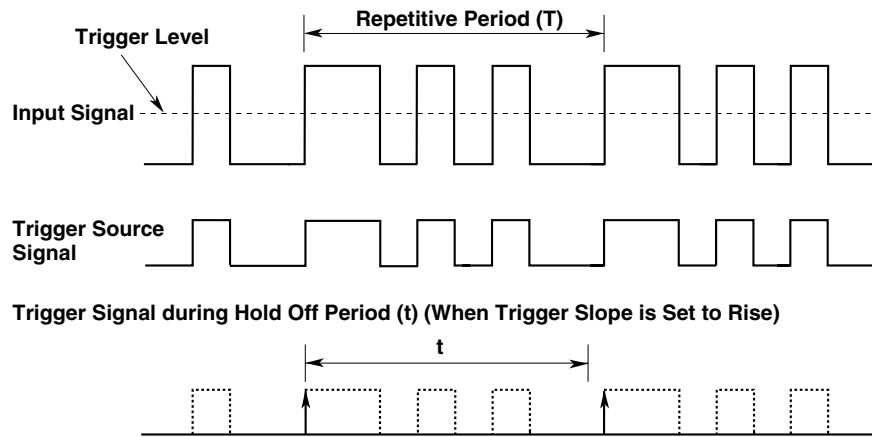

Hold Off Time Setting Range

80 ns to 10 s (default: 80 ns).

The setting resolution is 20 ns.

Points for Attention

- Updating of the waveform may be slow in repetitive sampling mode. In this case set the hold off time to a smaller value.
- If holdoff time is set to 100 ms or above, the trigger mode should be set to *normal*.
- When used with the A→B(N) or A Delay B trigger, the holdoff time operates with respect to condition A only.

6.5 Setting the Edge Trigger (SIMPLE)

<For a description of this function, see page 1-8>

Relevant Keys

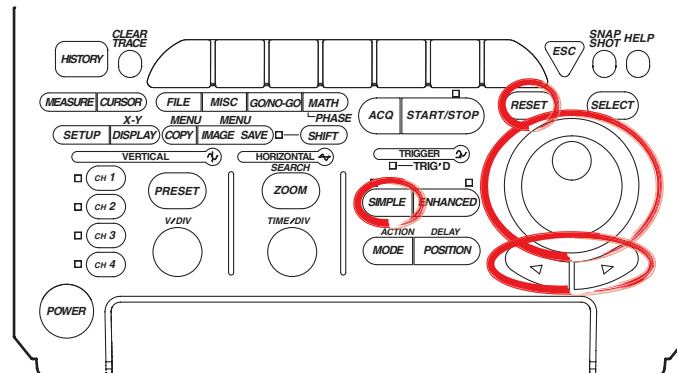

Operating Procedure

Setting the Trigger Source

1. Press **SIMPLE**.
2. Press the **Source** soft key to display the trigger source menu.

Source	Level	Slope	Coupling	HF Reject	Hysteresis	SIMPLE
CH1	0.000 U	f	DC	OFF	ON	Hold Off (uS) 0.00

3. Press the soft key corresponding to the channel to be set as the trigger source. (Ch3 and CH4 are not displayed on the DL1620.)

CH1	CH2	CH3	CH4	Ext	Line	SIMPLE
CH1						Hold Off (uS) 0.00

Setting the Trigger Level

4. If the jog shuttle control is not set to Level, press the **Level** soft key.

Source	Level	Slope	Coupling	HF Reject	Hysteresis	SIMPLE
CH1	0.000 U	f	DC	OFF	ON	Hold Off (uS) 0.00

5. Turn the jog shuttle to set the trigger level.
You can use the arrow keys to move between the digits. In addition, pressing **RESET** resets the trigger level to the current offset voltage value.

Note

The trigger level setting applies to simple trigger and enhanced trigger.

Setting the Trigger Slope

6. Press the **Slope** soft key to select f, \downarrow , or \uparrow .

Setting the Trigger Coupling

7. Press the **Coupling** soft key to select DC or AC.

Note

The trigger coupling setting applies to simple trigger and enhanced trigger.

Setting the HF Rejection ON or OFF

8. Press the **HF Reject** soft key to the desired frequency to set HF rejection ON or OFF.

Source	Level	Slope	Coupling	HF Reject	Hysteresis	Hold Off (uS)
CH1	0.000 U	f	DC AC	OFF ON	0.00 0.01	0.00

Setting the Hysteresis

9. Press the **Hysteresis** soft key to select \overline{A} or \overline{V} .

Setting the Hold Off

10. Set the hold off time according to the procedures given in 6.4, "Setting the Hold Off Time."

Explanation

An edge trigger is generated when the trigger source signal crosses a specified level.

Selecting the Trigger Source

Select from the following list of choices.

- CH1 to CH4 (or CH1 to CH2 for the DL1620)
- Ext (EXT TRIG IN terminal on the rear panel (or EXT. terminal on the front panel of the DL1620), see section 6.6, "Setting the External Trigger (SIMPLE)")
- Line (power signal, see section 6.7, "Generating Trigger on the Power Signal (SIMPLE)")

Setting the Trigger Level

Range: 8 div within the screen

Resolution: 0.01 div

For example, the resolution is 0.02 mV when the V/DIV setting is 2 mV/div.

You can also reset the trigger level to the current offset voltage with one key operation.

Setting the Trigger Slope

Select the trigger activation method relative to changes in trigger source level from the following three choices.

- f : Activated when the trigger source changes from below the trigger level to above the trigger level (rising).
- \overline{f} : Activated when the trigger source changes from above the trigger level to below the trigger level (falling).
- f \overline{f} : Activated on either a rising edge or falling edge.

Setting the Trigger Coupling

Select from the following list of choices.

- AC: Uses a signal that is obtained by removing the DC component from the trigger source signal.
- DC: Uses the trigger source signal as the trigger signal.

Setting the HF Rejection

Set ON when you wish to use a signal source obtained by removing the high-frequency components from the trigger signal as the trigger source.

6.5 Setting the Edge Trigger (SIMPLE)

Setting the Hysteresis

Sets a width to the trigger level so that the trigger is not activated by small changes in the trigger signal.

$\overline{\Delta}$: Approx. 0.3 div* of hysteresis around the trigger level.

$\underline{\Delta}$: Approx. 1 div* of hysteresis around the trigger level.

*: The values above are estimated values. They are not strictly guaranteed.

Setting the Hold Off

See section 6.4, "Setting the Hold Off Time."

6.6 Setting the External Trigger (SIMPLE)

Relevant Keys

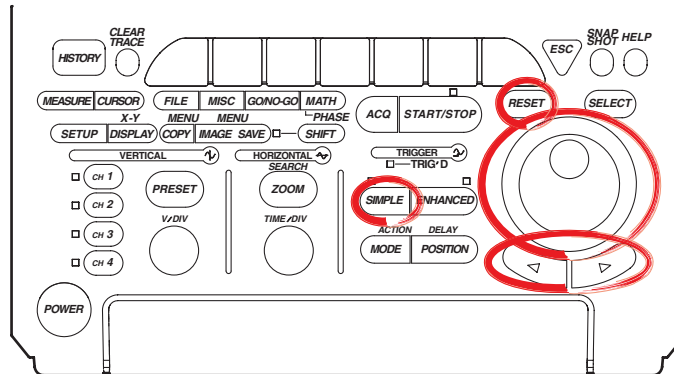

Operating Procedure

Setting the Trigger Source

1. Press **SIMPLE**.
2. Pressing the **Source** soft key to display the trigger source menu.

Source	Level	Slope	Coupling	HF Reject	Hysteresis	SIMPLE Hold Off (uS)
CH1	0.000 U	f	DC	OFF	ON	0.00

3. Press the **Ext** soft key. (Ch3 and CH4 are not displayed on the DL1620.)

CH1	CH2	CH3	CH4	Ext	Line	SIMPLE Hold Off (uS)
						0.00

Setting the Trigger Level

4. If the jog shuttle control is not set to Level, press the **Level** soft key.

Source	Level	Slope	Probe	SIMPLE Hold Off (uS)
Ext	0.000 U	f	1:1	0.00

On the DL1620, the Range soft key is displayed in this box.

5. Turn the jog shuttle to set the trigger level.
You can use the arrow keys to move between the digits. In addition, pressing **RESET**, sets the trigger level to 0 V.

Setting the Trigger Slope

6. Press the **Slope** soft key to select f, \downarrow , or \uparrow .

Setting the probe attenuation

7. Press the **Probe** soft key to select 1 : 1 or 10 : 1.

Setting the Range (DL1620 only)

8. Press the **Range** soft key to select the range.
 ± 1 V or ± 10 V (when Probe is set to 1:1), or ± 10 V or ± 100 V (when Probe is set to 10:1)

6.6 Setting the External Trigger (SIMPLE)

Setting the Hold Off

9. Set the hold off time according to the procedures given in 6.4, "Setting the Hold Off Time."

Explanation

The external signal that is input through the EXT TRIG IN terminal on the rear panel of this instrument can be used to generate triggers.

Note

For details related to the specifications of the EXT TRIG IN terminal, see section 12.1.

Selecting the Trigger Source

Select Ext.

Setting the Trigger Level

Range: ± 2 V (for the DL1640/DL1640L)
 ± 1 V (for the DL1620 with the ± 1 V range selected)
 ± 10 V (for the DL1620 with the ± 10 V range selected)
Resolution: 5 mV (for the DL1640/DL1640L)
 5 mV (for the DL1620 with the ± 1 V range selected)
 50 mV (for the DL1620 with the ± 10 V range selected)

Setting the Trigger Slope

Select the trigger activation method relative to changes in trigger source level from the following three choices.

- \nearrow : Activated when the trigger source changes from below the trigger level to above the trigger level (rising).
- \searrow : Activated when the trigger source changes from above the trigger level to below the trigger level (falling).
- \updownarrow : Activated on either a rising edge or falling edge.

Setting the Probe Attenuation

When applying a trigger input signal to the EXT TRIG IN terminal (or EXT. terminal on the front panel of the DL1620) via a probe, select an attenuation that matches the probe attenuation.

1 : 1, 10 : 1

Setting the Hold Off

See section 6.4, "Setting the Hold Off Time."

6.7 Generating Triggers on the Power Signal (SIMPLE)

Relevant Keys

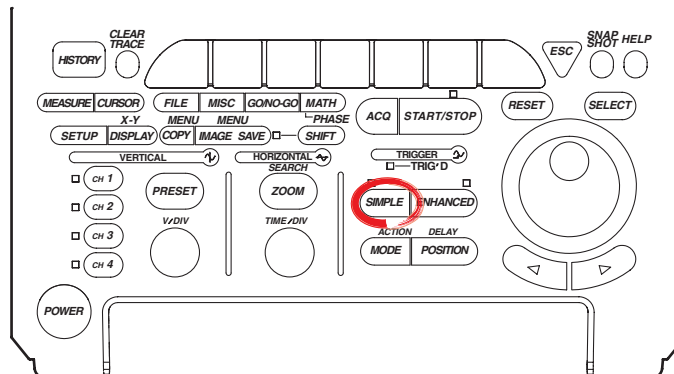

Operating Procedure

Setting the Trigger Source

1. Press **SIMPLE**.
2. Pressing the **Source** soft key displays the trigger source menu.

Source	Level	Slope	Coupling	HF Reject	Hysteresis	SIMPLE Hold Off (uS)
CH1	0.000 U	F	DC	OFF	ON	0.00

3. Press the **Line** soft key. (Ch3 and CH4 are not displayed on the DL1620.)

CH1	CH2	CH3	CH4	Ext	Line	SIMPLE Hold Off (uS)
						0.00

Setting the Hold Off

4. Set the hold off time according to the procedures given in 6.4, "Setting the Hold Off Time."

Source	Level	Slope	Coupling	HF Reject	Hysteresis	SIMPLE Hold Off (uS)
Line						0.00

Explanation

Triggers can be generated on the rising edge of the power signal that is being supplied to the instrument. Waveforms can be observed in sync with the commercial power supply frequency (50 Hz or 60 Hz).

Selecting the Trigger Source

Select Line.

Setting the Hold Off

See section 6.4, "Setting the Hold Off Time."

6.8 Setting the A→B(N) Trigger (ENHANCED)

<For a description of this function, see page 1-8>

Relevant Keys

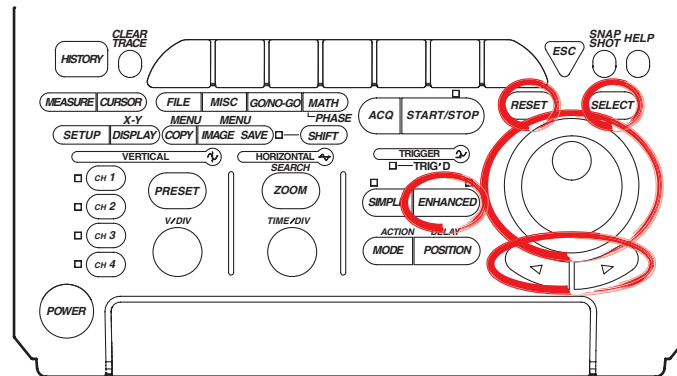

Operating Procedure

Setting the Trigger Type

1. Press **ENHANCED**.
2. Pressing the **Type** soft key to display the trigger type menu.

Type	Set Pattern	Level/ Coupling	Count	ENHANCED	Hold Off (μ S)
A → B(N)			1		0.00

3. Press the **A→B(N)** soft key.

A → B(N)	A Delay B	Pattern	Width	OR	TV	ENHANCED	Hold Off (μ S)
							0.00

Setting the Status and Condition for Conditions A and B

4. Pressing the **Set Pattern** soft key displays a menu used to set the status and condition for conditions A and B. (On the DL1620, settings for CH3 and CH4 are not displayed.)

Set Pattern							
A				B			
CH1							
CH2	X						
CH3	X						
CH4	X						
Condition		Enter	Enter				

Type	Set Pattern	Level/ Coupling	Count	ENHANCED	Hold Off (μ S)
A → B(N)			1		0.00

5. Set condition A. Turn the jog shuttle to move the cursor to the channel to which the status of condition A will be set.
6. Press **SELECT** to select H, L, or X.
7. Turn the jog shuttle to move the cursor to the Condition position of condition A.
8. Press **SELECT** to select Enter or Exit.
9. In a similar fashion, set condition B.

Setting the Level

- Pressing the **Level/Coupling** soft key displays a menu used to set the level, coupling, hysteresis, and HF rejection.

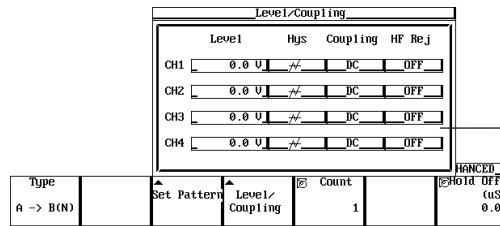

The Level setting for each channel can be input directly using a USB keyboard. (F6)

- Turn the jog shuttle to move the cursor to the channel on which the level is to be set.
- Press **SELECT** to display the level setting menu.
- Turn the jog shuttle to set the level.
You can use the arrow keys to move between the digits. In addition, pressing **RESET** sets the trigger level to 0 V.

Setting the Hysteresis

- Turn the jog shuttle to move the cursor to the channel on which hysteresis is to be set.
- Press **SELECT** to select Δ or ∇ .

Setting the Trigger Coupling

- Turn the jog shuttle to move the cursor to the channel on which the coupling is to be set.
- Press **SELECT** to select DC or AC.

Setting the HF Rejection

- Turn the jog shuttle to move the cursor to the channel on which the HF rejection (HF Rej) is to be set.
- Press **SELECT** to select ON or OFF.

Setting the Number of Times Condition B is to be Met

- If the jog shuttle control is not set to Count, press the **Count** soft key.

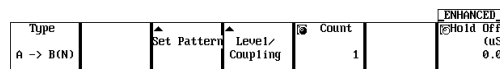

- Turn the jog shuttle to set the count.
You can use the arrow keys to move between the digits. Pressing **RESET** resets the value to 1.

Setting the Hold Off

- Set the hold off time according to the procedures given in 6.4, "Setting the Hold Off Time."

Note

- The status setting of conditions A and B applies to A -> B(N) trigger and A Delay B trigger.
- The trigger level, hysteresis, trigger coupling, and HF rejection settings apply to simple trigger and enhanced trigger.

6.8 Setting the A→B(N) Trigger (ENHANCED)

Explanation

This function activates a trigger on the nth time condition B becomes true after condition A becomes true.

Setting Conditions A and B

- **Channel Status**

Select the status of the channel from the following three choices.

H: Above the specified trigger level

L: Below the specified trigger level

X: Don't care

- **Condition**

Select from the following two conditions.

Enter: Trigger is activated when all channels meet the specified status.

Exit: Trigger is activated when at least one channel no longer meets the specified status.

The Number of Times Pattern B is to be Met

1 to 10⁸ times

Setting the Trigger Level

Range: 8 div within the screen

Resolution: 0.01 div

For example, the resolution is 0.02 mV when the V/DIV setting is 2 mV/div.

Setting the Hysteresis

Sets a width to the trigger level so that the trigger is not activated on small changes.

: Approximately 0.3 div* of hysteresis around the trigger level.

: Approximately 1 div* of hysteresis around the trigger level.

*: The values above are estimated values. They are not strictly guaranteed.

Setting the Trigger Coupling

Select from the following list of choices.

AC: Uses a signal that is obtained by removing the DC component from the trigger source signal as the trigger signal.

DC: Uses the trigger source signal as the trigger signal.

Turning ON/OFF the HF Rejection

Select ON when you wish to use a signal source obtained by removing the high-frequency components from the trigger signal as the trigger source.

Setting the Hold Off

See section 6.4, "Setting the Hold Off Time."

Note

If you wish to use only one pattern condition to activate the trigger, use the pattern trigger. If the status for condition A and condition B are set to Xs (Don't care), the trigger will not be activated.

6.9 Setting the A Delay B Trigger (ENHANCED)

<For a description of this function, see page 1-9>

Relevant Keys

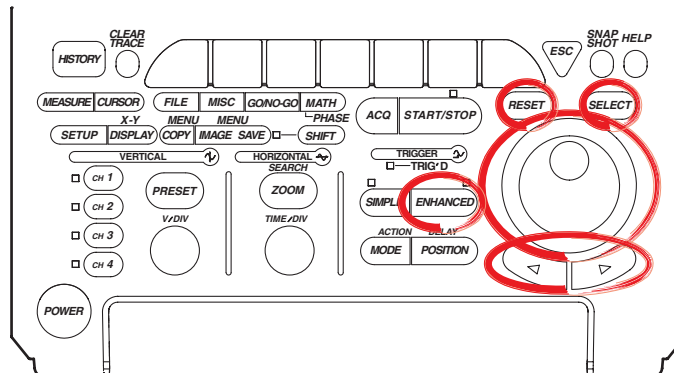

Operating Procedure

Setting the Trigger Type

1. Press **ENHANCED**.
2. Pressing the **Type** soft key to display the trigger type menu.

Type	Set Pattern	Level/ Coupling	Count	ENHANCED Hold Off (uS) 0.00
A -> B(N)			1	

3. Press the **A Delay B** soft key.

A -> B(N)	A Delay B	Pattern	Width	OR	TV	ENHANCED Hold Off (uS) 0.00

Setting the Status and Condition for Conditions A and B

4. Pressing the **Set Pattern** soft key displays a menu used to set the status and condition for conditions A and B. (On the DL1620, settings for CH3 and CH4 are not displayed.)

Type	Set Pattern	Level/ coupling	@Delay(uS)	ENHANCED Hold Off (uS) 0.00
A Delay B			0.003	

Set Pattern	
A	B
CH1	H L X
CH2	X L H
CH3	X X X
CH4	X X X
Condition	Enter Enter

5. Set condition A. Turn the jog shuttle to move the cursor to the channel to which the status of condition A will be set.
6. Press **SELECT** to select H, L, or X.
7. Turn the jog shuttle to move the cursor to the Condition position of condition A.
8. Press **SELECT** to select Enter or Exit.
9. In a similar fashion, set condition B.

6.9 Setting the A Delay B Trigger (ENHANCED)

Setting the Level, Hysteresis, Trigger Coupling, and HF Rejection

10. Pressing the **Level/Coupling** soft key displays a menu used to set the level, coupling, hysteresis, and HF rejection. (On the DL1620, settings for CH3 and CH4 are not displayed.)

The setting also applies to A→B(N) trigger. See section 6.8.

Level/Coupling				
Level	Hys	Coupling	HF Rej	
CH1	0.0 V	AC	DC	OFF
CH2	0.0 V	AC	DC	OFF
CH3	0.0 V	AC	DC	OFF
CH4	0.0 V	AC	DC	OFF

Type	Set Pattern	Level/Coupling	Delay (μs)	ENHANCED Hold Off (μs)
A Delay B			0.003	0.00

The Level setting for each channel can be input directly using a USB keyboard. (Ⓜ)

Setting the Delay Time

11. If the jog shuttle control is not set to Delay, press the **Delay** soft key.

Type	Set Pattern	Level/Coupling	Delay (μs)	ENHANCED Hold Off (μs)
A Delay B			0.005	0.00

12. Turn the jog shuttle to set the delay time.
You can use the arrow keys to move between the digits. Pressing **RESET** resets the value to 0.005 μs.

Setting the Hold Off

13. Set the hold off time according to the procedures given in 6.4, "Setting the Hold Off Time."

Note

- The status setting of condition A and B applies to A -> B(N) trigger and A Delay B trigger.
- The trigger level, hysteresis, trigger coupling, and HF rejection settings apply to simple trigger and enhanced trigger.

Explanation

This function activates a trigger the first time condition B becomes true after condition A becomes true and the specified time elapses.

Setting Conditions A and B

- **Channel Status**

Select the status of the channel from the following three choices.

H: Above the specified trigger level

L: Below the specified trigger level

X: Don't care

- **Condition**

Enter: Trigger is activated when all channels meet the specified status.

Exit: Trigger is activated when at least one channel no longer meets the specified status.

Delay Time

5 ns to 5 s (resolution: 5 ns)

Setting the Trigger Level

Range: 8 div within the screen

Resolution: 0.01 div

For example, the resolution is 0.02 mV when the V/DIV setting is 2 mV/div.

Setting the Hysteresis

Sets a width to the trigger level so that the trigger is not activated on small changes.

: Approximately 0.3 div* of hysteresis around the trigger level.

: Approximately 1 div* of hysteresis around the trigger level.

*: The values above are estimated values. They are not strictly guaranteed.

Setting the Trigger Coupling

Select from the following list of choices.

AC: Uses a signal that is obtained by removing the DC component from the trigger source signal as the trigger signal.

DC: Uses the trigger source signal as the trigger signal.

Turning ON/OFF the HF Rejection

Select ON when you wish to use a signal source obtained by removing the high-frequency components from the trigger signal as the trigger source.

Setting the Hold Off

See section 6.4, "Setting the Hold Off Time."

Note

If you wish to use only one pattern condition to activate the trigger, use the pattern trigger. If the status for condition A and condition B are set to Xs (Don't care), the trigger will not be activated.

6.10 Setting the Pattern Trigger (ENHANCED)

<For a description of this function, see page 1-9>

Relevant Keys

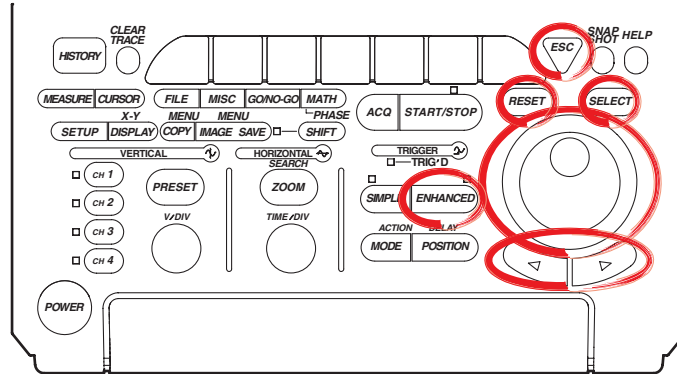

Operating Procedure

Setting the Trigger Type

1. Press **ENHANCED**.
2. Pressing the **Type** soft key displays the trigger type menu.

Type		Set Pattern	Level/ Coupling	Count	1	ENHANCED Hold Off (uS) 0.00
a -> B(N)						

3. Press the **Pattern** soft key.

a -> B(N)	a Delay B	Pattern	Width	OR	TV	ENHANCED Hold Off (uS) 0.00

Setting the Status and Condition

4. Pressing the **Set Pattern** soft key displays a menu used to set the status and condition. (CH3 and CH4 are not displayed on the DL1620.)

Set Pattern						
Clock CH <input type="checkbox"/> CH1						
CH1 <input type="checkbox"/>						
CH2 <input type="checkbox"/>						
CH3 <input type="checkbox"/>						
CH4 <input type="checkbox"/>						
Condition <input type="checkbox"/> True						
Type		Set Pattern	Level/ Coupling			ENHANCED Hold Off (uS) 0.00
Pattern						

When Activating the Trigger Only on the Status Pattern

5. Turn the jog shuttle to move the cursor to Clock CH.
6. Pressing **SELECT** displays the clock channel setting menu.
7. Turn the jog shuttle to select None. (CH3 and CH4 are not displayed on the DL1620.)

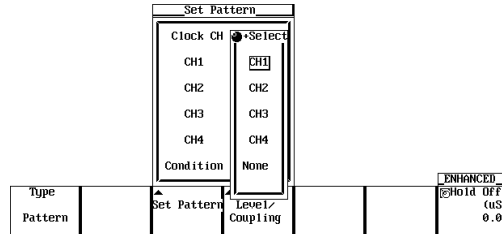

8. Press **ESC** and turn the jog shuttle to move the cursor to the channel on which the status is to be set.
9. Press **SELECT** to select H, L, X.
10. Turn the jog shuttle to move the cursor to Condition.
11. Press **SELECT** to select Enter or Exit. Go to step 14.

When Activating the Trigger in Sync with the Clock Channel

5. Turn the jog shuttle to move the cursor to Clock CH.
6. Pressing **SELECT** displays the clock channel setting menu.
7. Turn the jog shuttle to set the clock channel.
8. Press **ESC** and turn the jog shuttle to move the cursor to the channel that was set as the clock channel.
9. Press **SELECT** to select \overline{f} or \overline{L} .
10. Turn the jog shuttle to move the cursor to the channel to which the status to be set.
11. Press **SELECT** to select H, L, or X.
12. Turn the jog shuttle to move the cursor to Condition.
13. Press **SELECT** to select True or False.

Setting the Level, Hysteresis, Trigger Coupling, and HF Rejection of the Clock CH

14. Pressing the **Level/Coupling** soft key displays a menu used to set the level, coupling, hysteresis, and HF rejection. (On the DL1620, settings for CH3 and CH4 are not displayed.)

The setting also applies to the A→B(N) trigger. See section 6.8.

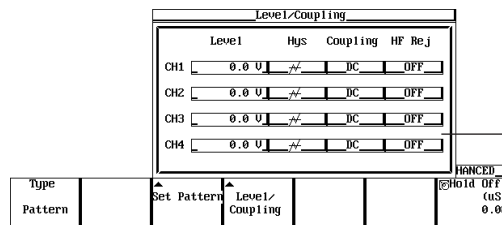

The Level setting for each channel can be input directly using a USB keyboard. (⌨)

Setting the Hold Off

15. Set the hold off time according to the procedures given in 6.4, "Setting the Hold Off Time."

Note

The trigger level, hysteresis, trigger coupling, and HF rejection settings apply to simple trigger and enhanced trigger.

6.10 Setting the Pattern Trigger (ENHANCED)

Explanation

This function activates the trigger when all conditions set to multiple trigger sources become true or when all conditions become false.

Setting the Trigger Source and Trigger Status

Set the trigger status of the trigger source from the following three choices.

- H: The trigger source level is greater than or equal to the trigger level.
- L: The trigger source level is less than or equal to the trigger level.
- X: Do not set as a trigger source.

Selecting the Clock Channel: Clock CH

- Select None if the trigger is not to be activated in sync with the signal.
- Select the clock channel from CH1 to CH4 (or CH1 to CH2 for the DL1620) if the trigger is to be activated in sync with the signal.
- Select the trigger slope from the following.
 - ↗: Rising
 - ↘: Falling

Selecting the Trigger Condition

• When Activating the Trigger Only on the Status Pattern

Select the trigger condition from the following list of choices.

Enter: Trigger is activated when the specified combination (pattern) is met.

Exit: Trigger is activated when the specified pattern is no longer met.

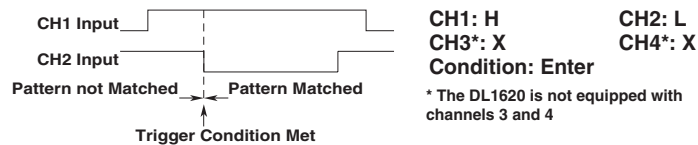

• When Activating the Trigger in Sync with the Clock Channel

Set the trigger condition from the following list of choices.

True: Trigger is activated on the rising or falling edge of the clock channel while the status pattern is being matched.

False: Trigger is activated on the rising or falling edge of the clock channel while the status pattern match condition is not satisfied.

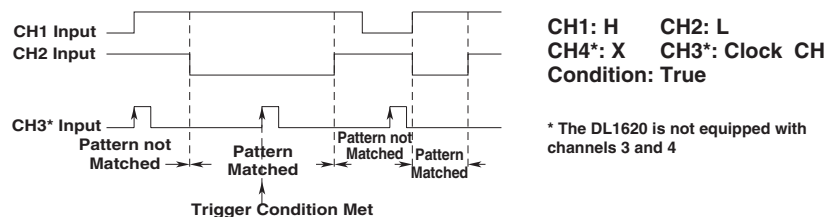

Setting the Trigger Level

Range: 8 div within the screen

Resolution: 0.01 div

For example, the resolution is 0.02 mV when the V/DIV setting is 2 mV/div.

Setting the Hysteresis

Sets a width to the trigger level so that the trigger is not activated on small changes.

↗: Approximately 0.3 div* of hysteresis around the trigger level.

↘: Approximately 1 div* of hysteresis around the trigger level.

*: The values above are estimated values. They are not strictly guaranteed.

Setting the Trigger Coupling

Select from the following list of choices.

AC: Uses a signal that is obtained by removing the DC component from the trigger source signal as the trigger signal.

DC: Uses the trigger source signal as the trigger signal.

Turning the HF Rejection ON/OFF

Select ON when you wish to use a signal source obtained by removing the high-frequency components from the trigger signal as the trigger source.

Setting the Hold Off

See section 6.4, "Setting the Hold Off Time."

Precautions to be Taken when Setting the Pattern Trigger

- When the trigger type setting is changed, the pattern trigger setting is no longer valid. However, if the pattern trigger is selected again, the previous settings are enabled.
- Even if the trigger mode is set to auto level mode, the operation will be in auto mode.
- Set the trigger status on all trigger sources. If the channel selected is a clock channel, select the trigger slope.
- When activating the trigger in sync with the clock signal, specify at least 1 ns for the pattern to setup and at least 1 ns for the hold time.

6.11 Setting the Width (Pulse<T, Pulse>T, T1<PLS<T2, T1<PLS<T2, Time Out) Trigger (ENHANCED)

<For a description of this function, see page 1-9>

Relevant Keys

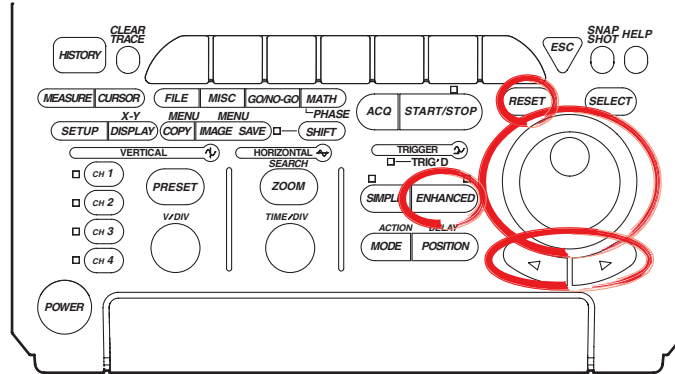

Operating Procedure

Setting the Trigger Type

1. Press **ENHANCED**.
2. Pressing the **Type** soft key displays the trigger type menu.

Type	Set Pattern	Level/Coupling	Count	ENHANCED
A -> B(N)			1	Hold Off (uS) 0.00

3. Press the **Width** soft key.

A -> B(N)	A Delay B	Pattern	Width	OR	TV	ENHANCED
						Hold Off (uS) 0.00

Setting the Width Type

4. Pressing the **Width Type** soft key displays a menu used to select the width type.

Type	Width Type	Set Pattern	Level/Coupling	Time(uS)	Window	ENHANCED
Width	Pulse<T			0.010	OFF ON	Hold Off (uS) 0.00

5. Press the soft key corresponding to the desired type from **Pulse>T**, **Pulse<T**, **T1<PLS<T2**, **T1<PLS<T2**, or **Time Out**.

Type	Pulse<T	Pulse>T	T1<PLS<T2	T1<PLS>T2	Time Out	ENHANCED
Width						Hold Off (uS) 0.00

Setting the Window

6. Press the **Window** soft key to select either ON or OFF.
 When the Window is turned OFF, a trigger is activated on the time period over which the parallel pattern of the channel state (H, L, and X) is met or not met.
 When the Window is turned ON, a trigger is activated on the time period over which the parallel pattern of the window condition of each channel is met or not met.

Type	Width Type	Set Pattern	Level/Coupling	Time(uS)	Window	ENHANCED
Width	Pulse<T			0.0075	OFF ON	Hold Off (uS) 0.00

6.11 Setting the Width (Pulse<T, Pulse>T, T1<PLS<T2, T1<PLS<T2, Time Out) Trigger (ENHANCED)

Setting the Conditions of Each Channel

- Press the **Set Pattern** soft key to display the trigger setting menu. (CH3 and CH4 are not displayed on the DL1620.)

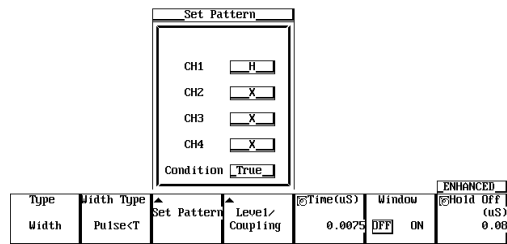

- Turn the jog shuttle to move the cursor to the channel to be set.
- Press **SELECT** to select H, L, X (when the Window is ON, IN, OUT, or X).
- Turn the jog shuttle to move the cursor to Condition.
- Press **SELECT** to select True or False.

Setting the Level, Hysteresis, Trigger Coupling, and HF Rejection

- Pressing the **Level/Coupling** soft key displays a menu used to set the level, coupling, hysteresis, and HF rejection. (On the DL1620, settings for CH3 and CH4 are not displayed.)

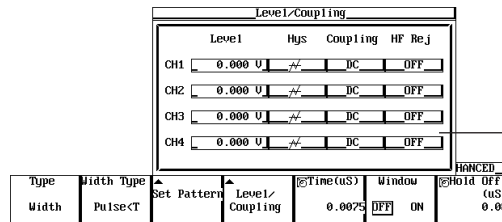

The Level setting for each channel can be input directly using a USB keyboard. (Ⓜ)

The setting also applies to A→B(N) trigger. See section 6.8.

When the Window is ON, set the window position, width, trigger coupling, and HF rejection. The settings are the same as the window trigger. See section 6.13, "Setting the Window Trigger."

Note

The trigger level, hysteresis, trigger coupling, and HF rejection settings apply to simple trigger and enhanced trigger.

6.11 Setting the Width (Pulse<T, Pulse>T, T1<PLS<T2, T1<PLS<T2, Time Out) Trigger (ENHANCED)

Setting the Determination Time

13. If the jog shuttle control is not set to Time press the **Time** soft key.

Type	Width Type	Set Pattern	Level/ Coupling	Time(μs)	Window	ENHANCED Hold Off (μs)
Width	Pulse<T			0.0075	OFF ON	0.00

If the Width Type is T1 < PLS < T2 or T1 < PLS < T2, press the **Time1/Time2** soft key.

Type	Width Type	Set Pattern	Level/ Coupling	Time1(μs)	Time2(μs)	Window	ENHANCED Hold Off (μs)
Width	T1<PLS<T2			0.001	0.002	OFF ON	0.00

14. Turn the jog shuttle to set the determination time.
You can use the arrow keys to move between the digits. Pressing **RESET** resets the pulse width to 0.005 μs or 0.0075 μs (Time2 is reset to 0.01 μs).

Setting the Hold Off

15. Set the hold off time according to the procedures given in 6.4, "Setting the Hold Off Time."

Explanation

- Pulse > T: When the time during which the status pattern is met is longer than the specified determination time, the trigger is activated when the condition changes.
 - Pulse < T: When the time during which the status pattern is met is shorter than the specified determination time, the trigger is activated.
 - T1<PLS<T2: When the time during which the status pattern is met is between the two specified determination time, the trigger is activated.
 - T1<PLS<T2: When the time during which the status pattern is met is not between the two specified determination time, the trigger is activated.
 - Time Out: The trigger is activated when the time during which the status pattern is met becomes longer than the specified determination time.
- The point at which the trigger is activated differs between Pulse > T and Time Out as indicated in the figure below.

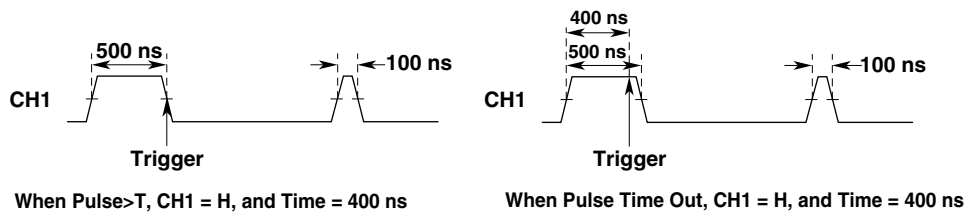

Pulse<T Setup Example

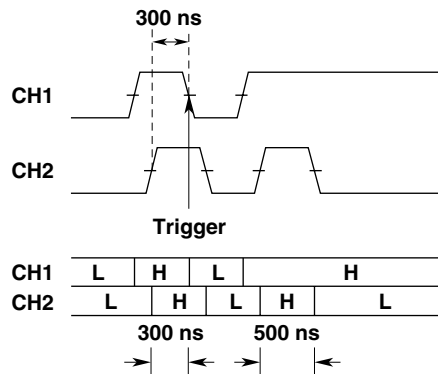

Pulse<T, Condition: CH1 = H, CH2 = H, Condition = True, Time = 400 ns

Conditions of Each Channel

When the window trigger turned OFF, the conditions same as the A→B(N) trigger. See section 6.8.

Same as the window trigger when the window is ON (IN/OUT/X).

For details regarding the window trigger, see section 6.13, “Setting the Window Trigger.”

Determination Time

- Pulse<T : 7.5 ns to 1 s
- Pulse>T : 5 ns to 1 s
- T1<Pulse<T2 : 5 ns to 1 s
- T1<Pulse<T2 : 7.5 ns to 1 s
- Time out : 5 ns to 1 s

6.11 Setting the Width (Pulse<T, Pulse>T, T1<PLS<T2, T1<PLS<T2, Time Out) Trigger (ENHANCED)

Precautions to be Taken when Setting the Width Trigger

The trigger may not operate properly if the time between two pulses is less than 2 ns or if the pulse width is less than 2 ns. The time accuracy of the pulse width in the standard operating condition after calibration is $\pm(0.5\% \text{ of the setting}^* + 1 \text{ ns})$.

*: When set to T1<PLS<T2, the value of T2.

Correlation with the Window Trigger

When the Window is turned ON, a trigger is activated based on the time period during which the parallel pattern of the window condition of each channel is met or not met.

Setting the Trigger Level

Range: 8 div within the screen

Resolution: 0.01 div

For example, the resolution is 0.02 mV when the V/DIV setting is 2 mV/div.

Setting the Hysteresis

Sets a width to the trigger level so that the trigger is not activated on small changes.

$\overline{\Delta}$: Approximately 0.3 div* of hysteresis around the trigger level.

$\overline{\Delta}$: Approximately 1 div* of hysteresis around the trigger level.

*: The values above are estimated values. They are not strictly guaranteed.

Setting the Trigger Coupling

Select from the following list of choices.

AC: Uses a signal that is obtained by removing the DC component from the trigger source signal as the trigger signal.

DC: Uses the trigger source signal as the trigger signal.

Turning ON/OFF the HF Rejection

Select ON when you wish to use a signal source obtained by removing the high-frequency components from the trigger signal as the trigger source.

Setting the Hold Off

See section 6.4, "Setting the Hold Off Time."

6.12 Setting the OR Trigger (ENHANCED)

<For a description of this function, see page 1-10>

Relevant Keys

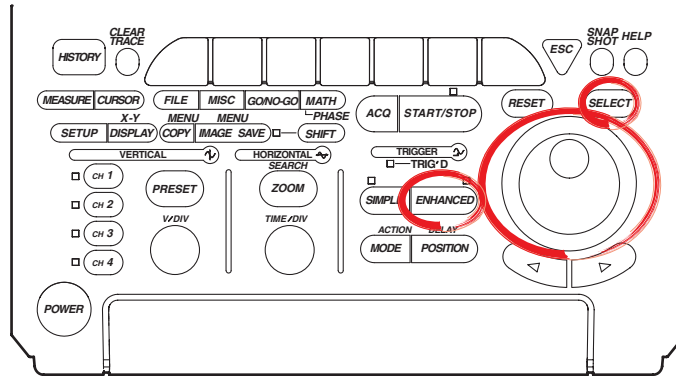

Operating Procedure

Setting the Trigger Type

1. Press **ENHANCED**.
2. Pressing the **Type** soft key displays the trigger type menu.

Type	Set Pattern	Level/ Coupling	Count	ENHANCED
A → B(N)			1	HOLD OFF (uS) 0.00

3. Press the **OR** soft key.

A → B(N)	A Delay B	Pattern	Width	OR	TV	ENHANCED
						HOLD OFF (uS) 0.00

Setting the Window

4. Press the **Window** soft key to select either ON or OFF.
If OFF is selected, triggers are activated on the OR of the channel edge.
If ON is selected, triggers are activated on the OR of the channel's window conditions.

Type	Set Pattern	Level/ Coupling	Window	ENHANCED
OR			OFF	HOLD OFF (uS) 0.00

Setting the Edge Trigger of Each Channel

5. Press the **Set Pattern** soft key to display the trigger setting menu. (CH3 and CH4 are not displayed on the DL1620.)

Set Pattern				
CH1	<input type="checkbox"/>			
CH2	<input type="checkbox"/>			
CH3	<input type="checkbox"/>			
CH4	<input type="checkbox"/>			
Type	Set Pattern	Level/ Coupling	Window	ENHANCED
OR			OFF	HOLD OFF (uS) 0.00

6. Turn the jog shuttle to move the cursor to the channel to be set.
7. Press **SELECT** to select \uparrow , \downarrow , or --- (when the Window is ON, IN, OUT, or ---).

6.12 Setting the OR Trigger (ENHANCED)

Setting the Level, Hysteresis, Trigger Coupling, and HF Rejection

- Pressing the **Level/Coupling** soft key displays a menu used to set the level, coupling, hysteresis, and HF rejection. (On the DL1620, settings for CH3 and CH4 are not displayed.)

Level/Coupling					
Level	Hys	Coupling	HF Rej		
CH1	0.0 V	AC	DC	OFF	
CH2	0.0 V	AC	DC	OFF	
CH3	0.0 V	AC	DC	OFF	
CH4	0.0 V	AC	DC	OFF	

Type	Set Pattern	Level/Coupling	Window	Hold Off (uS)	ENHANCED
OR			OFF ON		0.00

The Level setting for each channel can be input directly using a USB keyboard. (Ⓜ)

The setting also applies to A→B(N) trigger. See section 6.8.

When the Window is ON, set the window position, width, trigger coupling, and HF rejection. The settings are the same as the window trigger. See section 6.13, “Setting the Window Trigger.”

Note

The trigger level, hysteresis, trigger coupling, and HF rejection settings apply to simple trigger and enhanced trigger.

Setting the Hold Off

- Set the hold off time according to the procedures given in 6.4, “Setting the Hold Off Time.”

Explanation

This function activates a trigger on the OR of each channel's edge trigger.

Setting the Edge Trigger of Each Channel

Select from the following.

- ↗ : Rising
- ↘ : Falling
- : Don't care

Setting the Trigger Level

Range: 8 div within the screen

Resolution: 0.01 div

For example, the resolution is 0.02 mV when the V/DIV setting is 2 mV/div.

Setting the Hysteresis

Sets a width to the trigger level so that the trigger is not activated on small changes.

: Approximately 0.3 div* of hysteresis around the trigger level.

: Approximately 1 div* of hysteresis around the trigger level.

*: The values above are estimated values. They are not strictly guaranteed.

Setting the Trigger Coupling

Select from the following list of choices.

AC: Uses a signal that is obtained by removing the DC component from the trigger source signal as the trigger signal.

DC: Uses the trigger source signal as the trigger signal.

Turning ON/OFF the HF Rejection

Select ON when you wish to use a signal source obtained by removing the high-frequency components from the trigger signal as the trigger source.

Setting the Hold Off

See section 6.4, "Setting the Hold Off Time."

Correlation with the Window Trigger

If the window is turned ON, the trigger is activated when either the OR trigger or the window trigger becomes true. For details related to window trigger, see section 6.13, "Setting the Window Trigger."

6.13 Setting the Window Trigger (ENHANCED)

<For a description of this function, see page 1-10>

Relevant Keys

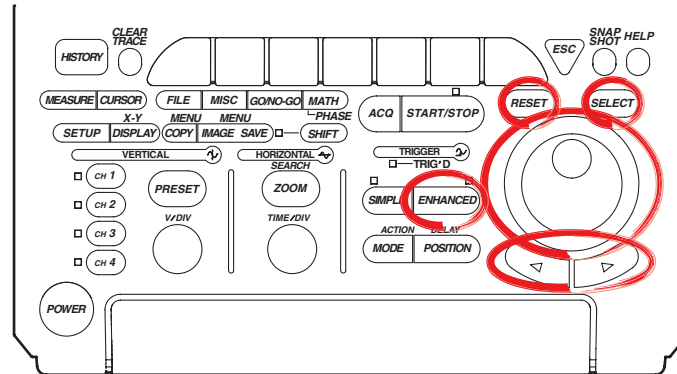

Operating Procedure

Setting the Trigger Type

1. Press **ENHANCED**.
2. Pressing the **Type** soft key displays the trigger type menu.

Type	Set Pattern	Level/ Coupling	Count	ENHANCED
A → B(N)			1	Hold OFF (uS) 0.06

3. Press the **OR** or **Width** soft key.

A → B(N)	A Delay B	Pattern	Width	OR	TU	ENHANCED
						Hold OFF (uS) 0.06

Setting the Window Trigger

4. Press the **Window** soft key to select ON.
Set the status and trigger conditions of each channel according to the procedures given in section 6.11, "Setting the Width (Pulse<T, Pulse>T, T1<PLS<T2, T1<PLS<T2, Time Out)" or 6.12, "Setting the OR Trigger (ENHANCED)."

Type	Set Pattern	Level/ Coupling	Window	ENHANCED
OR			OFF ON	Hold OFF (uS) 0.06

Setting the Center Level and Window Width

- Pressing the **Level/Coupling** soft key displays a dialog box used to set the center level, window width, trigger coupling, and HF rejection. (On the DL1620, settings for CH3 and CH4 are not displayed.)

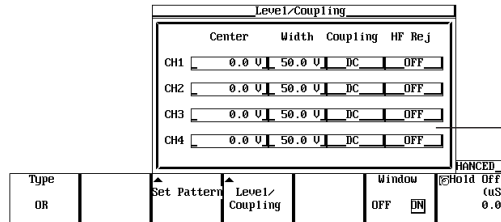

The Center and Width settings for each channel can be input directly using a USB keyboard.

- Turn the jog shuttle to move the cursor to the channel on which to set the window center level (Center).
- Press **SELECT** to display the center level menu.
- Turn the jog shuttle to set the center level. You can use the arrow keys to move between the digits. Pressing **RESET** sets the window center level to 0 V.
- Turn the jog shuttle to move the cursor to the channel on which to set the window width.
- Press **SELECT** to display the window width menu.
- Turn the jog shuttle to set the window width. You can use the arrow keys to move between the digits. Pressing **RESET** resets the value to the initial value.

Setting the Trigger Coupling and HF Rejection

- The coupling and HF rejection settings also apply to the A→B(N) trigger. See section 6.8.

Explanation

This function sets up a window trigger for the CH1 to CH4 (or CH1 to CH2 for the DL1620) input signal.

Trigger Condition

- Width trigger

IN: The time during the trigger source enters the window is trigger duration.

OUT: The time during the trigger source exits the window is trigger duration.

- OR trigger

IN: Trigger is activated when the trigger source enters the window (the area between two preset levels).

OUT: Trigger is activated when the trigger source exits the window.

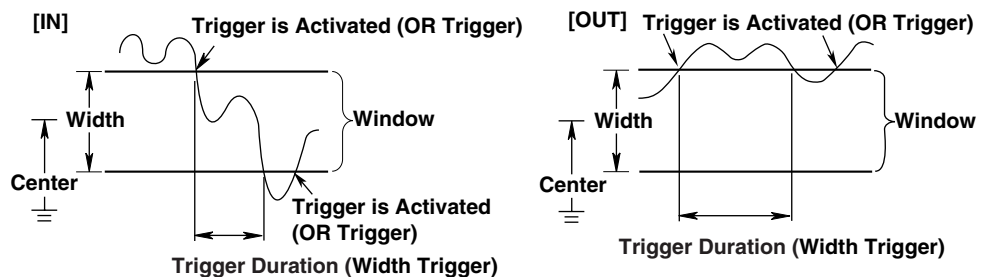

6.13 Setting the Window Trigger (ENHANCED)

Window Setting

You define the window by its center level and width.

“Center” Setting Range :Anywhere within the 8 screen divisions, in resolution of 0.01 div. (Example: If the scale is 1 V/div, resolution is 0.01 V).

“Width” Setting Range :Up to ± 4 div from center, in resolution of 0.02 div. (Example: If the scale is 1 V/div, resolution is 0.02 V).

Note

If you set the window so that the top or bottom is off the screen, the trigger will occur at the level for the corresponding screen edge (the level at ± 4 divisions from screen center) rather than at the “missing” top or bottom. Therefore it is recommended not to exceed ± 4 div when setting the window.

Setting the Trigger Coupling

Select from the following list of choices.

AC: Uses a signal that is obtained by removing the DC component from the trigger source signal as the trigger signal.

DC: Uses the trigger source signal as the trigger signal.

Turning ON/OFF the HF Rejection

Select ON when you wish to use a signal source obtained by removing the high-frequency components from the trigger signal as the trigger source.

Setting the Hold Off

See section 6.4, “Setting the Hold Off Time.”

Correlation with the OR Trigger or Width Trigger

OR and *Width* are the trigger types on which the window trigger can be used. When using the window trigger of a single channel, set the window conditions of all other channels to “-” or “x.”

6.14 Setting the TV Trigger (ENHANCED)

<For a description of this function, see page 1-10>

Relevant Keys

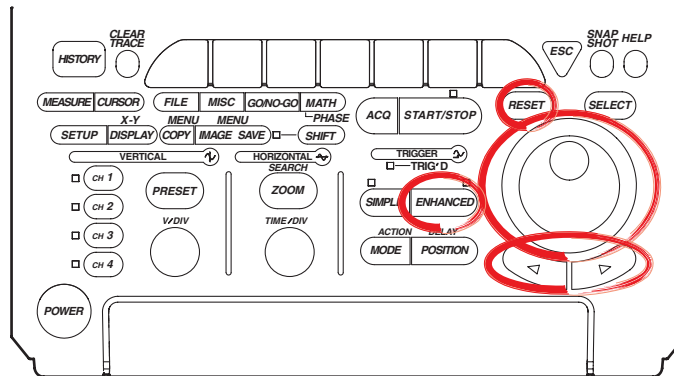

Operating Procedure

Inputting the Video Signal

Connect the probe (cable) used to input the video signal to the CH1 input terminal.

Selecting the TV Trigger

1. Press **ENHANCED**.
2. Pressing the **Type** soft key displays the trigger type menu.

Type	Set Pattern	Level/ Coupling	Count	ENHANCED Hold Off (uS)
A -> B(N)			1	0.00

3. Press the **TV** soft key.

A -> B(N)	A Delay B	Pattern	Width	OR	TV	ENHANCED Pulse Skip
						2 4 8

Selecting the Broadcasting System of the Video Signal to be Monitored

4. Pressing the **TV Type** soft key displays a menu used to select the broadcasting system.

Type	TV type	Polarity	Level	Field	Line	ENHANCED Frame Skip
TV	NTSC	Neg Pos	0.5div	2 X	5	2 4 8

5. Press the soft key corresponding to the desired format to select NTSC, PAL, SECAM, 1080/60i, 1080/50i, 720/60p, 480/60p, 1080/25p, 1080/24p, 1080/24sF, or 1080/60p.

NTSC	PAL	SECAM	1080/60i	1080/50i	720/60p	Next 1/2

Selecting the Polarity

6. Press the **Polarity** soft key to select the polarity.

Type	TV type	Polarity	Level	Field	Line	ENHANCED Frame Skip
TV	NTSC	Neg Pos	0.5div	2 X	5	2 4 8

6.14 Setting the TV Trigger (ENHANCED)

Setting the Trigger Level

7. If the jog shuttle control is not set to Level, press the **Level** soft key.
8. Turn the jog shuttle to set the trigger level.
You can use the arrow keys to move between the digits. Pressing **RESET** sets the trigger level to 0.5 div.

Selecting the Field Number

9. Press the **Field** soft key to select the number. You cannot set TV Type when 720/60p, 480/60p, 1080/25p, 1080/24p, or 1080/60p are set.

Selecting the Line Number

10. If the jog shuttle control is not set to Line, press the **Line** soft key.

Type	TV Type	Polarity	Level	Field	Line	ENHANCED Frame Skip
TV	NTSC	Neg/ Pos	0.5div	1 2 X	5	1 2 4 8

11. Turn the jog shuttle to set the line.
You can use the arrow keys to move between the digits. Depending on the TV Type setting, pressing **RESET** sets the smallest line value to No. 8.5 or 2.

Selecting Frame Skip

12. Press the **Frame Skip** soft key repeatedly to select the frame skip.

Explanation

This function lets you set a trigger for video signal input into Channel 1. Settings and functions are as follows.

Video Signal Formats with which the TV Trigger can be Used

NTSC, PAL, SECAM, 1080/60i, 1080/50i, 720/60p, 480/60p, 1080/25p, 1080/24p, 1080/24sF, and 1080/60p

Selecting the Field No.: Field

- 1 : Detects a field in which the vertical synchronizing pulse and the line start at the same time.
- 2 : Detects a field in which the vertical synchronizing pulse starts 1/2H (H: horizontal scan time) after the line starts.
- X : Detects both of the above types of field.

Selecting the Line No.: Line

A trigger is activated at the beginning of the selected line.

- **NTSC: 5 to 1054**

Field 1 starts at line No. "5." (Field 2 starts at line No. "268.")

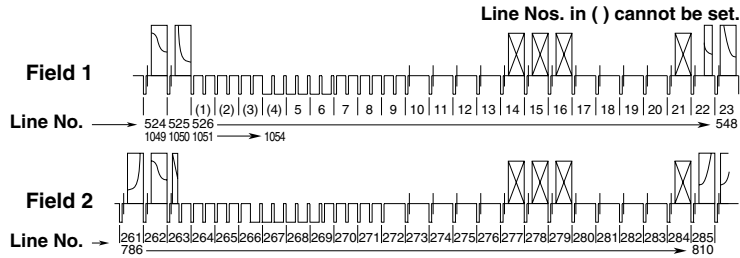

- **PAL, SECAM: 2 to 1251**

Field 1 starts at line No. "2." (Field 2 starts at line No. "315.")

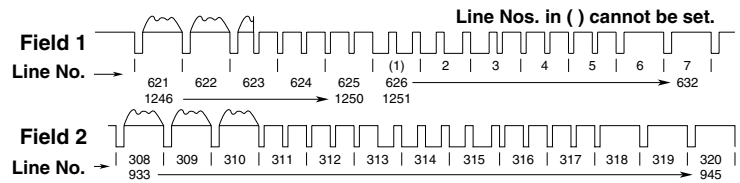

- **1080/60I, 1080/50I, 1080/24sF: 2 to 2251**

Field 1 starts at line No. "2." (Field 2 starts at line No. "565.")

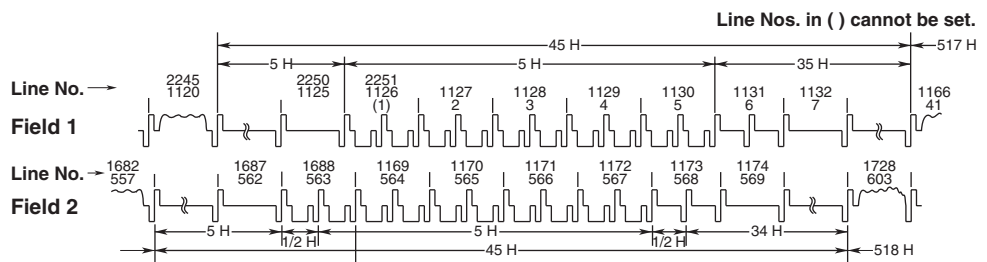

- **1080/25p, 1080/24p, 1080/60p: 2 to 2251**

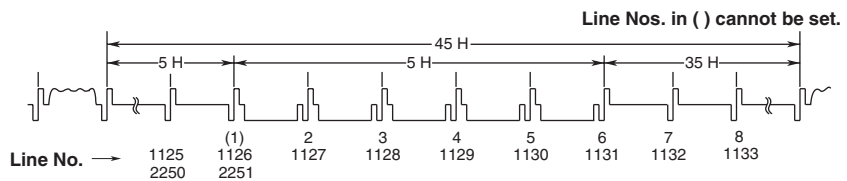

- **720/60p: 2 to 2251**

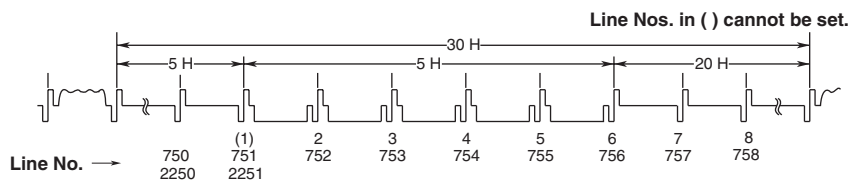

6.14 Setting the TV Trigger (ENHANCED)

- 480/60p: 8 to 2251

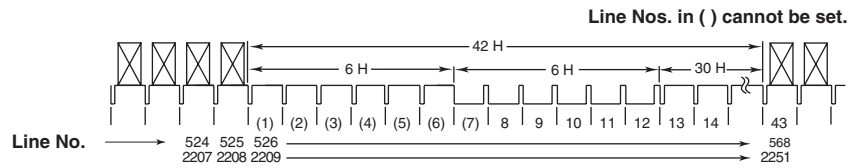

Selecting the Polarity

NTSC, PAL, SECAM, and 480/60p

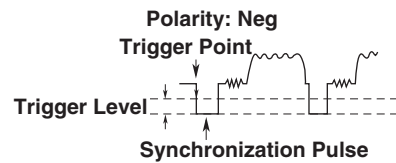
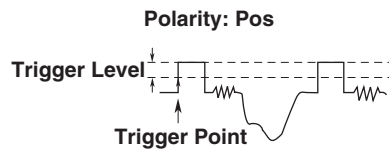

Others

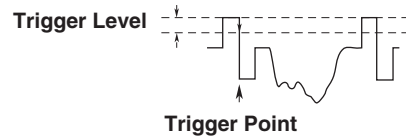
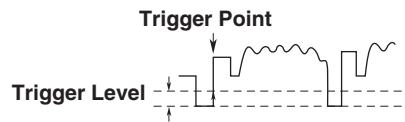

Setting the Trigger Level: Level

Set the difference between the beginning of the synchronization pulse and the level at which the trigger level is judged.

The setting range is from 0.1 div to 2.0 div. The setting resolution is 0.1 div.

The default setting is 0.5 div.

Setting the Frame Skip: Frame

This is a function for skipping frames when the color burst is inverted on every frame.

You can select how many frames to skip from the following choices.

Frame1: Trigger every frame at the specified field.

Frame2: Trigger every two frames at the specified field.

Frame4: Trigger every four frames at the specified field.

Frame8: Trigger every eight frames at the specified field.

Precautions to be Taken when Setting the TV Trigger

- Video signals can only be input to CH1. All other channels do not support video signals.
- Hold-off, trigger coupling, and HF rejection settings are ignored.

6.15 Setting the Action-On Trigger

<For a description of this function, see page 1-11>

Relevant Keys

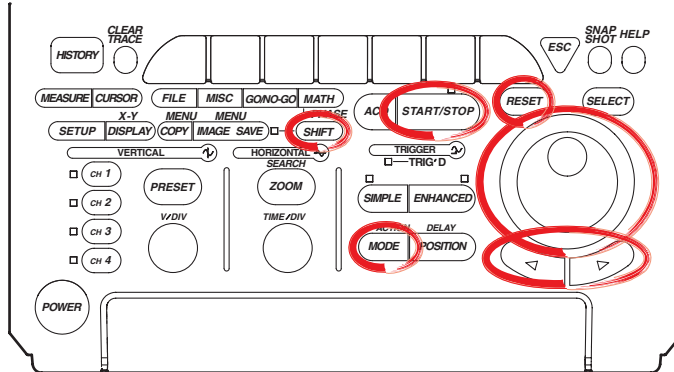

Operating Procedure

1. Press **SHIFT** to activate shift mode.
Functions marked in purple on the panel become active.
2. Press **MODE**.

Turning ON/OFF the Action

3. Press the soft key corresponding to the action you wish to enable and select ON.

					ACTION	
Buzzer	Save to File	Hard Copy	Image Save	ACQ Count	Send Mail	Exec
OFF ON	OFF ON	OFF ON	OFF ON	Infinite	MailCount 100	

Selecting the Number of Waveform Acquisitions

4. Turn the jog shuttle to set the waveform acquisition count.
You can use the arrow keys to move between the digits. In addition, pressing **RESET** sets the count to Infinite.

Executing the Action-On-Trigger

5. Pressing the **Exec** soft key starts the waveform acquisition and executes the action-on-trigger.

Aborting the Action-On-Trigger

6. Pressing the **Abort** soft key or **START/STOP** stops the waveform acquisition and aborts the action-on-trigger.

Explanation

Operation to Perform when the Trigger is Activated:

The specified operation from the following list is performed every time a trigger is activated.

- Hard Copy:** Outputs the screen image data to the destination (Built-in, USB, or Net Print (Ethernet interface option)) that was specified in “Copy to” of the Copy menu.
- Image Save:** Saves the screen image data to the output destination (FD, Zip disk, PC card, internal flash memory, USB storage, or network drive) that you specified in the Image Save menu.
- Save to File:** Saves the waveform data, the automated measurement value of waveform parameters, or snapshot waveforms to the storage medium (FD, Zip disk, PC card, internal flash memory, USB storage, or network drive) specified in the File menu.
- Buzzer:** Sounds an alarm.
- Send Mail:** Sends a mail (Ethernet Interface option): For details, see section 13.7, “Using the Mail Function (Action Mail Function).”

Note

When the action-on-trigger is started, the specified operation is performed when the trigger is activated in the normal mode regardless of the trigger mode setting.

Number of Operations: ACQ Count

- 1 to 65536: Repeats the operation the specified number of times.
- Infinite: Repeats the operation until the waveform acquisition is stopped.

Save to File/Hard Copy/Image Save Operation

Operates according to the settings in the FILE, COPY, or Image Save menu.

File name of Image Save or Save to File.

Saved using AUTO Name. For details, see section 10.4, “Storing Screen Image to the External Storage Medium” or section 11.6, “Saving/Loading Waveform Data.”

Send Mail Operation

Sends e-mail messages to the address specified through MISC > NetWork > Mail Setup > Mail Address.

Precautions to be Taken when Setting the Action-On-Trigger

- Action-on-trigger cannot be used when the action mode is Average or Box Average.
- The settings cannot be changed during an action-on-trigger.

Trigger Mode

The trigger mode is set to Single.

7.1 Setting the Record Length

<For a description of this function, see page 1-14>

Relevant Keys

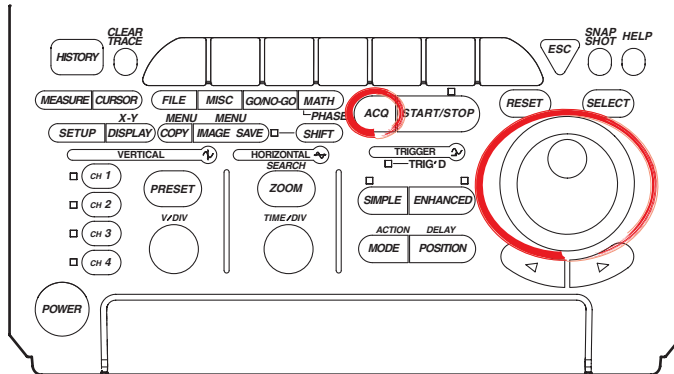

Operating Procedure

1. Press **ACQ**.
2. Press the **Record Length** soft key to display the record length setting menu.

Record Length	Mode	Count	Hireso Mode	Repetitive	Time Base
10k	Normal	Infinite	OFF	ON	Int Ext

3. Press the soft key of the record length that you want to set.

Explanation

The record length sets the amount of data to be written into the acquisition memory. Available length settings are as follows:

DL1620/ : 1 kword, 10 kwords, 100 kwords, 1 Mword, 8 Mwords (in high-resolution mode, 4 Mwords)

DL1640L : 1 kword, 10 kwords, 100 kwords, 1 Mword, 4 Mwords, 10 Mwords, 32 Mwords (in high-resolution mode, 16 Mwords)

Setting Precautions

- The sampling rate and displayed record length vary according to the T/div setting. For details, see Appendix 1.
- If the record length was modified because of the T/div setting, the number of history waveforms that can be saved according to the record length:
 - When the record length is set to 1 Mword (with the DL1640L, 4 Mwords), the number of history waveforms that can be saved depends on the record length modified by the T/div setting.
 - When the record length is set to any length except 1 Mword (with the DL1640L, 4 Mwords), the number of history waveforms that can be saved depends on that record length.
- The maximum record length for the high-resolution mode is half the maximum record length when the high-resolution mode is OFF on all models.

7.2 Acquisition Mode

<For a description of this function, see page 1-15>

Relevant Keys

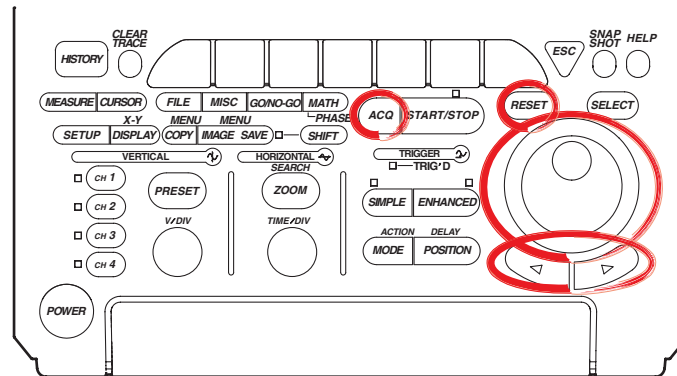

Operating Procedure

Setting the Acquisition Mode

1. Press **ACQ**.
2. Press the **Mode** soft key to display the acquisition mode menu.

Record Length	Mode	Count	Hi-Res Mode	Repetitive	ACQ Time Base
1H	Normal	Infinite	OFF	ON	[Int] Ext

3. Press the soft key corresponding to the desired mode from **Normal**, **Envelope**, or **Average**.

You may not be able to select some modes depending on the record length and sample rate settings.

Record Length	Mode	Count	Hi-Res Mode	Repetitive	ACQ Time Base
1H	Normal	Infinite	OFF	ON	[Int] Ext
	Envelope				
	Average				

Setting the Acquisition Count

4. Press the **Count** soft key.
This is not available when the trigger mode is Single or Single (N).

Record Length	Mode	Count	Hi-Res Mode	Repetitive	ACQ Time Base
1H	Normal	Infinite	OFF	ON	[Int] Ext

5. Turn the jog shuttle to set the acquisition count.
You can use the arrow keys to move between the digits.
In addition, pressing **RESET** sets the count to Infinite.
When the acquisition mode is Average and you have selected Infinite, go to step 6.

Setting the Attenuation (When the Acquisition Mode is Average and the Count is Set to Infinite)

6. Press the **Weight** soft key.

Record Length	Mode	Count	Weight	Hi-Res Mode	Repetitive	ACQ Time Base
1H	Average	Infinite	16	OFF	ON	[Int] Ext

7. Turn the jog shuttle to set the attenuation.

Explanation

You can select any of three acquisition modes, as follows. The default selection is Normal.

Normal

The instrument writes sample data into acquisition memory without performing special processing.

Envelope

The instrument finds the maximum and minimum sampled values per interval of 200 MS/s (100 MS/s when the high-resolution mode is ON). It then writes these values into acquisition memory, and generates an “envelope” waveform showing max/min levels for each point.

- **Setting Restriction**

This mode can be selected in normal mode when the time axis is 100 MS/s or lower (50 MS/s when the high-resolution mode is ON). For all other cases, the acquisition mode is set to normal even if envelope is specified.

Average

The instrument calculates average values and writes these into the acquisition memory. If the acquisition count is set to Infinite, the instrument uses exponential averaging, and you are required to set a Weight value. If the count is set to a numerical value (from 2 to 65536), the instrument calculates simple averages using the specified number of readings.

Exponential Averaging(Count=Infinite)

$$A_n = \frac{1}{N} \{(N - 1)A_{n-1} + X_n\}$$

A_n : Value Obtained after nth Averaging
X_n : nth Measured Value
N : Attenuation Constant
 (2 to 256, in Steps of 2ⁿ)

Linear Averaging(Count=2 to 65536)

$$A_N = \frac{\sum_{n=1}^N X_n}{N}$$

X_n : nth Measured Value
N : Number of Averaging Times
 (Acquisition Count,
 in Steps of 2ⁿ)

Exponential averaging cannot be used when trigger mode is single or single (N).

Simple averaging cannot be used with repetitive sampling. The maximum record length is 1 Mword (4 Mwords with the DL1640L) during simple averaging.

For more information about the relationship when roll mode or repetitive sampling mode is active or trigger mode is single or single (N), see Appendix 1.

Acquisition Count

The available count settings are indicated below. If you set the value to Infinite, acquisition will continue until you switch it off with **START/STOP**.

The default count is Infinite. You cannot change the acquisition count during measurement. The new value is activated when the measurement is stopped.

- If Normal or Envelope mode
2 to 65536 (in steps of 1), Infinite
- If Average mode
2 to 65536 (in steps of 2ⁿ), Infinite

Important Information about the Averaging Mode

- Averaging mode is useful when working with repetitive waveforms.
- Correct averaging is not possible if the waveform has imperfect triggering, since synchronization will be poor and the displayed waveform will be distorted. When working with this type of signal, set the trigger mode to Normal, so that the waveform display is updated only when the trigger occurs. (See section 6.1)
- Roll mode display is disabled during averaging.
- If you stop waveform acquisition by pressing **START/STOP**, the averaging process also stops. Averaging restarts from the beginning when acquisition resumes.
- If you are using simple averaging, the DL1620/DL1640/DL1640L terminates acquisition automatically when it completes the specified number of acquisitions (as set by the acquisition count).
- During repetitive sampling mode, only the exponential averaging is performed.

7.3 Using the Sequential Store Function

<For a description of this function, see page 1-16>

Relevant Keys

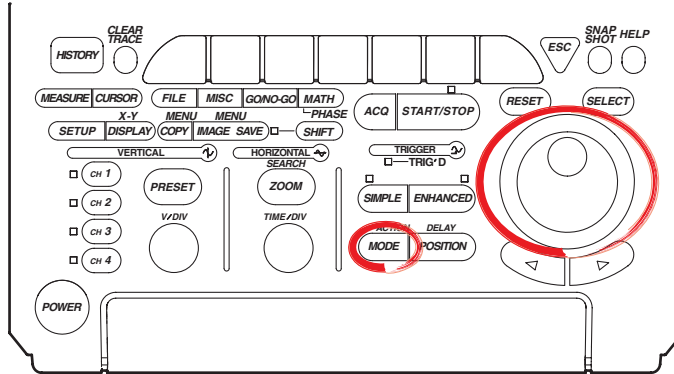

Operating Procedure

Setting the Trigger Mode

1. Press **MODE**.
2. Press the **Single(N)** soft key to set the trigger mode to Single(N).

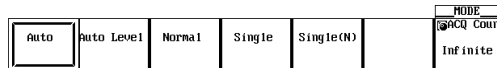

3. Turn the jog shuttle to set the **Single(N) Count**.

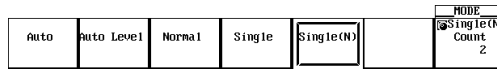

Explanation

By setting the trigger mode to Single(N), the sequential store function can be used.

Acquisition Count

Available numerical settings are as follows. The setting range varies according to the record length.

Record Length	DL1620/DL1640	DL1640L
1 kword	1 to 4000 (2000)	1 to 16000 (8000)
10 kwords	1 to 500 (250)	1 to 2000 (1000)
100 kwords	1 to 50 (25)	1 to 200 (100)
1 Mword	1 to 4 (2)	1 to 20 (10)
4 Mwords	–	1 to 4 (2)

* Values in parentheses above represent the maximum record lengths when the high-resolution mode is ON.

Waveform Display Method

You can recall waveforms from memory in the same way as you do when working with the history function. For details, see section 7.6, "Using the History Memory."

Restrictions and Precautions

- You can not use this mode together with repetitive sampling or roll mode.
- If you stop waveform acquisition by pressing **START/STOP**, sequential storage also stops. It then restarts again from the beginning when acquisition resumes.

7.4 Using the High-resolution Mode

<For a description of this function, see page 1-14>

Relevant Keys

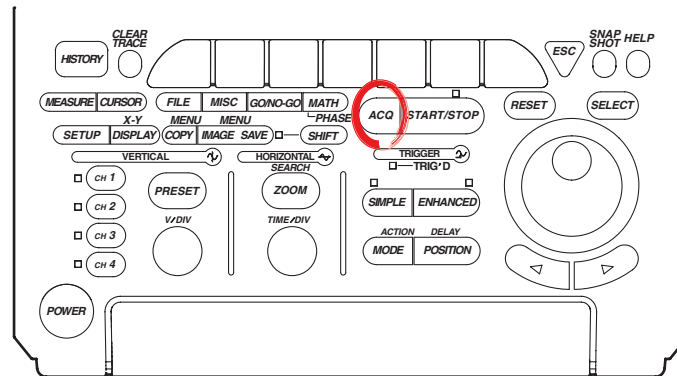

Operating Procedure

1. Press **ACQ**.
2. Press the **Hi-Res Mode** soft key to select ON or OFF.

Record Length	Mode	Count	Hi-Res Mode	Repetitive	Time Base
1M	Normal	Infinite	OFF	ON	Ext

Explanation

When Bandwidth (bandwidth limit) is not set to Full, high-resolution data exceeding 8 bits can be handled because noise included in the data is reduced through filtering. Ordinarily, data is saved in the acquisition memory as 8-bit data, so the resolution of high-resolution data that exceeds 8 bits is reduced to 8 bits and then saved. By turning ON the high-resolution mode, you can save this data as 16-bit data. This means that you can save high-resolution data exceeding 8 bits in a high-resolution format. When the high-resolution mode is ON, the record length is halved. (For the DL1620/ DL1640, 8 Mwords → 4 Mwords; for the DL1640L, 32 Mwords → 16 Mwords.)

7.5 Setting Repetitive Sampling Mode ON/OFF

<For a description of this function, see pages 1-7 and 1-16>

Relevant Keys

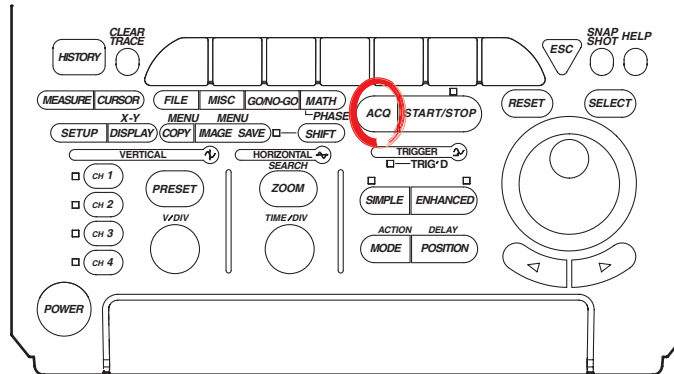

Operating Procedure

1. Press **ACQ**.
2. Press the **Repetitive** soft key to select ON or OFF.

Record Length	Mode	Count	Hi-Res Mode	Repetitive	Time Base
1M	Normal	Infinite	OFF	ON	INT Ext

Explanation

You can select whether or not to use repetitive sampling. If the repetitive sampling mode is ON, the sampling rate (for certain T/div settings) is set to 500 MS/s or above (200 MS/s or above when the high-resolution mode is ON).

If repetitive sampling mode is OFF, the maximum available sampling rate is 200 MS/s (or 100 MS/s when the high-resolution mode is ON), and the instrument will add interpolation to the displayed waveform if the number of display points is less than 500.

However, even if the repetitive sampling is turned OFF, the mode is set to repetitive sampling depending on the time axis setting.

T/div for Repetitive Sampling

If repetitive mode is ON, the sampling mode is switched to repetitive sampling for T/div settings as follows.

Available T/div setting varies according to the record length.

Record Length	T/div
1 kword	2 ns/div to 200 ns/div (2 ns/div to 500 ns/div)
10 kwords	2 ns/div to 2 μs/div (2 ns/div to 5 ms/div)
100 kwords	2 ns/div to 20 μs/div (2 ns/div to 50 μs/div)
1 Mword	2 ns/div to 20 μs/div (2 ns/div to 50 μs/div)
4 Mwords	2 ns/div to 20 μs/div (2 ns/div to 50 μs/div)
10 Mwords	2 ns/div to 20 μs/div (2 ns/div to 50 μs/div)
32 Mwords	2 ns/div to 20 μs/div (2 ns/div to 50 μs/div)

* Values in parentheses above are only available if the high-resolution mode is ON.

Restriction

During repetitive sampling, waveform acquisition is not possible when the trigger mode is Single (N).

7.6 Using the History Memory

<For a description of this function, see page 1-17>

Relevant Keys

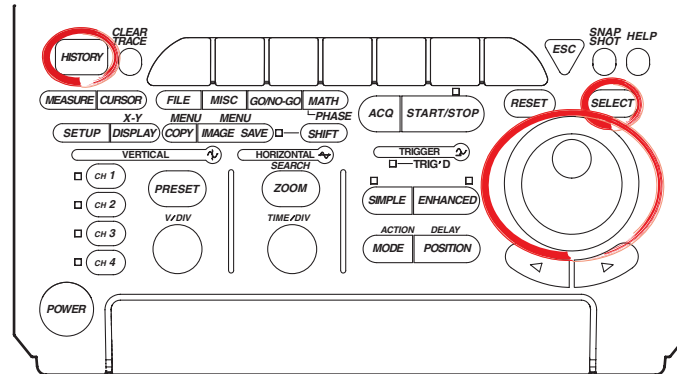

Operating Procedure

Recalling Data from the History Memory

1. Press **HISTORY**.
2. Press the **Select Record** soft key.

<input checked="" type="checkbox"/> Select Record	Display	<input checked="" type="checkbox"/> Start Rec	Show Map	Search Mode	HISTORY
0	One	0		OFF	
		<input checked="" type="checkbox"/> End Rec			
		0			

3. Turn the jog shuttle to set the record number that you wish to recall. Specify a record number in the range Start Rec to End Rec.
4. Press the **Display Mode** soft key to select One or All. Go to step 5 if you selected All. Otherwise, go to step 8.

Setting the Accumulation Range (When Display Mode is All)

5. Press the **Start Rec/End Rec** soft key.

<input checked="" type="checkbox"/> Select Record	Display	<input checked="" type="checkbox"/> Start Rec	Show Map	Search Mode	HISTORY
0	One	0		OFF	
		<input checked="" type="checkbox"/> End Rec			
		0			

6. Turn the jog shuttle to set the first record number to be accumulated.
7. In a similar fashion, set the end record number (End Rec).

Display a List of Time Stamps

- Pressing the **Show Map** soft key displays a list of acquired data numbers and the time at acquisition end.

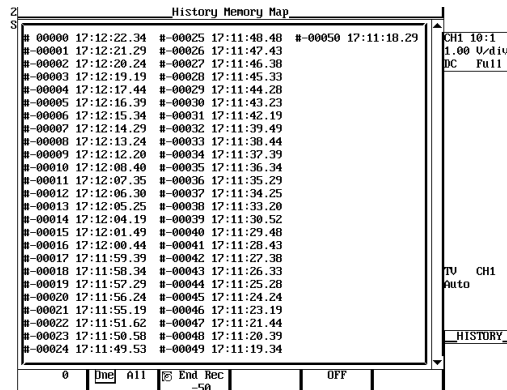

- Turn the jog shuttle to select the number of the waveform to be displayed and press **SELECT**. The waveform of the selected number is displayed.

Explanation

The acquisition memory retains waveform records generated by the most recent triggers. If a trigger is activated beyond the number of triggers that can be held, the oldest waveform data are cleared. Once the history becomes full, each new trigger causes loss of the oldest waveform record in the memory.

Selected Record Number

You can display any waveform from the history by entering its record number. The newest (current) waveform is Record 0, the immediately previous waveform is Record -1, and so on. The range for Selected Record No. is therefore [0 to - (retained waveforms - 1)]. The number of retained waveforms (triggers) depends on the record length, as follows.

Record Length	DL1620/DL1640	DL1640L
1 kword	1 to 4000 (2000)	1 to 16000 (8000)
10 kwords	1 to 500 (250)	1 to 2000 (1000)
100 kwords	1 to 50 (25)	1 to 200 (100)
1 Mword	1 to 4 (2)	1 to 20 (10)
4 Mwords	—	1 to 4 (2)
8 Mwords	1	—
10 Mwords	—	1
32 Mwords	—	1

* For each count of the trigger, only the displayed waveform is preserved; past waveform data is not preserved.

* Values in parentheses above are only available if the high-resolution mode is ON.

Display

- Set to One to display the selected record only.
Select the waveform to be displayed using Select Record from the specified range between Start Rec and End Rec.
- Set to All to generate overlapped display of all history records from the Start Rec No. to the End Rec No. The waveform corresponding to the Selected Record No. will appear brighter than the other waveforms.

Show Map (A List of Time Stamps)

You can list the number of the waveform data stored in the acquisition memory and the time at acquisition end.

One screen displays 75 data points of information. You can scroll through the data by using the jog shuttle.

Precautions and Restrictions

- You cannot use the history function while the acquisition mode is set to Average. (Displayed history records will be meaningless.)
- The history memory function cannot be used in repetitive sampling mode.
- If you suspend waveform acquisition before the current record has been fully read, the record will not be recorded in the history.
- You cannot use the history function while roll mode is selected.
- History records are not lost when waveform acquisition is stopped and then restarted, provided that acquisition conditions remain unchanged.
- If you change the acquisition settings, history memory is cleared when you restart acquisition using the new settings.
- If **CLEAR TRACE** is pressed during waveform acquisition or after the waveform acquisition is stopped, data in the history memory are cleared when the data acquisition is restarted.

Precautions to be Taken when Recalling Data from the History Memory

- Acquisition will stop when the history memory menu is displayed. It is not possible to recall waveform data from the history memory while acquisition is in progress.
- Acquisition can be restarted while the history memory menu is displayed. However, it is not possible to change history memory settings such as Selected Record No., while acquisition is in progress.
- Settings are restricted by the following formula.
$$\text{End Rec No.} \leq \text{Selected Record No.} \leq \text{Start Rec No.}$$
- If you load a waveform record from floppy disk, or external storage device, the loaded waveform becomes Record 0. In the case of multiple records (sequential store), the records will be loaded sequentially, with the latest record as 0.
- Computation and automatic measurement of waveform parameters are always performed on the currently displayed waveform, i.e. the waveform identified by the record No. designated for Selected Record No. Analysis of old data is possible as long as the history memory content remains unchanged after acquisition is restarted.
- In roll mode only the record most recently acquired when acquisition was stopped will be loaded into record No. 0.
- Time at acquisition end is displayed under Show map.
- Turning OFF the power will delete the entire contents of the history memory.

7.7 Searching the Historical Data Using Zone (History Search Function)

<For a description of this function, see page 1-26>

Relevant Keys

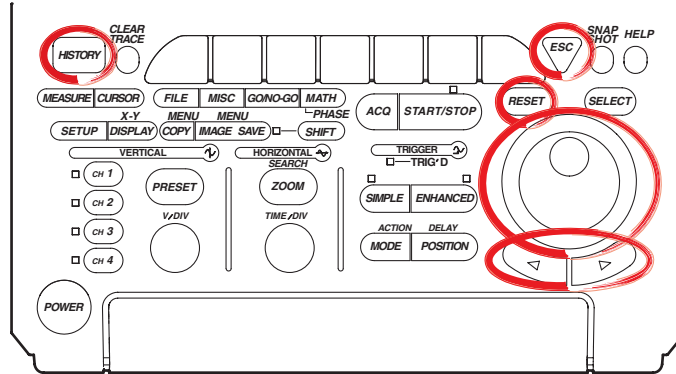

Operating Procedure

Selecting the Search Mode

1. Press **HISTORY**.
2. Pressing the **Search Mode** soft key displays the search mode selection menu.

Select Record	Display	Start Rec	Show Map	Search Mode	HISTORY
0	Time All	0 End Rec	0	OFF	

3. Press the **Zone** soft key .

Select Record	Display	Start Rec	Show Map	Zone	Parameter
0	Time All	0 End Rec	0	OFF	

Selecting the Search Zone (Select Zone)

4. Pressing the **Search Setup** soft key displays the search condition setting menu.

Select Record	Display	Start Rec	Show Map	Search Mode	Search Setup	HISTORY
0	Time All	0 End Rec	0	Zone		Search Exec

5. Press the **Select Zone** soft key to display the search condition selection menu.

Select Zone	Condition	Source	Upper	Left	Logic	Search
Zone1	OFF IN OUT	CH1	0.50d iv	-3.000d iv	AND OR	HISTORY
			-0.50d iv	-2.500d iv		Search Exec

6. Press one of the soft keys corresponding to **Zone1** to **Zone4**.

Zone1	Zone2	Zone3	Zone4	Left	Logic	Search
			-0.50d iv	-3.000d iv	AND OR	HISTORY
				-2.500d iv		Search Exec

Setting the Search Conditions (Condition)

7. Press the **Condition** soft key several times to select OFF, IN, or OUT. Selecting IN or OUT displays a search window in the area displaying the Source channel.

Select Zone	Condition	Source	Upper	Left	Logic	Search
Zone1	OFF IN OUT	CH1	0.50d iv	-3.000d iv	AND OR	HISTORY
			-0.50d iv	-2.500d iv		Search Exec

7.7 Searching the Historical Data Using Zone (History Search Function)

Setting the Source Channel (Source)

8. Pressing the **Source** soft key displays the source channel selection menu. (CH3 and CH4 are not displayed on the DL1620.)
9. Press the soft key corresponding to the desired channel to select the source channel.

CH1	CH2	CH3	CH4	Math1	Math2	Search
						HISTORY
			-0.50div	-2.50div		Search Exec

Setting the Search Window

10. Press the **Upper Lower** soft key.

Select Zone	Condition	Source	Upper 0.50div	Left -3.00div	Logic	Search
Zone1	OFF IN OUT	CH1	Lower -0.50div	Right -2.50div	AND OR	HISTORY
						Search Exec

11. Turn the jog shuttle to set the top of the search range. You can use the arrow keys to move between the digits. Pressing **RESET** resets the value to the default value.
12. Press the **Upper Lower** soft key.
13. Turn the jog shuttle to set the end of the search range. You can use the arrow keys to move between the digits. Pressing **RESET** resets the value to the default value.
14. By controlling both Upper and Lower using the jog shuttle, you can move the search window up and down without changing the vertical width.

Select Zone	Condition	Source	Upper 0.50div	Left -3.00div	Logic	Search
Zone1	OFF IN OUT	CH1	Lower -0.50div	Right -2.50div	AND OR	HISTORY
						Search Exec

15. In a similar fashion, set the horizontal range of the search window.
16. Repeat steps 6 to 15 to set Zone1 to Zone4.

Setting the Logic

17. Press the **Logic** soft key to select AND or OR.

Executing the Search

18. Press the **Search Exec** soft key to execute the search.

Displaying the Waveforms that are Found

19. Press **ESC** to return to the HISTORY menu.
20. Press the **Show Map** soft key to display a list of the numbers of the acquired waveform data and time at acquisition end.

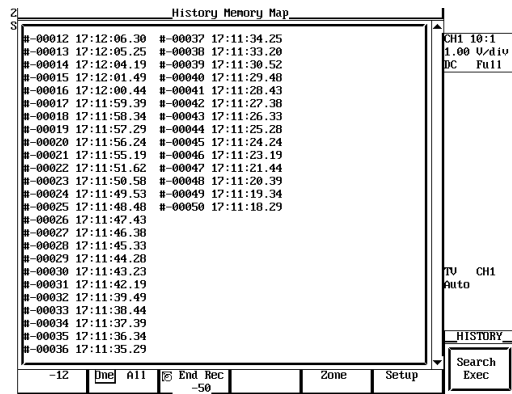

21. Turn the jog shuttle to select the waveform to be displayed and press **SELECT**.

Resetting the Search Results

22. Select **HISTORY > Search Mode > OFF** or turn OFF Zone 1 to Zone 4 and execute the search to reset the search results.

Explanation

You can search for a waveform that matches the specified conditions from the past waveforms in the acquisition memory and display it.

Search Parameters

Four types of search parameters can be registered in Zone1 to Zone4. You can change the channel that is to be searched, the search condition, and the search range for each search zone.

Search Condition: Condition

- IN: Searches for waveforms that pass through the specified search window.
- OUT: Searches for waveforms that do not pass through the specified window.
- OFF: Do not search for waveforms.

Source Channel: Source

Search is carried out on the channel that is specified as the Source. Waveforms of other channels are also displayed.

The Vertical Range of the Search Window (Upper/Lower)

The range is ± 4 div. The resolution is 0.01 div. Upper must always be greater than or equal to Lower.

The Horizontal Range of the Search Window (Left/Right)

The range is ± 5 div. The resolution is (10 div/displayed record length). Right must always be greater than or equal to left.

Search Logic: Logic

- AND: Searches for waveforms that meet all search conditions from Zone1 to Zone4.
- OR: Searches for waveforms that meet any one of the search conditions from Zone1 to Zone4.

7.7 Searching the Historical Data Using Zone (History Search Function)

Search Range of the Historical Data

The search range is between the Start Rec and the End Rec.

Search Order

The search is carried out from the newest waveform to the oldest waveform.

Show Map (A List of Time Stamps)

Only the waveforms that are found are displayed in Show Map. If the Search Mode is turned OFF, all waveforms are displayed.

7.8 Searching the Historical Data Using Parameters (History Search Function)

<For a description of this function, see page 1-26>

Relevant Keys

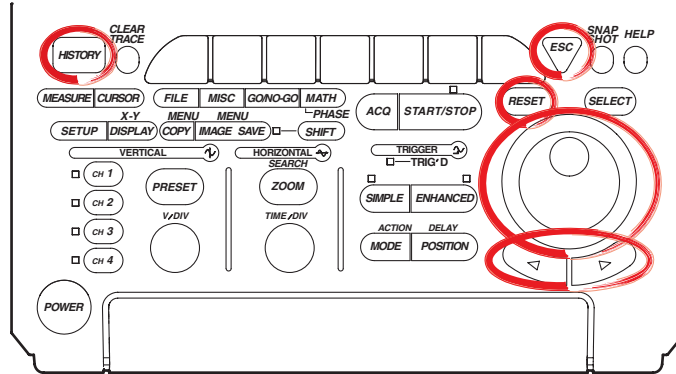

Operating Procedure

Select the Search Mode

1. Press **HISTORY**.
2. Press the **Search Mode** soft key to display the search mode selection menu.

Select Record	Display	Start Rec	End Rec	Show Map	Search Mode	HISTORY
0	All	0	-94		OFF	

3. Press the **Parameter** soft key.

Select Record	Display	Start Rec	End Rec	Show Map	OFF	Zone	Parameter
0	All	0	-94				

Select the Search Criteria (Select Param)

4. Press the **Search Setup** soft key to display the Search Criteria Setting menu.

Select Record	Display	Start Rec	End Rec	Show Map	Search Mode	Search Setup	HISTORY
0	All	0	-94		Parameter		

5. Press the **Select Param** soft key to display the search criteria selection menu.

Select Param	Condition	Item Setup	Upper	Lower	Logic	T-Range1	T-Range2	Search Exec
Param1	OFF	CH1	XXX	XXX	AND	-5.000d10	5.000d10	

6. Press one of the soft keys for **Param1 - Param4** to select the search criterion.

Param1	Param2	Param3	Param4	Logic	T-Range1	T-Range2	Search Exec
		P-P	XXX	AND	-5.000d10	5.000d10	

Setting the Condition

7. Press the **Condition** soft key to select OFF, IN, or OUT.

Select Param	Condition	Item Setup	Upper	Lower	Logic	T-Range1	T-Range2	Search Exec
Param1	OFF	CH1	XXX	XXX	AND	-5.000d10	5.000d10	

7.8 Searching the Historical Data Using Parameters (History Search Function)

Setting the Parameter (Item Setup)

8. Press the **Item Setup** soft key to display the parameter selection menu.
9. Press the soft key corresponding to the channel that you wish to set as the source channel for the parameter search. (CH3, CH4, and Math2 are not displayed on the DL1620.)

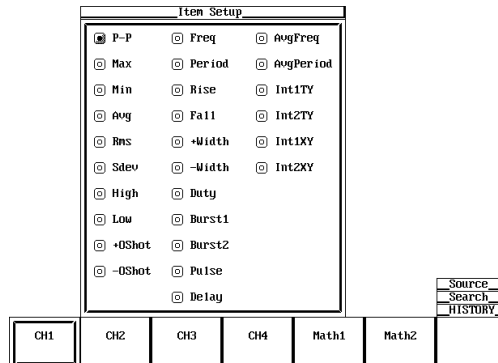

10. Use the jog shuttle to highlight the parameter to be used in the search, then press **SELECT** to assign the parameter to the channel.

Set the Condition Range

11. Press the **Upper Lower** soft key to highlight the Upper jog shuttle icon.

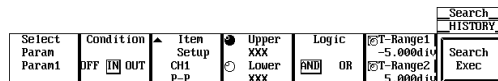

12. Turn the jog shuttle to set the upper edge of the condition range. Use the arrow keys to move between the digits. Press **RESET** to return to the initial value (XXX).
13. Press the **Upper Lower** soft key to highlight the Lower jog shuttle icon.
14. Turn the jog shuttle to set the lower edge of the condition range. Use the arrow keys to move between the digits. Press **RESET** to return to the initial value (XXX).
15. Repeat steps 6 - 14 to set Param1 through Param4.

Setting the Logic

16. Press the **Logic** soft key to select AND or OR.

Setting the Parameter Measuring Range

17. Press the **T-Range1/T-Range2** soft key to highlight T-Range1.

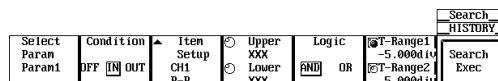

18. Turn the jog shuttle to set the left edge of the measuring range. Use the arrow keys to move between the digits. Press **RESET** to return to the initial value.
19. Press the **T-Range1/T-Range2** soft key to highlight T-Range2.
20. Turn the jog shuttle to set the right edge of the measuring range. Use the arrow keys to move between the digits. Press **RESET** to return to the initial value.

Executing the Search

21. Press the **Search Exec** soft key to execute the search.

Displaying the Searched Waveform

22. Press **ESC** to return to the HISTORY menu.
23. Press the **Show Map** soft key to display a list of the numbers of the searched waveform data and time at acquisition end.

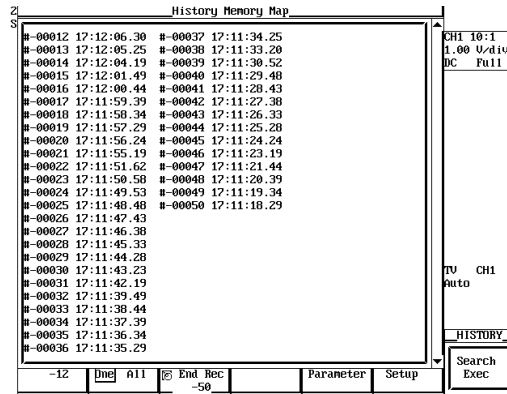

24. Turn the jog shuttle to select the waveform to be displayed and press **SELECT**.

Resetting the Search Results

25. If you set the Search Mode to OFF in the HISTORY menu, or if you perform a search with all of the parameters (Param1-Param4) set to OFF, the search results will be reset.

Explanation

Search for waveforms from the history memory function and display only the waveforms that fulfill specified conditions of particular parameters.

Search Criterion

You can store various kinds of search criteria in Param1-Param4. Within those four search criteria, you can specify the channel to be searched, the search conditions, and the searching range.

Condition

- IN: Search for a waveform entering the specified range of the specified parameter.
- OUT: Search for a waveform extending outside the specified range of the specified parameter.
- OFF: Do not search for a waveform.

Item Setup

Assign search parameters to each source channel. Choose (only) one of the automated waveform measurement parameters.

Condition Range (Upper/Lower)

Set the range that defines the specified parameter's condition.

Logic Search

- AND: Search for waveforms fulfilling all of the search criterion in Param1- Param4.
- OR: Search for waveforms fulfilling at least one of the search criterion in Param1- Param4.

7.8 Searching the Historical Data Using Parameters (History Search Function)

Parameter Measuring Range (T-Range1/T-Range2)

Set the measuring range of the specified parameter. This is the portion of the waveform used to determine the values of the parameter.

Search Range of the Historical Data

The search range extends from the Start Rec to the End Rec.

Search Method

Search in order starting with the newest waveform.

Show Map (Timestamp List)

Only searched waveforms are displayed in Show map. When Search Mode is OFF, all waveforms are displayed.

8.1 Changing the Display Format

<For a description of this function, see page 1-17>

Relevant Keys

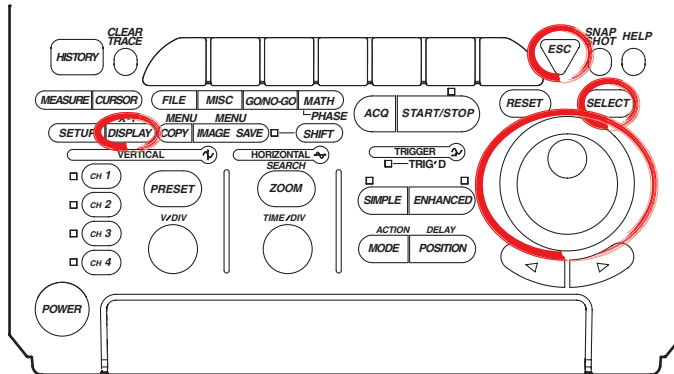

Operating Procedure

1. Press **DISPLAY**.
2. Pressing the **Format** soft key displays the format menu.

Format	Interpol	Graticule	Scale Value	Trace Label	Accumulate	DISPLAY
Quad	Sine		OFF ON	OFF ON	OFF	Next 1/2

3. Press the soft key corresponding to the desired format. (Quad is not displayed on the DL1620.)

Single	Dual	Quad	Scale Value	Trace Label	Accumulate	DISPLAY
			OFF ON	OFF ON	OFF	Next 1/2

4. Press the **Next 1/2** soft key to display the Next 2/2 menu.

Format	Interpol	Graticule	Scale Value	Trace Label	Accumulate	DISPLAY
Dual	Sine		OFF ON	OFF ON	OFF	Next 1/2

Press the **Mapping** soft key to select **Auto**, **Fixed**, or **User**.

Translucent	Mapping					DISPLAY
OFF ON	Auto					Next 2/2

Translucent	Auto	Fixed	User			DISPLAY
OFF ON						Next 2/2

5. Pressing the **Set Mapping** soft key displays a menu used to assign the waveforms. (On the DL1620, the CH3, CH4, and Math2 settings are not displayed.)

Translucent	Mapping	Set Mapping				DISPLAY
OFF ON	User	CH1 0				Next 2/2
		CH2 1				
		CH3 2				
		CH4 3				
		Math1 4				
		Math2 5				

8.1 Changing the Display Format

6. Turn the jog shuttle to move the cursor to the desired channel.
7. Pressing **SELECT** displays a menu used to set the number. (CH3, CH4, and Math2 are not displayed on the DL1620.)

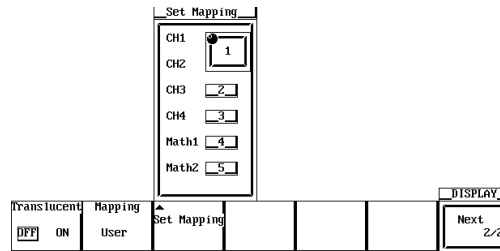

8. Turn the jog shuttle to select a number. Pressing **ESC** closes the menu.
9. Repeat steps 5 to 7 as necessary.

Explanation

Main Format

Single: 1 waveform window

Dual: 2 waveform windows

Quad: 4 waveform windows (DL1640 and DL1640L only)

Mapping

Auto*: Windows are arranged from top to bottom in order: CH1, CH2,..., Math1, Math2. But no windows are shown for channels whose display is set to OFF.

Fixed*: Channels are displayed, regardless of whether their display setting is ON or OFF, in order of channel number. The Math2 window is at the bottom with the Math1 window directly above it.

User*: Assign numbers from 0 to 5 to CH1, CH2, ..., Math1, and Math2. The display position varies depending on the assigned numbers.

* DL1620 is not equipped with channels 3, 4, and Math2.

Assignment Example when the Display Format is Set to Dual

CH1,	CH1, CH4	0, 2, 4
CH2, CH4	CH2,	1, 3, 5
Fixed (If CH3 = OFF)	Auto (If CH3 = OFF)	User

The number of points that can be displayed vertically for each channel varies as follows according to the display format. However, the vertical resolution remains unchanged.

Single(□): 383 points

Quad(☐): 95 points

Dual(☐): 191 points

8.2 Setting the Interpolation Method

<For a description of this function, see page 1-18>

Relevant Keys

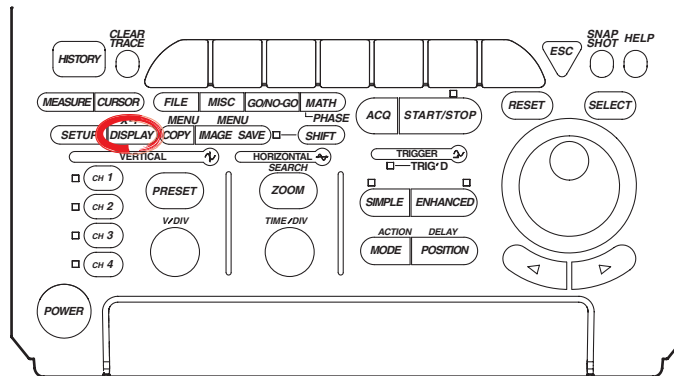

Operating Procedure

Set the Interpolation Method

1. Press **DISPLAY**.
2. Press the **Interpol** soft key to display the interpolation method menu.

Format	Interpol	Graticule	Scale Value	Trace Label	Accumulate	DISPLAY
Dual	Sine		OFF	ON	OFF	Next 1/2

3. Press the soft key corresponding to the desired interpolation method.

Format	Interpol	Graticule	Scale Value	Trace Label	Accumulate	DISPLAY
Dual	Line		OFF	ON	OFF	Next 1/2

Explanation

Interpolate

Any area along the time axis having less than 500 points per 10 divisions (less than 250 points in the Z1 and Z2 window when displaying Main & Z1 & Z2) is recognized as an interpolation area. If you leave interpolation off, these points will appear as discrete dots (so that the display will show gaps between dots or vertical lines). If you set interpolation on, however, the DL1640/DL1640L will connect the points. Three interpolation settings are available.

Sine (📈): Interpolates between two dots using a sin x/x function.

Line (—): Interpolates between two dots in a straight line.

PULSE (—): Draws a horizontal line to a point directly above or below the next data point and then interpolates using two dots so that the end of the horizontal line is connected to the next data point by a vertical line.

OFF (•••): No interpolation

8.2 Setting the Interpolation Method

Outside the Interpolation Area

If interpolation is set to Sine, Line, or Pulse the instrument draws lines between points that are aligned vertically.

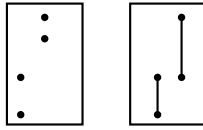

Interpolate: **OFF** **Sine/Line/Pulse**

Within the Interpolation Area

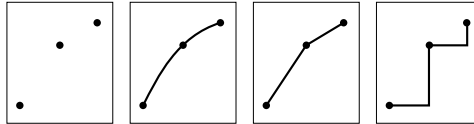

Interpolate: **OFF** **Sine** **Line** **Pulse**

8.3 Changing the Graticule

<For a description of this function, see page 1-17>

Relevant Keys

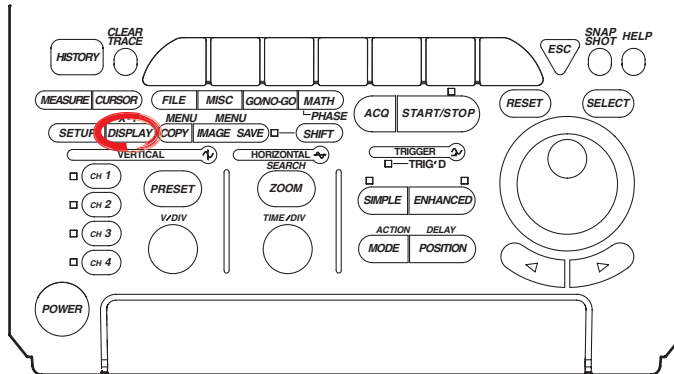

Operating Procedure

1. Press **DISPLAY**.
2. Press the **Graticule** soft key to select one of the three graticule types.

Format	Interpol	Graticule	Scale Value	Trace Label	Accumulate	DISPLAY
Dual	Sine		OFF ON	OFF ON	OFF	Next 1/2

Explanation

The graticule type can be selected from the following 3 types.

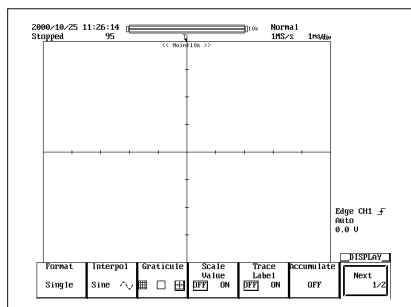
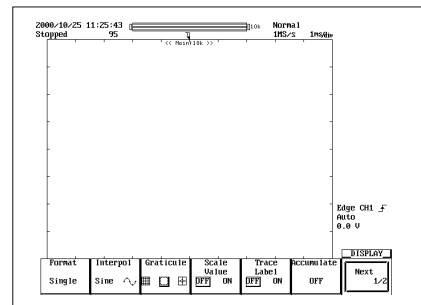
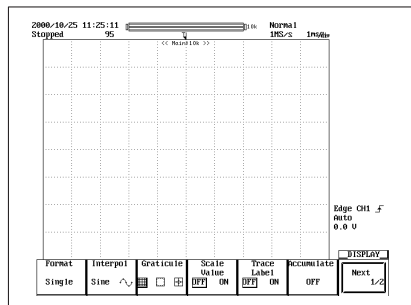

8.4 Turning Display of the Scaling Value ON/OFF

<For a description of this function, see page 1-17>

Relevant Keys

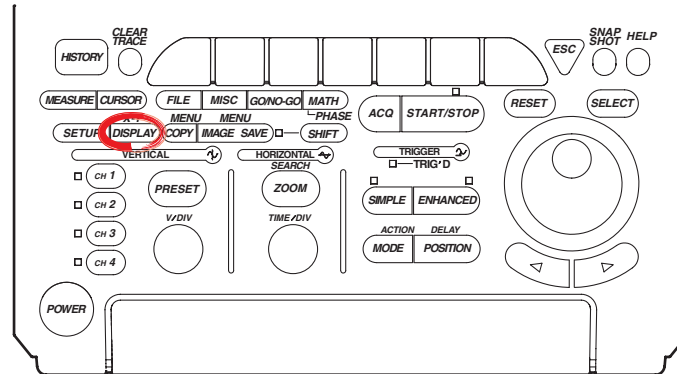

Operating Procedure

1. Press **DISPLAY**.
2. Press the **Scale Value** soft key to select ON or OFF.

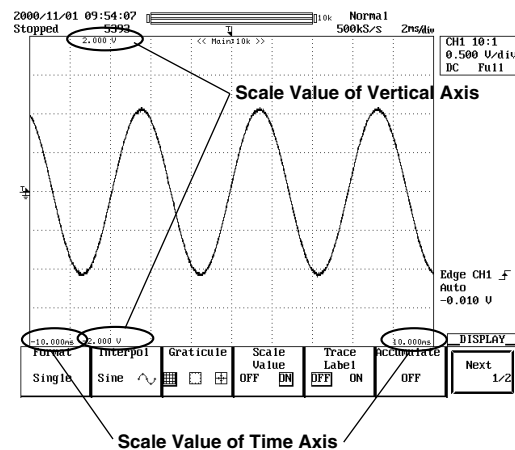
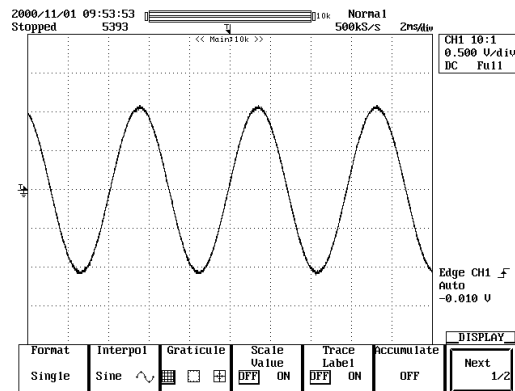

Explanation

You can display the upper and lower limits of the vertical axis or the axis horizontal of each channel.

8.5 Setting the Waveform Labels

<For a description of this function, see page 1-18>

Relevant Keys

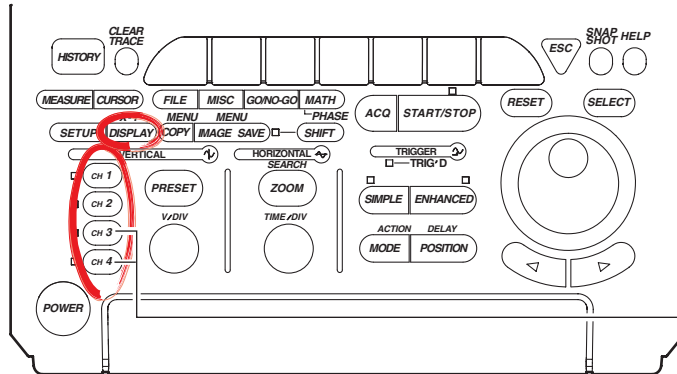

The DL1620 is not equipped with channels 3 and 4.

Operating Procedure

Setting the Waveform Label

1. Press one of the keys from **CH 1** to **CH 4** (or **CH1** to **CH2** for the DL1620) to select the desired channel.
2. Press the **Next 1/2** soft key to display the Next 2/2 menu.

Display	Position	Coupling	Probe	Offset	Bandwidth	CH1
OFF	0.004iv	DC1KHz	10:1	0.0 V	Full	Next 1/2

3. Press the **Label** soft key to display a keyboard, and enter the waveform label according to the procedures described in section 4.1.

Variable	Linear SCI	Label	CH1
50.0 V	PK+B DFF ON	CH1	Next 2/2

8.5 Setting the Waveform Labels

Turning ON/OFF the Waveform Label

4. Press **DISPLAY**.
5. Press the **Trace Label** soft key to select ON or OFF.

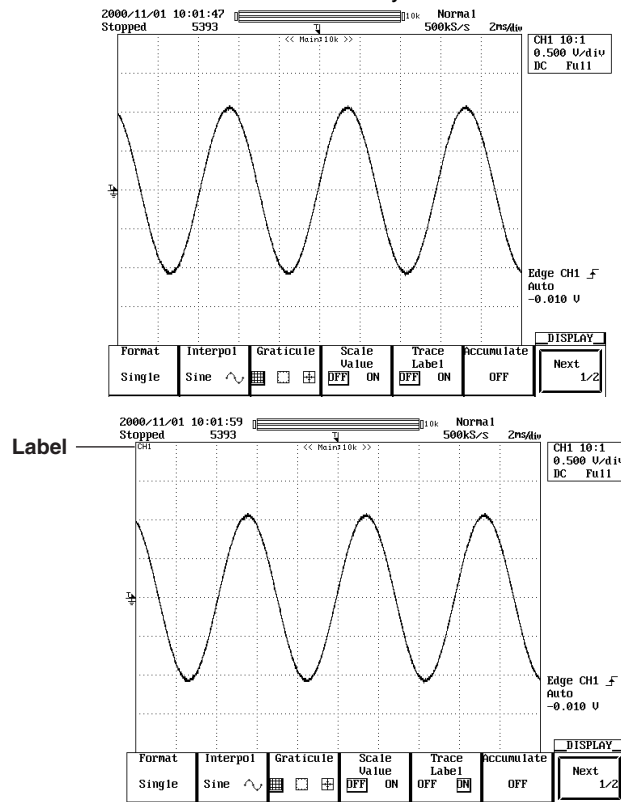

Explanation

Label Display ON/OFF (Trace Label)

Use this parameter to select whether or not to include waveform labels (channel identification labels) on the display.

Entering Customized Labels

You can use the Define Label feature to enter customized labels for each channel. Each label is a character string of up to eight alphanumeric characters. You can set the label display ON/OFF using the Trace Label function; the label appears in the scale-value display and with measurement results.

8.6 Accumulated Waveform Display

<For a description of this function, see page 1-16>

Relevant Keys

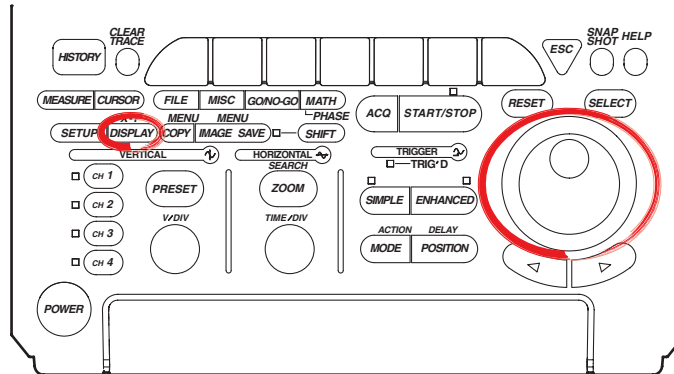

Operating Procedure

Selecting Averaging Mode

1. Press **DISPLAY**.
2. Press the **Accumulate** soft key to display the accumulate mode menu.

Format	Interpol	Graticule	Scale Value	Trace Label	Accumulate	DISPLAY
Quad	Sine		OFF ON	OFF ON	OFF	Next 1/2

3. Press the corresponding to the desired accumulate mode.

Format	Interpol	Graticule	Scale Value	OFF	Persist	Color
Quad	Sine		OFF ON			

Proceed to step 4 if you have selected Persist, or to step 5 if you selected Color.

Setting the Accumulative Time (When Persist has been Selected)

4. Turn the jog shuttle to set the desired accumulative time.

Format	Interpol	Graticule	Scale Value	Trace Label	Accumulate	DISPLAY
Quad	Sine		OFF ON	OFF ON	Persist Time 100ms	Next 1/2

Setting the Grade Width (When Color has been Selected)

5. Turn the jog shuttle to set the desired color width.

Format	Interpol	Graticule	Scale Value	Trace Label	Accumulate	DISPLAY
Quad	Sine		OFF ON	OFF ON	Color Grade 16	Next 1/2

Explanation

During normal operation, the display is updated every time the trigger is activated making it difficult to capture transient conditions such as sudden distortion of waveforms. By using the accumulate function, the waveform display of the acquired data remains on the screen for the specified time.

Accumulate Mode

Persist: Accumulate using each channel color. Displayed for the specified time period by gradually lowering the brightness.

Color: Accumulate using eight colors that indicate the frequency of waveforms in the data.

Accumulation Period (During Persist Mode)

When using the persistence mode, select the period over which waveforms are accumulated from the list below. If you select infinite, the accumulation is carried out infinitely. The default value is 100 ms.

100 ms, 200 ms, 500 ms, 1 s, 2 s, 5 s, 10 s, 20 s, 50 s, and Infinite

Grade Width (for Color Grade Mode)

In color grade mode, the frequency of data value occurrence is indicated in eight colors as illustrated below. The grade width can be set within the range given below. The default setting is 16.

Overlapping display is performed indefinitely in color grade mode.

2 to 2048 (steps of 2ⁿ)

Higher Frequency

Red	28 or more	Red	896 or more
Pink	24 to 27	Pink	768 to 895
Orange	20 to 23	Orange	640 to 767
Yellow	16 to 19	Yellow	512 to 639
White	12 to 15	White	384 to 511
Cyan	8 to 11	Cyan	256 to 383
Green	4 to 7	Green	128 to 255
Blue	1 to 3	Blue	1 to 127
Black	0	Black	0

When Grade Width = 4

When Grade Width = 128

For example, a dot which has appeared on the screen 100 times is displayed in red if the grade width is 4, or in blue if the grade width is 128.

Points for Attention

- Automatic measurement of waveform parameters and GO/NO-GO judgment are performed on the latest waveform.
- When displaying all waveforms in the history memory during accumulation, the historical waveforms are displayed using the specified accumulation mode. However the waveform display becomes slow.
- When printing accumulated waveforms using the optional built-in printer, they are printed using two tones.
- Only the latest waveform can be output to an external printer.
- If the waveform acquisition is forcibly stopped by pressing **START/STOP**, the accumulation is temporarily suspended. When the acquisition is restarted, the display is cleared and accumulation continues.

Clearing Accumulated Waveforms

You can clear accumulated waveforms by pressing **CLEAR TRACE**.

8.7 Turning the Translucent Mode ON/OFF

Relevant Keys

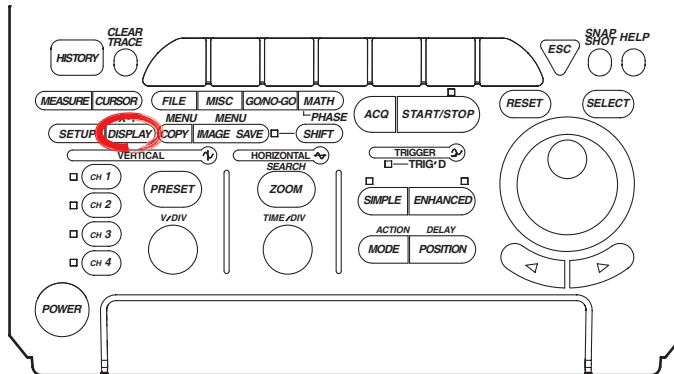

Operating Procedure

1. Press **DISPLAY**.
2. Press the **Next 1/2** soft key to display the Next 2/2 menu.

Format	Interpol	Graticule	Scale Value	Trace Label	Accumulate	DISPLAY
Dual	Sine	<input type="checkbox"/>	OFF ON	OFF ON	OFF	Next 1/2

3. Press the **Translucent** soft key to select ON or OFF.

Translucent	Mapping					DISPLAY
OFF ON	Auto					Next 2/2

Explanation

When this is turned to ON, the pop-up menu becomes translucent. The contents underneath the pop-up menu can be seen.

Translucent: OFF

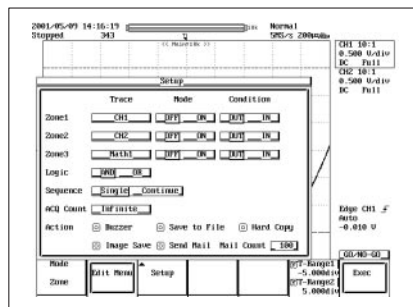

Translucent: ON

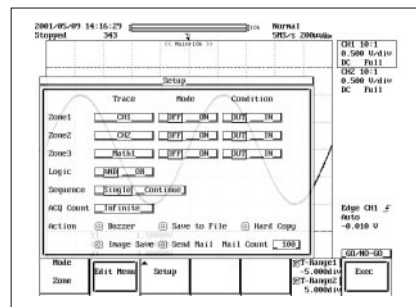

8.8 X-Y Waveform Display

<For a description of this function, see page 1-19>

Relevant Keys

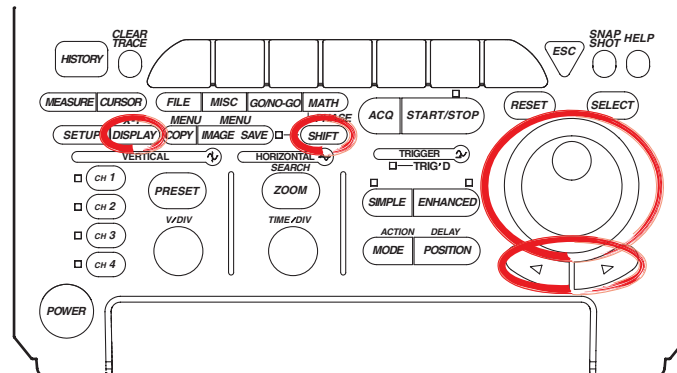

Operating Procedure

1. Press **SHIFT** to activate shift mode.
Functions marked in purple on the panel become active.
2. Press **DISPLAY**.

Selecting the Display Format

3. Press the **Mode** soft key to display the mode selection menu.

Mode						X-Y
T-Y						

4. Press the **T-Y**, **X-Y**, or **T-Y & X-Y** soft key to set the mode.

T-Y	X-Y	T-Y & X-Y				X-Y
-----	-----	-----------	--	--	--	-----

Continue with steps 5 - 12 below if you selected X-Y or T-Y&X-Y.

5. Press the **Select** soft key to select the X-Y waveform that you want to set (DL1640/DL1640L only.)

Setting the X and Y Axes

6. Pressing the **Source** soft key displays the channel menu.
7. Press the soft keys corresponding to the channels that you want to assign to the X and Y axes. If you select None, X-Y waveforms are not displayed.

Mode						X-Y
X-Y	None	X:Ch1 Y:Ch2	X:Ch2 Y:Ch1			T-Range1 -5.000div
						T-Range2 5.000div

Setting the Display Range

8. Press the **T-Range1/T-Range2** soft key.
Turn the jog shuttle to set the display T-Range1.
9. In a similar fashion, press the **T-Range1/T-Range2** soft key to set the display T-Range-2.

Setting the Split View (DL1640/DL1640L only)

10. Press the **Split** soft key and select ON or OFF to separate the display of the XY1 and XY2 waveforms.

Mode	Select	Source	Split			X-Y
T-Y & X-Y	XY1 XY2	X:Ch1 Y:Ch2	OFF ON			T-Range1 -5.000div
						T-Range2 5.000div

Explanation**Assigning X (Horizontal) and Y (Vertical) Axes: Source**

The channels that can be assigned to the X and Y axes are as follows:

X-Y waveform	X axis, Y axis		
XY1	X: CH1 Y: CH2	or	X: CH2 Y: CH1
XY2 (DL1640/DL1640L) ^{or}	X: CH3 Y: CH4		X: CH4 Y: CH3
None	X-Y waveforms are not displayed		

Number of X-Y Waveforms that can be Displayed

The number of X-Y waveforms that can be displayed is two (XY1, XY2), (or one (XY1) for the DL1620) . The display of each X-Y waveform can be turned ON/OFF.

Selecting the Display Format: Mode

You can choose from the following three display formats.

T-Y&X-Y: The top window displays normal (T-Y) waveforms. The bottom window displays X-Y waveforms.

X-Y: Displays only X-Y waveforms.

T-Y: Displays only T-Y waveforms.

Selecting the X-Y Waveform Display Range: T-Range1/T-Range2

The X-Y display shows the range selected on the T-Y waveform.

You can set the start (fine dashed line) and end (coarse dashed line) positions in the range -5 to +5 div from the center of the waveform display frame. The start and end positions are not displayed on the X-Y waveform.

The resolution is as follows.

Resolution: T/div × 10/displayed record length

Selecting the Split View: Split (DL1640/DL1640L only)

If this setting is ON, the XY1 and XY2 waveforms are displayed in separate windows. Further, even if Mode is X-Y, T-Y waveforms are displayed.

Precautions to be Taken when Displaying X-Y Waveforms

- The divided windows of the T-Y waveform display when using the T-Y & X-Y format are displayed in accordance with the Format setting specified with **DISPLAY**.
- The zoom function applies only to T-Y waveforms. In addition, Main, Z1, or Z2 can be selected for the T-Y waveform display.
- When expanding the X-Y waveform, change the Variable parameter of each channel. The waveform can be expanded or reduced artificially.
- In the modes below, the waveform may flicker when using the T-Y&X-Y display. If the waveform flickers, change to just the X-Y or T-Y display.
 - High Resolution mode
 - Averaging mode
 - Repetitive Sampling mode

8.9 Zooming the Waveform

<For a description of this function, see page 1-19>

Relevant Keys

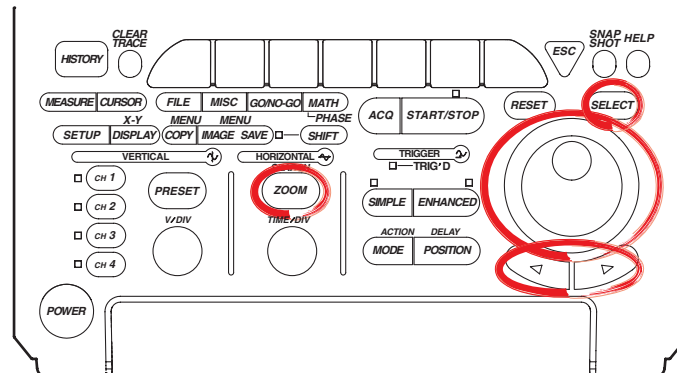

Operating Procedure

Selecting the Display Mode

1. Press **ZOOM**.
2. Pressing the **Mode** soft key displays the display format menu.

Mode						ZOOM
Main						

3. Press the soft key corresponding to the desired display format.

Main	Z1 Only	Z2 Only	Main&Z1	Main&Z2	Z1&Z2	Main&Z1&Z2
------	---------	---------	---------	---------	-------	------------

Setting the Zoom Rate

4. Press the **Z1 Mag/Z2 Mag** soft key.
Turn the jog shuttle to set the zoom rate of Z1 zoom box (If you set Mode to Z1, Z1 Mag is displayed. If you select Z2, Z2 Mag is displayed. If you select Z1 and Z2, Z1 Mag/Z2 Mag is displayed.).

Mode	Z1 Mag	Z1 Pos	Fit Meas	Fit Meas	Fit X-Y	Fit X-Y	ZOOM
Main&Z1&Z2	x 2	1.000div	Ring to Z1	Ring to Z2	Ring to Z1	Ring to Z2	
	Z2 Mag	Z2 Pos					
	x 2	1.000div					

5. In a similar fashion, press the **Z2 Mag** soft key to set the zoom rate of Z2 zoom box.

Selecting the Zoom Position

6. Press the **Z1 Pos/Z2 Pos** soft key. (If you set Mode to Z1, Z1 Pos is displayed. If you select Z2, Z2 Pos is displayed. If you select Z1 and Z2, Z1 Pos/Z2 Pos is displayed.)

Turn the jog shuttle to set the zoom position of the Z1 zoom box.

Mode	Z1 Mag	Z1 Pos	Fit Meas	Fit Meas	Fit X-Y	Fit X-Y	ZOOM
Main&Z1&Z2	x 2	1.000div	Ring to Z1	Ring to Z2	Ring to Z1	Ring to Z2	
	Z2 Mag	Z2 Pos					
	x 2	1.000div					

7. In a similar fashion, press the **Z2 Pos** soft key to set the zoom position of Z2 zoom box.

By setting the jog shuttle control to both Z1 Pos and Z2 Pos, the zoom positions of both Z1 and Z2 can be moved simultaneously.

Changing the Range of the Automated Measurement of Waveform Parameters

8. Press the **Fit Meas Rng to Z1** or **Fit Meas Rng to Z2** soft key (depending on the display format of the zoom waveform) to set the range of the automated measurement of waveform parameters to the zoom range of Z1 or Z2, respectively.

Changing the Range of the X-Y Waveform Display

9. Pressing the **Fit X-Y Rng to Z1** or **Fit X-Y Rng to Z2** soft key (depending on the zoomed waveform display format), sets the X-Y display range to the Z1 or Z2 zoom range.

Explanation

The zoomed waveform of two locations can be displayed simultaneously (dual zoom). Note that if the number of displayed points is less than or equal to 50 (or 40), zooming is not possible.

Selecting the Display Mode of Zoomed Waveforms: Mode

Main: Displays only the main (unzoomed) waveform.

Z1 Only: Displays only the zoomed waveform of zoom box Z1.

Z2 Only: Displays only the zoomed waveform of zoom box Z2.

Main&Z1: Displays the main waveform in the top window and zoomed waveform of zoom box 1 in the bottom window.

Main&Z2: Displays the main waveform in the top window and zoomed waveform of zoom box 2 in the bottom window.

Z1&Z2: Displays the zoomed waveform of zoom box 1 in the top window and the zoomed waveform of zoom box 2 in the bottom window.

Main&Z1&Z2: Displays the main waveform in the top window, the zoomed waveform of zoom box 1 in the lower left window and the zoomed waveform of zoom box 2 in the lower right window.

Zoom Rate: Z1 Mag/Z2 Mag

- The maximum zoom rate varies depending on the displayed record length.
Maximum zoom rate: $(\text{displayed record length})/50$ (or 40)
Note that the displayed record length is not necessarily the same as the record length of the acquisition memory.
For details regarding the displayed record length, see Appendix 1, "Relationship between the Time Axis Setting, Sample Rate, and Record length."
- You can change the zoom rate for Z1 and Z2 (zoomed waveforms of two locations).

Zoom Position: Z1 Position and Z2 Position

- The zoom position can be set by specifying the center position in the range -5 to $+5$ div from the center of the waveform display frame.
The resolution is as follows.
Zoom position resolution: $(T/\text{div} \times 10)/(\text{displayed record length})$
- The zoom box enclosed by solid lines is Z1 and the one enclosed by dashed lines is Z2. Since each box is independent, you can set the position separately.

8.9 Zooming the Waveform

Changing the Range of the Automated Measurement of Waveform Parameters: Fit Meas Rng to Z1/Fit Meas Rng to Z2

Sets the range of the automated measurement of waveform parameters to the zoom range of Z1 or Z2. This is valid even if the automated measurement of waveform parameters is turned OFF.

Changing the Range of the X-Y Waveform Display: Fit X-Y Rng to Z1/Fit X-Y Rng to Z2

The X-Y waveform display range can be fitted to match the Z1 or Z2 zoom range. This setting is effective even when X-Y Mode is T-Y.

Zooming the Power Spectrum

It is not possible to zoom a power spectrum of 1 k FFT points. A power spectrum with 10 k FFT points can be zoomed to a maximum of 10x.

8.10 Search Data Using Search and Zoom Function

<For a description of this function, see page 1-26>

Relevant Keys

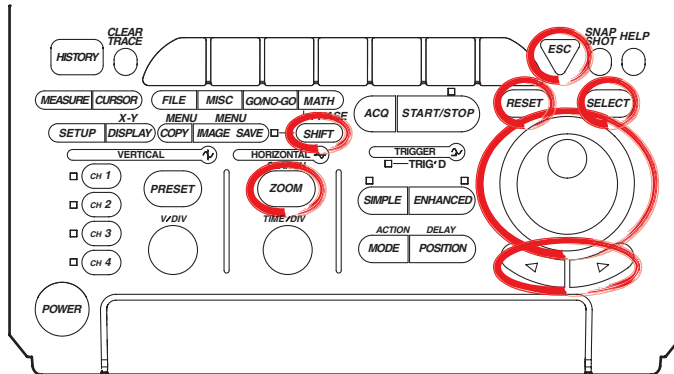

Operating Procedure When Performing a Edge Search

1. Press **SHIFT** to activate shift mode.
Functions marked in purple on the panel become active.
2. Press **ZOOM**.

Selecting the Search Method (Type)

3. Pressing the **Type** soft key displays the search method menu.

Type	Setup	21 Hag	21 Pos	Searched Pattern	SEARCH
Edge		x 2	0.000iu	No Match	Exec

4. Press the **Edge** soft key.

Edge	Serial Pattern	Width	Parallel Pattern	Auto Scroll	Searched Pattern	SEARCH
					No Match	Exec

Setting the Search Condition

5. Pressing the **Setup** soft key displays the search condition setting dialog box. Turn the jog shuttle to select the parameter. Pressing **SELECT** displays a menu used to set the item or changes the selected item.

Setup

Source: CH1

Level: 0.000 V

Polarity: [+]

Hysteresis: 0.3diu

Count: 1

Start Point: -5.000diu

Settings for these items can be input directly using a USB keyboard. (Ⓜ)

Type	Setup	21 Hag	21 Pos	Searched Pattern	SEARCH
Edge		x 2	0.000iu	No Match	Exec

8.10 Search Data Using Search and Zoom Function

• Setting the Source

- Turn the jog shuttle to move the cursor to the channel to be searched and press **SELECT**. (CH3, CH4, and Math2 are not displayed on the DL1620).

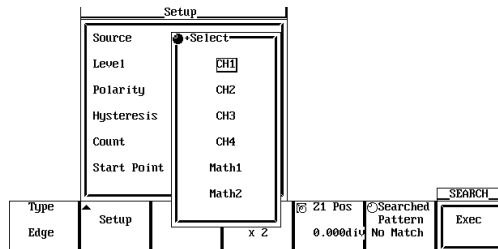

• Setting the Level

- Turn the jog shuttle to set the level and press **SELECT**. You can use the arrow keys to move between the digits. Pressing **RESET** resets the level to 0 V.

• Setting the Polarity

- Press **SELECT** to select f or \bar{f} .

• Setting the Hysteresis

- Turn the jog shuttle to set the hysteresis and press **SELECT**. You can use the arrow keys to move between the digits. Pressing **RESET** resets the hysteresis to 0.3 div.

• Setting the Count

- Turn the jog shuttle to set the count and press **SELECT**. You can use the arrow keys to move between the digits. Pressing **RESET** resets the count to 0.

• Setting the Start Point

- Turn the jog shuttle to set the start position of the search. Press **SELECT**. You can use the arrow keys to move between the digits. Pressing **RESET** sets the position to -5 div.
- Press **ESC** to close the search condition setting dialog box.

Setting the Display Position of the Search Results (When Zoom Mode is Z1 & Z2 or Main & Z1 & Z2)

- Press the **Result Window** soft key to select Z1 or Z2.

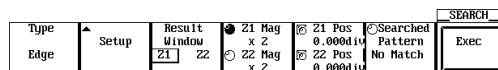

Executing the Search

- Pressing the **Exec** soft key starts the search. The search results are displayed in the zoomed waveform display position selected in step 13. You can search 1000 times using the same conditions.

Displaying the Previous Search Results

- Press the **Searched Pattern** soft key.
- Turn the jog shuttle to select the number of the search result to be displayed. Newer search results are displayed with higher numbers (result 2 is newer than result 1).

Changing the Zoom Rate and Position

17. As in the zoomed waveform, you can change the zoom rate of Z1 and Z2 by pressing the **Z1 Mag/Z2 Mag** soft key and turning the jog shuttle.
18. As in the zoomed waveform, you can move the section that is being zoomed by pressing the **Z1 Pos/Z2 Pos** soft key and turning the jog shuttle.

When Performing a Serial Pattern Search

1. Press **SHIFT** to activate shift mode.
Functions marked in purple on the panel become active.
2. Press **ZOOM**.

Selecting the Search Method (Type)

3. Pressing the **Type** soft key displays the search method menu.

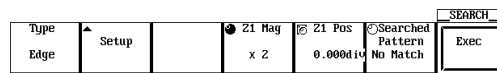

4. Press the **Serial Pattern** soft key.

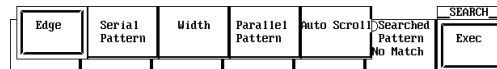

Setting the Search Conditions

5. Pressing the **Setup** soft key displays the search condition setting dialog box. Turn the jog shuttle to select the parameter. Pressing **SELECT** displays a menu used to set the item or changes the selected item.

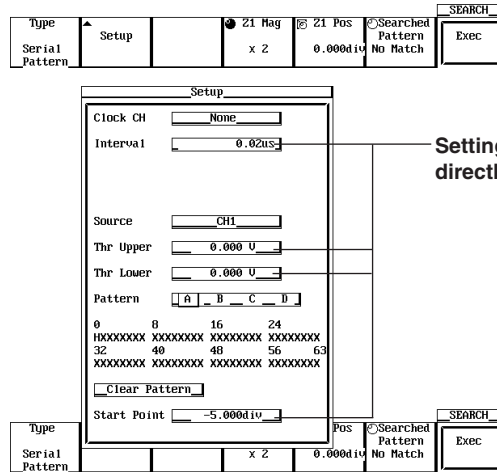

8.10 Search Data Using Search and Zoom Function

- **Setting the Clock CH**

6. Turn the jog shuttle to move the cursor to the clock channel and press **SELECT**. If you selected CH1 to CH4 (or CH1 to CH2 on the DL1620), go to step 7. If you selected None, go to step 10.

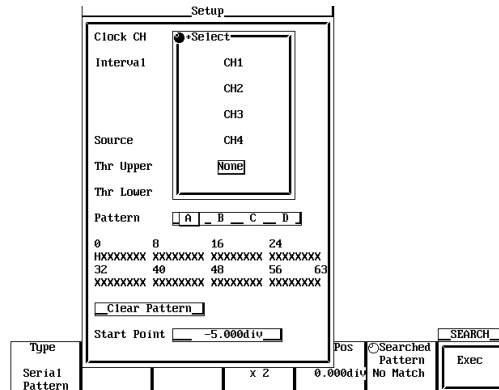

- **Setting the Level (When Clock CH is Set to CH1-CH4)**

7. Turn the jog shuttle to set the level and press **SELECT**. You can use the arrow keys to move between the digits. Pressing **RESET** resets the level to 0 V.

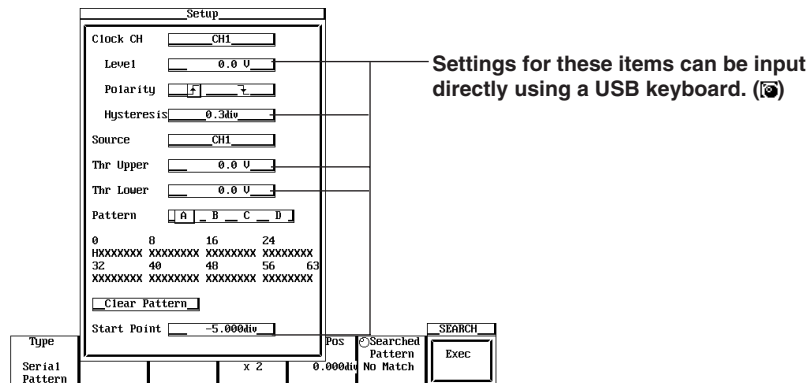

- **Setting the Polarity (When Clock CH is Set to CH1-CH4)**

8. Press **SELECT** to select f or \bar{f} .

- **Setting the Hysteresis (When Clock CH is Set to CH1-CH4)**

9. Turn the jog shuttle to set the hysteresis and press **SELECT**. You can use the arrow keys to move between the digits. Pressing **RESET** resets the hysteresis to 0.3 div.

- **Setting the Interval (When Clock CH is Set to None)**

10. Turn the jog shuttle to set the interval at which to check the pattern and press **SELECT**. You can use the arrow keys to move between the digits. Pressing **RESET** resets the interval to the default value.

• **Setting the Source**

- Turn the jog shuttle to move the cursor to the channel to be searched and press **SELECT**. (CH3, CH4, and Math2 are not displayed on the DL1620).

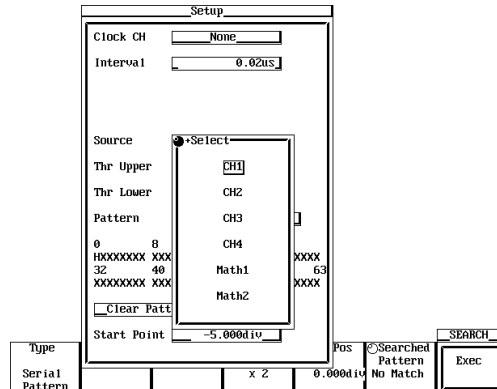

• **Set the Thr Upper**

- Turn the jog shuttle to set the level used to determine Low and press **SELECT**. You can use the arrow keys to move between the digits. Pressing **RESET** resets the level to 0 V.

• **Set the Thr Lower**

- Turn the jog shuttle to set the level used to determine High and press **SELECT**. You can use the arrow keys to move between the digits. Pressing **RESET** resets the level to 0 V.

• **Set the Pattern**

- Press **SELECT** to select the pattern number A to D.
- Turn the jog shuttle to move the cursor to the desired bit position.
- Press **SELECT** to select H, L, or X. If you click Clear Pattern all bits are set to X.
- Set other pattern numbers as necessary.

• **Setting the Start Point**

- Turn the jog shuttle to set the start position of the search. Press **SELECT**. You can use the arrow keys to move between the digits. Pressing **RESET** sets the position to -5 div.
- Press **ESC** close the search condition setting dialog box.

Setting the Display Position of the Search Results (When Zoom Mode is Z1 & Z2 or Main & Z1 & Z2)

- Press the **Result Window** soft key to select Z1 or Z2.

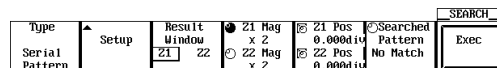

Executing the Search

- Pressing the **Exec** soft key starts the search. The search results are displayed in the zoomed waveform display position selected in step 17. You can search 1000 times using the same conditions.

8.10 Search Data Using Search and Zoom Function

Displaying the Previous Search Results

22. Press the **Searched Pattern** soft key.
23. Turn the jog shuttle to select the number of the search result to be displayed.
Newer search results are displayed with higher numbers (result 2 is newer than result 1)

Changing the Zoom Rate and Position

24. As in the zoomed waveform, you can change the zoom rate of Z1 and Z2 by pressing the **Z1 Mag/Z2 Mag** soft key and turning the jog shuttle.
25. As in the zoomed waveform, you can move the section that is being zoomed by pressing the **Z1 Pos/Z2 Pos** soft key and turning the jog shuttle.

When Performing a Parallel Pattern Search

1. Press **SHIFT** to activate shift mode.
The functions printed in purple letters on the front panel become activated.
2. Press **ZOOM**.

Selecting the Search Method Type

3. Press the **Type** soft key to display the search method selection menu.

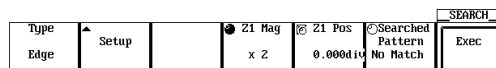

4. Press the **Parallel Pattern** soft key.

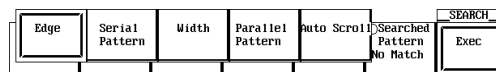

Setting the Search Criteria

5. Press the **Setup** soft key to display the search criteria settings dialog box. Turn the jog shuttle to select the setting item. When you press **SELECT**, the settings menu for the selected item is displayed, or the selected value is changed.

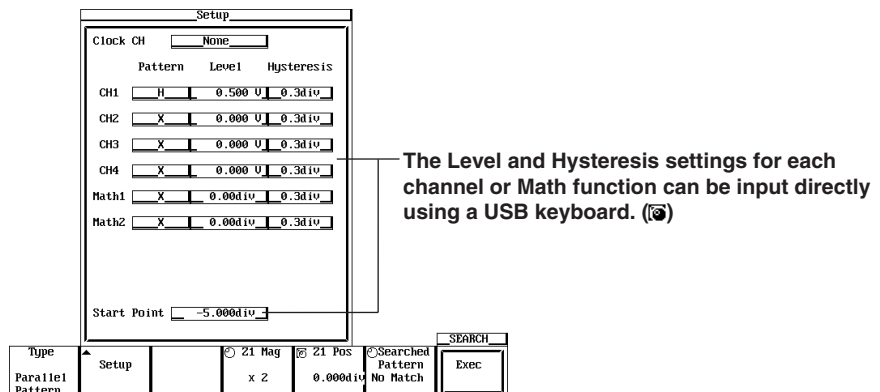

- **Setting the Clock CH**

6. Move the cursor over to the clock channel with the jog shuttle, then press **SELECT**. When selecting CH1-CH4 (or CH1 to CH2 on the DL1620), proceed to step 7. If you select None, skip to step 10.

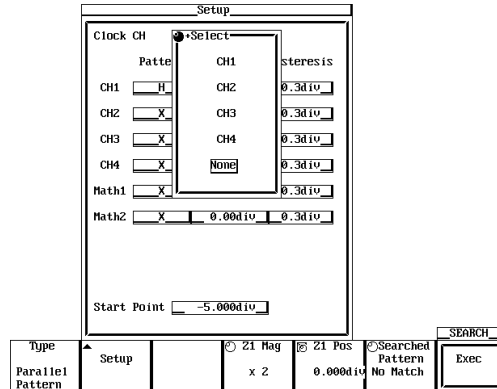

- **Setting the Clock Channel Pattern**

7. Use the jog shuttle to move the cursor to the Pattern of the channel set as the clock channel. Press **SELECT** to select or .

- **Setting the Clock CH Level**

8. Use the jog shuttle to move the cursor to the Level of the channel set as the clock channel. Press **SELECT**, then use the jog shuttle to set the level, and press **SELECT** again. Use the arrow keys to move between the digits. If you press **RESET**, the setting will be restored to 0 V.

- **Setting the Hysteresis of the Clock Channel**

9. Use the jog shuttle to move the cursor to the Hysteresis of the channel set as the clock channel. Press **SELECT**, use the jog shuttle to set the hysteresis, then press **SELECT** again. Use the arrow keys to move between the digits. If you press **RESET**, the setting will be restored to 0.3 div.

- **Setting the Pattern for Each Channel**

10. Use the jog shuttle to move the cursor to the Pattern of the channel you wish to set. Press **SELECT** key to select H, L, or X.

- **Setting the Level for Each Channel**

11. Use the jog shuttle to move the cursor to the Level of the channel you wish to set. Press **SELECT**, then use the jog shuttle to set the Level and press **SELECT** again. Use the arrow keys to move between the digits. If you press **RESET**, the setting will be restored to 0 V.

- **Setting the Hysteresis for Each Channel**

12. Use the jog shuttle to move the cursor to the Hysteresis of the channel you wish to set. Press **SELECT**, then use the jog shuttle to set the hysteresis, and press **SELECT** again. Use the arrow keys to move between the digits. If you press **RESET**, the setting will be restored to 0.3 div.

- **Setting the Start Point**

13. Use the jog shuttle to move the cursor to the start point, then press **SELECT**. Use the jog shuttle to select the start point, then press **SELECT** again. Use the arrow keys to move between the digits. If you press **RESET**, the setting will be restored to -5 div.
14. Press **ESC** to close the dialog box.

8.10 Search Data Using Search and Zoom Function

Setting the Display Position for the Search Results (When Zoom Mode is Z1&Z2 or Main&Z1&Z2)

15. Press the **Results Window** soft key to select Z1 or Z2.

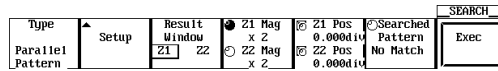

Executing the Search

16. Press the **Exec** soft key to perform the search. The results are displayed in the zoom waveform display position selected in step 15. You can perform a search using the same search criteria 1000 times.

Displaying Previous Search Results

17. Press the **Searched Pattern** soft key to highlight the jog shuttle icon.
18. Turn the jog shuttle to select the number of the search results to be displayed. The most recent search has the highest number.

Changing the Zooming Factor and Position

19. As you did with the zoomed waveform, press the **Z1 Mag/Z2 Mag** soft key, then turn the jog shuttle to change the zooming factor of Z1 and Z2.
20. As you did with the zoomed waveform, press the **Z1 Pos/Z2 Pos** soft key, then turn the jog shuttle to change the position of the zoom box for Z1 and Z2.

When Performing a Pulse Width Search

1. Press **SHIFT** to activate shift mode. The functions printed in purple letters on the front panel become activated.
2. Press **ZOOM**.

Selecting the Search Method

3. Press the **Type** soft key to display the search method selection menu.

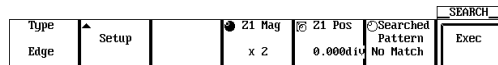

4. Press the **Width** soft key to select the search method.

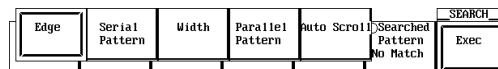

Setting the Search Criteria

5. When you press the **Setup** soft key the search criteria settings dialog box is displayed. Turn the jog shuttle to select a setting item. Press **SELECT** to display the setting menu for the selected item, or change the current setting.

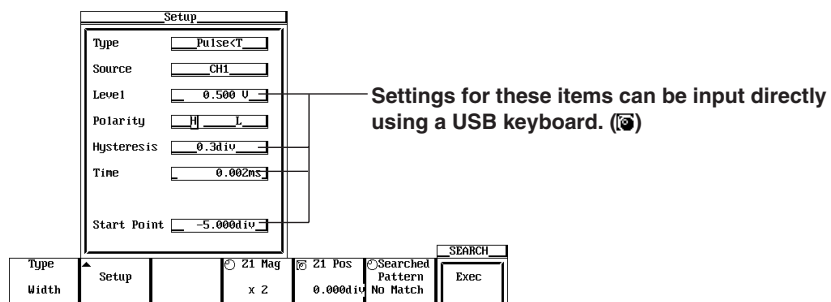

- **Setting the Type**

6. Use the jog shuttle to choose either Pulse < T, Pulse > T, T1 < PLS < T2, T1 < PLS < T2, or Time Out, then press **SELECT**.

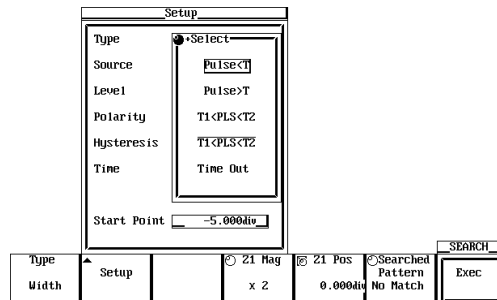

- **Setting the Source**

7. Use the jog shuttle to move the cursor to the desired source channel then press **SELECT**. (CH3, CH4, and Math2 are not displayed on the DL1620).

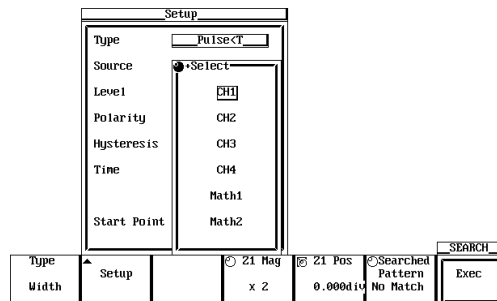

- **Setting the Level**

8. Use the jog shuttle to set the level, then press **SELECT**. Use the arrows to move between the digits. Pressing **RESET** restores the value to 0 V.

- **Setting the Polarity**

9. Press **SELECT** to select H or L.

- **Setting the Hysteresis**

10. Use the jog shuttle to set the hysteresis, then press **SELECT**. Use the arrow keys to move the arrows between the digits. Pressing **RESET** restores the value to 0.3 div.

- **Setting the Time**

11. Use the jog shuttle to set the count, then press **SELECT**. Use the arrow keys to move the arrows between the digits. Pressing **RESET** restores the value to minimum resolution (1/sample rate). Set Time1 and Time2 if you selected T1 < PLS < T2 or T1 < PLS < T2 in step 6.

- **Setting the Start Point**

12. Use the jog shuttle to set the search start position, then press **SELECT**. Use the arrow keys to move the arrows between the digits. Pressing **RESET** restores the value to -5 div.
13. Press **ESC** to close the dialog box.

8.10 Search Data Using Search and Zoom Function

Setting the Search Results Display Position (When Zoom Mode is Z1&Z2 or Main&Z1&Z2)

14. Press the **Result Window** soft key to select Z1 or Z2.

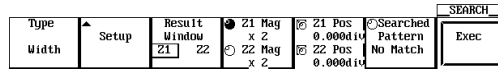

Executing the Search

15. Press the **Exec** soft key to perform the search. The search results are displayed in the zoom waveform display position selected in step 14.
You can search 1000 times using the same conditions.

Displaying Previous Search Results

16. Press the **Searched Pattern** soft key to highlight the jog shuttle icon.
17. Turn the jog shuttle to select one of the displayed search results numbers. The higher the number the more recent the search result.

When Performing an Auto Scroll Search

1. Press **SHIFT** to activate the shift mode.
2. Press **ZOOM**.

Selecting the Search Method (Type)

3. Press the **Type** soft key to display the search method selection menu.

Type	Setup	Z1 Mag	Z1 Pos	Searched Pattern	SEARCH
Edge		x 2	0.000div	No Match	Exec

4. Press the **Auto Scroll** soft key.

Edge	Serial Pattern	Width	Parallel Pattern	Auto Scroll	Searched Pattern	SEARCH
					No Match	Exec

Selecting the Scroll Direction

5. Press the **Direction** soft key to set the scrolling direction.

Type	Direction	Result Window	Z1 Mag	Z1 Pos	Speed	SEARCH
Auto Scroll	<< >>	Z1 Z2	x 2.5	0.000div	4	Exec
			x 2.5	0.000div		

Setting the Search Results Display Position (When Zoom Mode is Z1&Z2 or Main&Z1&Z2)

6. Press the **Results Window** soft key to select Z1 or Z2.

Type	Direction	Result Window	Z1 Mag	Z1 Pos	Speed	SEARCH
Auto Scroll	<< >>	Z1 Z2	x 2.5	0.000div	4	Exec
			x 2.5	0.000div		

Changing the Zooming Factor and Position

7. As you did with the zoomed waveform, press the **Z1 Mag/Z2 Mag** soft key, then turn the jog shuttle to change the part which is expanded and displayed in Z1 and Z2.
8. As you did with the zoomed waveform, press the **Z1 Pos/Z2 Pos** soft key, then turn the jog shuttle to change the part which is expanded and displayed in Z1 and Z2.

Setting the Scroll Speed

9. Press the **Speed** soft key, then use the jog shuttle to set the scroll speed from 1 to 7.

Executing the Scroll

10. Press the **Exec** soft key to perform the Scroll. Press the key again to stop the Scroll.

Explanation

When the data acquisition is stopped, a section of the waveform can be searched and displayed expanded.

Search Method: Type

The following two search methods are available.

- Edge:** Searches the number of times the signal went above (rising) or below (falling) the specified level from the search start position.
- Serial Pattern:** Searches for a section of the waveform that has the same pattern as the specified waveform pattern (High or Low status or Don't Care).
- Parallel Pattern:** Searches by using a status (High, Low, or Don't Care) of each channel, CH1 through CH4, Math1, and Math2 (or CH1, CH2, and Math1 for the DL1620).
- Pulse Width:** Searches for a particular section of the current displayed waveform. Searches for a section of the waveform of which the pulse width is shorter or longer than the specified time width from the search start position.
- Auto Scroll:** The zoom position automatically moves (auto scroll) in the specified direction. You can scroll through the zoomed waveform and stop the scrolling at the desired position.

Search Condition: Setup

• When the Type is Edge

- Source:** Select the channel to be searched. You can also select Math1 and Math2 (or Math1 for the DL1620).
- Level:** Set the level used to determine the rising or falling edge. The range is 8 div within the screen. The resolution is 0.01 div.
- Polarity:** Select the polarity from the following list.
- ↕: Search by the number of times the waveform passes from below the specified level to above the specified level.
 - ↕: Search by the number of times the waveform passes from above the specified level to below the specified level.
- Hys:** Set the hysteresis. The range is 0.3 div to 4 div.
- Count:** Set the number of times ↕ or ↕ is to be met. The range is 1 to 1000000.
- Start Point:** Set the starting position of the search. The range is from -5 to 5 div.

• When the Type is Serial Pattern

- Clock CH:** Select the clock channel, from CH1 to CH4 (or CH1 to CH2 for the DL1620), that is used as a timing reference in searching the status. When None is selected, the status is searched at a predetermined interval.
- Source:** Select the channel to be searched. You can also select Math1 and Math2 (or Math1 for the DL1620).
- Thr Upper:** Set the level used to determine Low (L).
- Thr Lower:** Set the level used to determine High (H).
- Pattern:** Four different types of patterns can be registered. Set the pattern with 64 bits of H, L, X (Don't Care) symbols.
- H: When the value is greater than or equal to Thr Lower.
 - L: When the value is less than or equal to Thr Upper.
 - X: Do not determine.
- Start Point:** Set the start position of the search. The range is from -5 to 5 div.

When CH1 to CH4 (or CH1 to CH2 for the DL1620) is Set as the Clock Channel

Level: Set the level used to determine the rising or falling edge. The range is 8 div within the screen. The resolution is 0.01 div.

Polarity: Select the polarity from the following list.

⌈: Search the status when the waveform changes from below the specified level to above the specified level.

⌋: Search the status when the waveform changes from above the specified level to below the specified level.

Hys: Set the hysteresis. The range is 0.3 div to 4 div.

When None is Set as the Clock Channel

Interval: Set the interval at which to search the status.

- **When the Type is Parallel Pattern**

Clock CH: Select a clock channel from CH1 to CH4 (or CH1 to CH2 for the DL1620) that will provide the standard timing for searching the status. Select NONE to check the status of all the data.

Start Point: Set the starting position for the search. The range for this setting is -5 to 5 div.

Channels Specified as Clock Channels

Level: Set the level for determining rising and falling. The range for the setting is an on-screen 8 div, and the resolution is 0.01 div.

Pattern: Choose from the following:

⌈: Check the pattern when the waveform changes from above to below the specified level.

⌋: Checks the pattern when the waveform changes from below to above the specified level.

Hysteresis: Set the hysteresis. The range for the setting is 0.3 to 4 div.

Channels Other than Clock Channels

Pattern: Set using the H, L, or X (Don't Care) symbols.

H: When the value is greater than the level.

L: When the value is less than the level.

X: Do not determine.

Level: Set the levels to determine H and L.

Hysteresis: Set the hysteresis. The range for this setting is 0.3 div to 4 div.

- **When the Type is Pulse Width**

- Type: Select the relationship between the specified time and the measured waveform.
- Pulse < T: Detects a section of the waveform whose pulse width (Pulse) is shorter than the specified time (T).
- Pulse > T: Detects a section of the waveform whose pulse width (Pulse) is longer than the specified time (T).
- T1 < PLS < T2: Detects a section of the waveform whose pulse width (Pulse) is within the specified times (T1 to T2).
- $\overline{T1 < PLS < T2}$: Detects a section of the waveform whose pulse width (Pulse) is outside the specified times (T1 to T2).
- Timeout: Detects a section of the waveform whose pulse width (Pulse) exceeds the specified time (T). The displayed position in the zoom display differs from the Pulse > T case.
- Source: Select the source channel for the search. You can also select Math1 and Math2 (or Math1 for the DL1620).
- Level: Set the level for determining High and Low. The setting range is an on-screen 8 div, and the resolution is 0.01 div.
- Polarity: Choose from the following:
High: When the waveform is higher than the specified level.
Low: When the waveform is lower than the specified level.
- Hysteresis: Set the hysteresis. The range for this setting is 0.3 div to 4 div.
- Time: Set the determination time, "T." The range for this setting is 1/sample rate display range.
- Start Point: Set the starting position for the search. The range for this setting is -5 to 5 div.

Display Position of the Searched Waveform: Result Window

When the zoom mode is set to Z1 & Z2 or Main & Z1 & Z2, you can select whether to display the searched waveform in the Z1 or Z2 window.

Search Count

The search can be carried out up to 1000 times. When the type is edge, the rising or falling edge is counted from the previous search position. In addition, the past search results can also be displayed.

Changing the Zoom Rate and Position

The search results are displayed in the zoomed waveform display area. As in the zoomed waveform, the zoom rate and position can be changed.

Precautions to be Taken when Searching

- Searching is not possible while the data acquisition is in progress.
- Searching is not possible on the computed results of the power spectrum.
- The search result is void if the following operations, are carried out:
Starting data acquisition.
Changing the Search Setup setting.
Shifting the phase of the source or the clock.
- Searching is not possible when setting CH2 or CH4 as the clock channel while in high-resolution mode.
- Searching is not possible when all patterns are set to X.
- Patterns from undisplayed waveforms will not be referenced during searches.

Determination when Using the Edge for the Search

When the peak immediately after the rising edge of the waveform is less than or equal to the upper limit of the hysteresis or when the peak immediately after the falling edge is greater than or equal to the lower limit of the hysteresis, it is determined as false (not counted as a specified edge).

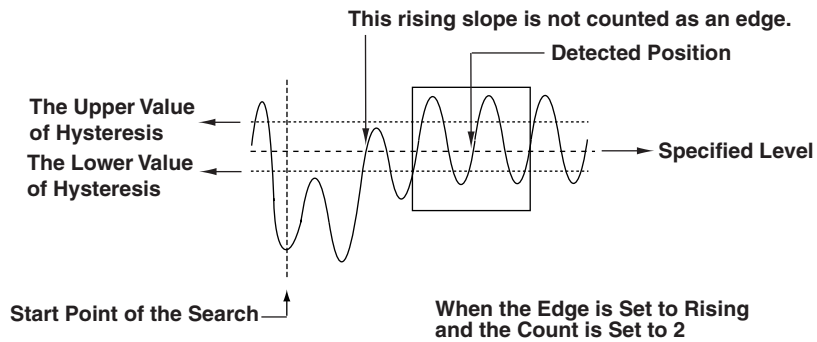

Determination when Searching Using a Serial Pattern

The points between the Thr Upper and Thr Lower are always determined to be true (matches the specified status). If such a point is included at the time the pattern is checked, a message is displayed as a notification.

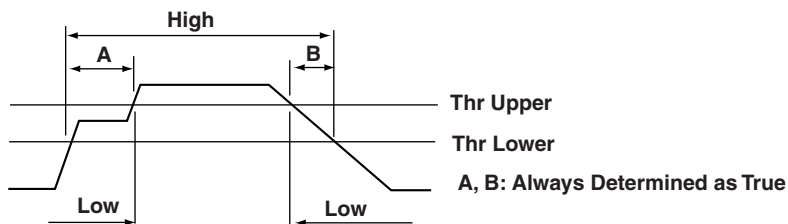

8.10 Search Data Using Search and Zoom Function

Search Start Point when Using a Serial Pattern Search

The search start point is as follows when Clock CH is set to None.

On the screen, the first rising or falling edge to the right of the specified Start Point becomes the reference. The search start point is set to 1/2 the specified interval right of the reference point. However, if the Start Point and the search start point described above are separated by an interval larger than the specified interval, the search start point is set back in units of the specified interval to a point so that the interval between the Start Point and the search start point is within the specified interval. (The search start point must be to the right of the start point in this case.) Within the hysteresis range of Clock CH, the rising or falling edge cannot be checked.

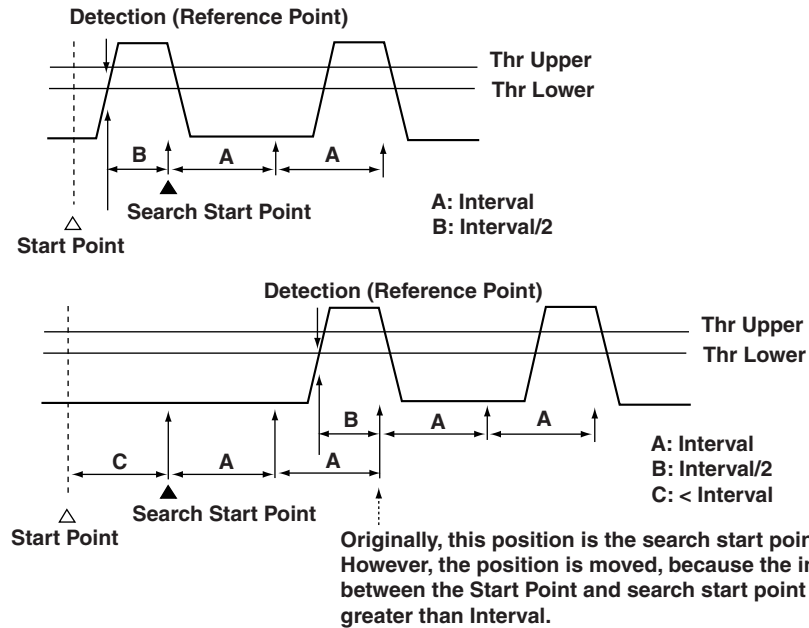

Defermation During a Parallel Pattern Search

The hysteresis points are normally evaluated as true (conforming to the specified status).

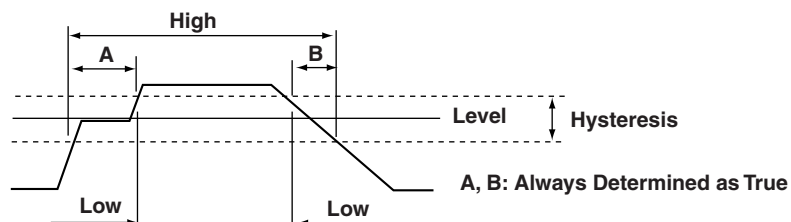

Display Position for Pulse Width Searches

The position of the waveform displayed in the zoom screen will change in the following manner depending on the Type setting: An example in which the polarity is H is shown below.

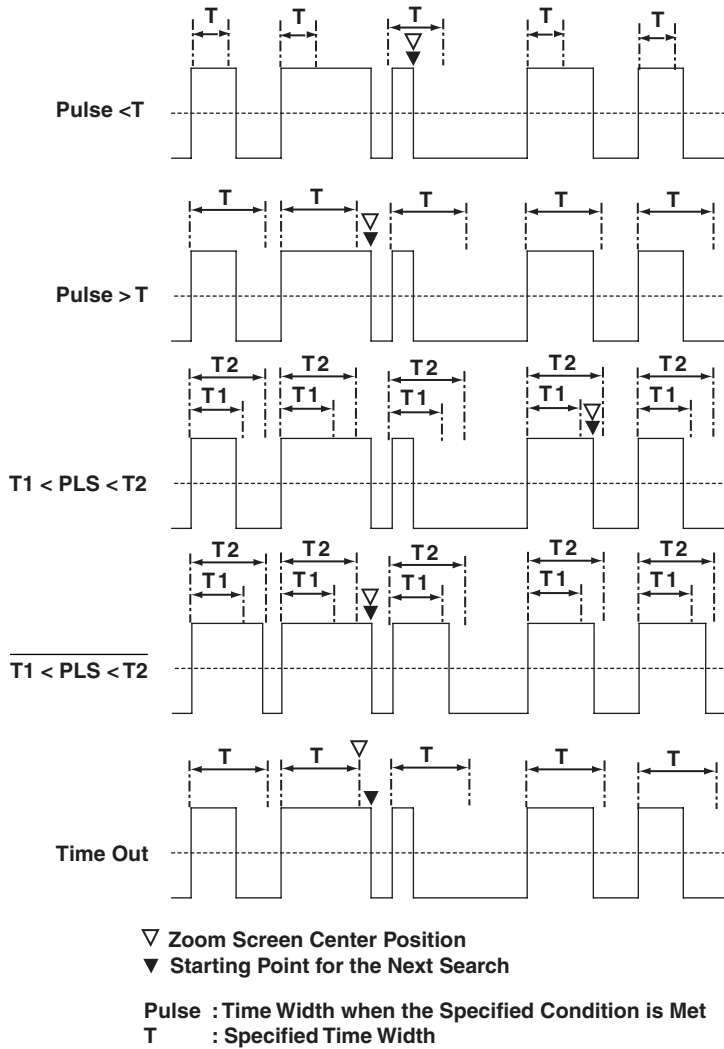

The center position of the waveform displayed in the zoom screen differs between Pulse > T and Time Out.

Auto Scroll

Set the scroll speed choosing from one of 7 steps. The higher the number, the faster the scrolling. You cannot set any settings other than direction and speed while auto scrolling.

9.1 Measuring Waveforms Using Cursors

<For a description of this function, see page 1-21>

Relevant Keys

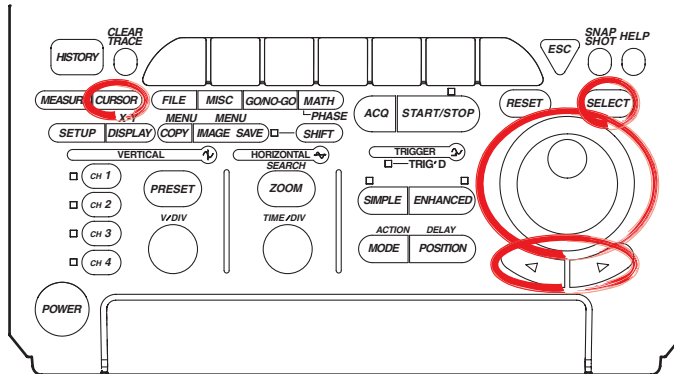

Operating Procedure

Selecting the Cursor Type

1. Press **CURSOR**.
2. Pressing the **Type** soft key displays the cursor type menu.

Type						CURSOR
OFF						

3. Press the soft key corresponding to the desired cursor type to select the cursor.

When not Displaying the X-Y Waveform

OFF	Horizontal	Vertical	Marker	Degree	H & U	Vertical History

When Displaying the X-Y Waveform

OFF	Horizontal	Vertical	H & U	Marker		CURSOR

For H (Horizontal) Cursors (When Not Displaying the X-Y Waveform)

Selecting the Waveform to be Measured

See steps 1-3 to set the **Type** to **Horizontal**.

OFF	Horizontal	Vertical	Marker	Degree	H & U	Vertical History

4. Pressing the **Trace** soft key displays the waveform menu.

Type	Trace	Cursor1					CURSOR
Horizontal	CH1	3.00d1v					
		Cursor2					
		-3.00d1v					

5. Press the soft key corresponding to the desired waveform. (CH3, CH4, and Math2 are not displayed on the DL1620.)

Type	CH1	CH2	CH3	CH4	Math1	Math2
Horizontal						
			-3.00d1v			

9.1 Measuring Waveforms Using Cursors

Moving the Cursor

- Press the **Cursor1/Cursor2** soft key to set the jog shuttle control to Cursor1.
- Turn the jog shuttle to move Cursor1.

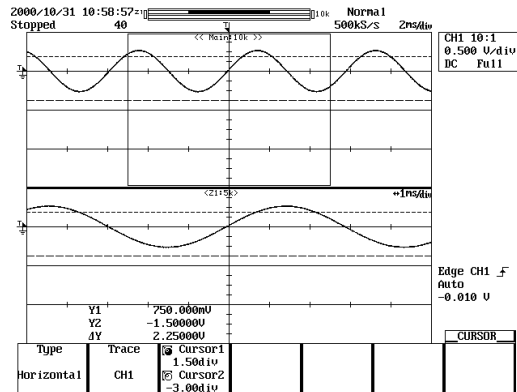

- Move Cursor2 in a similar fashion.
If the jog shuttle control is set to both Cursor1 and Cursor2, both cursors are moved.

For V (Vertical) Cursors (When Not Displaying the X-Y Waveform)

Selecting the Waveform to be Measured

See steps 1-3 to set the **Type** to **Vertical**.

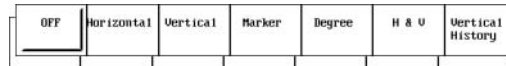

- Press the **Trace** soft key to display the waveform selection menu.

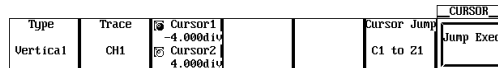

- Press the soft key corresponding to the desired waveform to select it. (CH3, CH4, and Math2 are not displayed on the DL1620.)

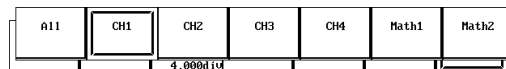

Moving the Cursor

- Press the **Cursor1/Cursor2** soft key to highlight the jog shuttle icon for Cursor1.
- Move Cursor1 using the jog shuttle.

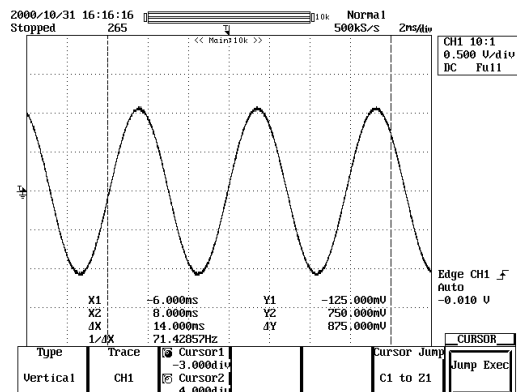

- In the same manner, move Cursor2. If you highlight the jog shuttle icon for Cursor1 and Cursor2, you can move them at the same time.

For Marker Cursors (When Not Displaying the X-Y Waveform)

Selecting the Marker

See steps 1-3 to set the **Type** to Marker.

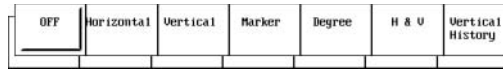

4. Press the **Select** soft key to select a marker from M1 to M4.

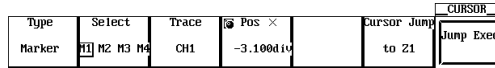

Selecting the Waveform to be Measured

5. Pressing the **Trace** soft key displays the waveform menu.
6. Press the soft key corresponding to the desired waveform. (CH3, CH4, and Math2 are not displayed on the DL1620.)

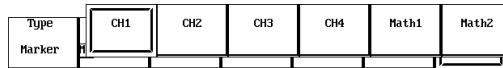

Moving the Cursor

7. Turn the jog shuttle to move the cursor. As the cursor is moved, the displayed value of Position changes.

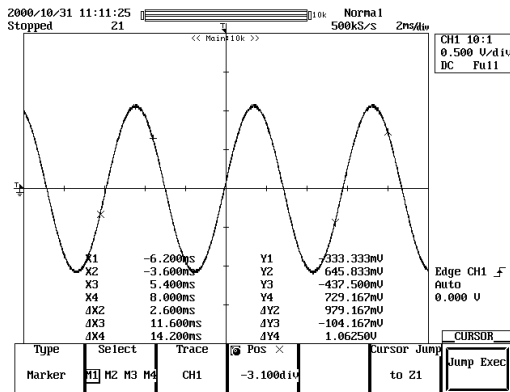

Note

When the T/div is not set to repetitive sampling mode and the averaging mode is not set to averaging mode, the sampled data may not appear on the V cursor on the interpolated display area (when less than 500 points of data exist within 10 divisions horizontally or when less than 250 points of data exist in the Z1Z2 display area for Main&Z1&Z2 waveform zoom). In this case, the V cursor value indicates the value of the nearest sampled data to the right of the cursor (for interpolated display, the sampled data is highlighted). However, the marker cursor is always displayed over the sampled data.

For Angle (Degree) Cursors (When Not Displaying the X-Y Waveform)

Selecting the Waveform to be Measured

See steps 1-3 to set the **Type** to **Degree**.

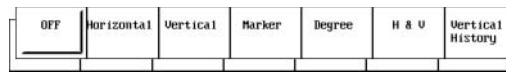

4. Pressing the **Trace** soft key displays the waveform menu.

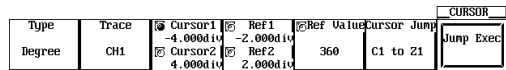

5. Press the soft key corresponding to the desired waveform. (CH3, CH4, and Math2 are not displayed on the DL1620.)

Moving the Cursor

6. Press the **Cursor1/Cursor2** soft key to set the jog shuttle control to Cursor1.

7. Turn the jog shuttle to move Cursor1.

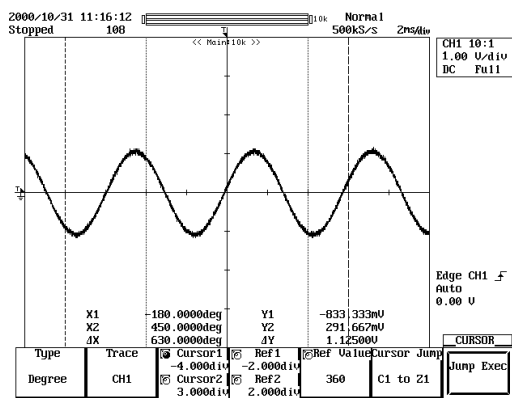

8. Move Cursor2 in a similar fashion.

If the jog shuttle control is set to both Cursor1 and Cursor2, both cursors are moved.

Moving the Reference Cursor

9. Press the **Ref1/Ref2** soft key to set the jog shuttle control to Ref1.

10. Turn the jog shuttle to move Ref1.

11. Move Ref2 in a similar fashion.

If the jog shuttle control is set to both Ref1 and Ref2, both cursors are moved.

Setting the Reference Angle

12. Press the **Ref Value** soft key.

13. Turn the jog shuttle to set the reference angle.

For H&V Cursors (When Not Displaying the X-Y Waveform)

Selecting the Waveform to be Measured

See steps 1-3 to set the **Type** to **H&V**.

OFF	Horizontal	Vertical	Marker	Degree	H & V	Vertical History
-----	------------	----------	--------	--------	-------	------------------

- Pressing the **Trace** soft key displays the waveform menu.

Type	Trace	Curs1	Curs2			CURSOR
H & V	CH1	-4.000div 4.000div	3.00div -3.00div			

- Press the soft key corresponding to the desired waveform. (CH3, CH4, and Math2 are not displayed on the DL1620.)

Type	CH1	CH2	CH3	CH4	Math1	Math2
H & V			4.000div -3.00div			

Moving the Cursor

- Press the **Curs1** / **Curs2** soft key to activate the jog shuttle on Curs1 (Cursor 1).
- Turn the jog shuttle to move Curs1 (Cursor 1).
- Move Curs2 (Cursor 2) in the same manner.
If you activate the jog shuttle on both Curs1 and Curs2, you can move both cursors at the same time.
- Move **Curs1** / **Curs2** in the same manner according to steps 6 through 8.

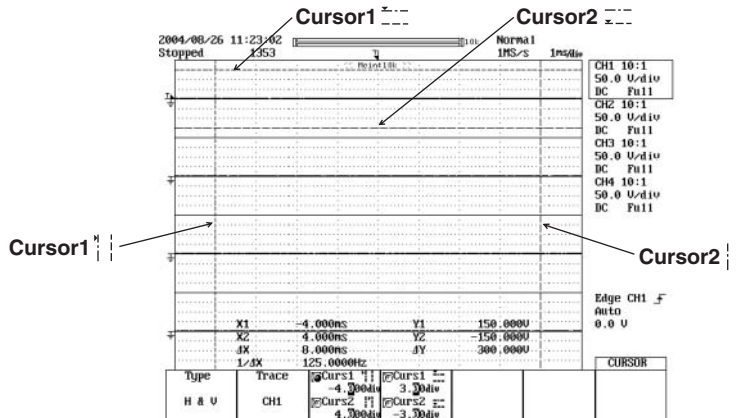

Measuring Historical Data with the V Cursors (Vertical History)

Selecting the Target Waveform

See steps 1-3 to set the **Type** to **Vertical History**.

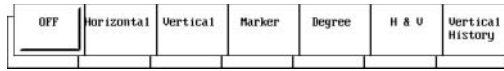

4. Pressing the **Trace** soft key displays the waveform menu.

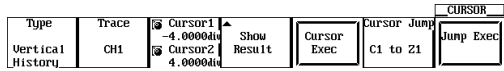

5. Press the soft key corresponding to the desired waveform. (CH3, CH4, and Math2 are not displayed on the DL1620.)

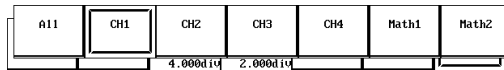

Moving the Cursor

6. Press the **Cursor1/Cursor2** soft key to set the jog shuttle control to Cursor1.

7. Turn the jog shuttle to move Cursor1.

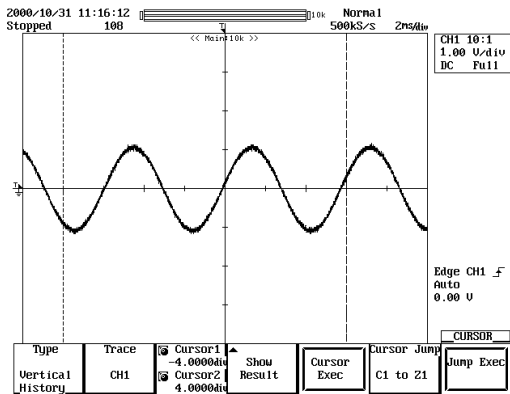

8. Move Cursor2 in a similar fashion.

If the jog shuttle control is set to both Cursor1 and Cursor2, both cursors are moved.

Performing Statistical Computations Between Cursors

9. Press the **Cursor Exec** soft key to perform statistical computations between cursors.

The results are displayed at the top of the screen.

Displaying the Cursor Position Measurement Values

10. Press the **Show Result** soft key to display the historical data for cursor position measurement values in a list.

Press the **Max/Min Item1** to **Min/Max Item4** soft keys to emphasize the maximum and minimum of each measurement value in the display. The displayed measurement values become Item1, Item2, Item3, and Item4, from the left.

Press the **Sort** soft key to sort the results ascending (FWD) or descending (REV).

Cursor Jump (for V-Cursor, Marker Cursor, Angle Cursor and Vertical History Cursor: Only when Not Displaying the X-Y Waveform)

See steps 1-3 to set the **Type** to **Vertical**, **Marker**, **Degree**, or **Vertical History**.

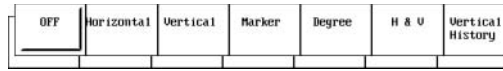

- Pressing the **Cursor Jump** soft key displays a menu used to select the cursor you wish to jump and the jump destination.

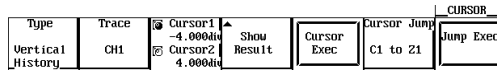
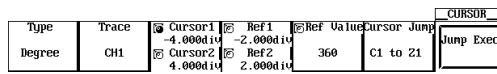
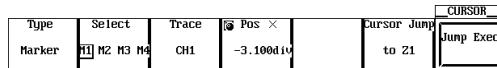
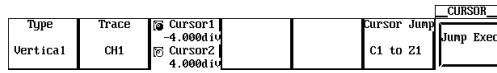

- Press the soft key corresponding to the desired jump type and select the cursor to jump and the jump destination.

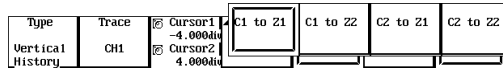
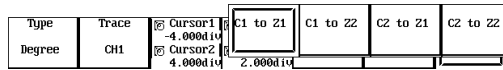
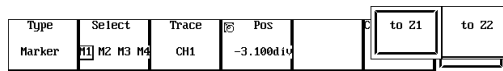
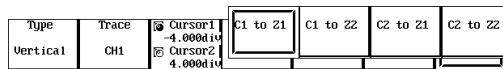

- Pressing the **Jump Exec** soft key moves the cursor to the jump destination.

For H (Horizontal) Cursors (When Displaying the X-Y Waveform)

Selecting the waveform to be measured

See steps 1-3 to set the **Type** to **Horizontal**.



4. Press the **Trace** soft key to select the desired waveform.

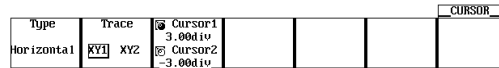

Moving the Cursor

5. Press the **Cursor1/Cursor2** soft key to set the jog shuttle control to Cursor1.
6. Turn the jog shuttle to move Cursor1.
7. Move Cursor2 in a similar fashion.

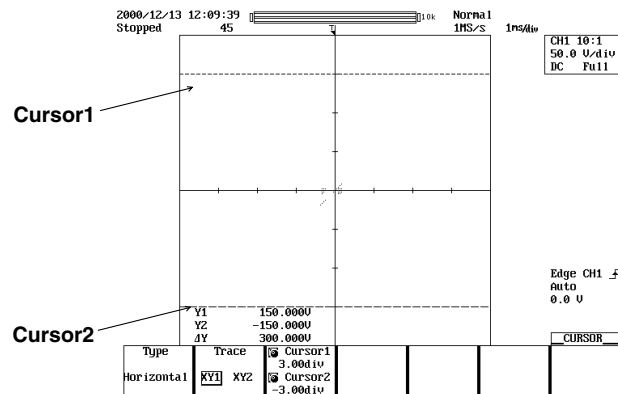

If the jog shuttle control is set to both Cursor1 and Cursor2, both cursors are moved.

For V (Vertical) Cursors (When Displaying the X-Y Waveform)

Selecting the Waveform to be Measured

See steps 1-3 to set the **Type** to **Vertical**.



4. Press the **Trace** soft key to select the desired waveform.

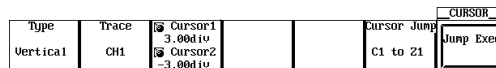

Moving the Cursor

5. Press the **Cursor1/Cursor2** soft key to set the jog shuttle control to Cursor1.
6. Turn the jog shuttle to move Cursor1.

7. Move Cursor2 in a similar fashion.

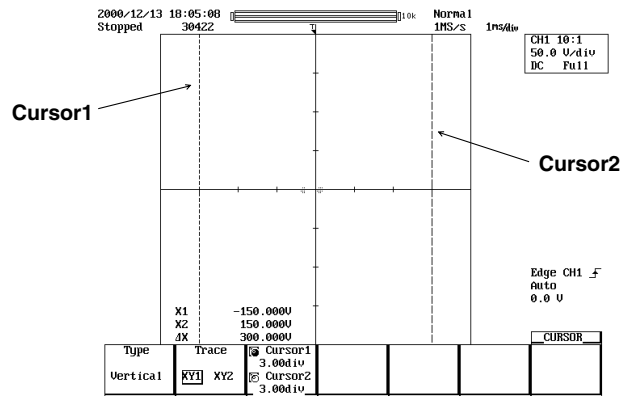

If the jog shuttle control is set to both Cursor1 and Cursor2, both cursors are moved.

For Marker Cursors (When Displaying the X-Y Waveform)

Selecting the Marker

See steps 1-3 to set the **Type** to **Marker**.



4. Press the **Trace** soft key to select the desired waveform.

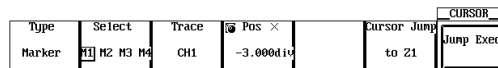

Moving the Cursor

5. Press the **Position** soft key to set the jog shuttle control to Position.
6. Turn the jog shuttle to move the cursor. As the cursor is moved, the displayed value of Position changes.

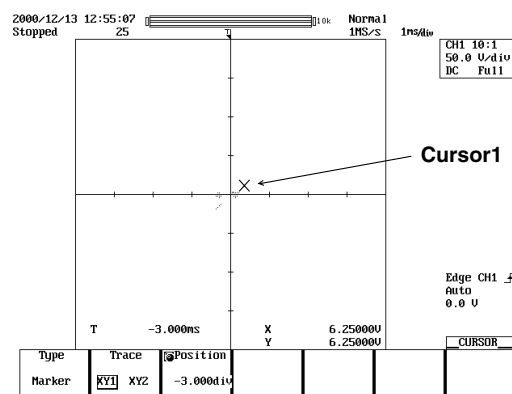

For H&V Cursors (When Displaying the X-Y Waveform)

Selecting the waveform to be measured

See steps 1-3 to set the **Type** to **H&V**.

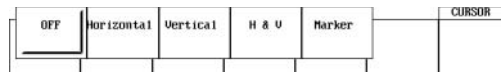

4. Press the **Trace** soft key and select the target waveform.

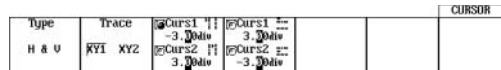

Moving the Cursor

5. Press the **Curs1** / **Curs2** soft key to activate the jog shuttle on Curs1 (Cursor 1).
6. Turn the jog shuttle to move Curs1 (Cursor 1).
7. Move Curs2 (Cursor 2) in the same manner. If you activate the jog shuttle on both Curs1 and Curs2, you can move both cursors at the same time.
8. Move **Curs1** / **Curs2** in the same manner according to steps 5 through 7.

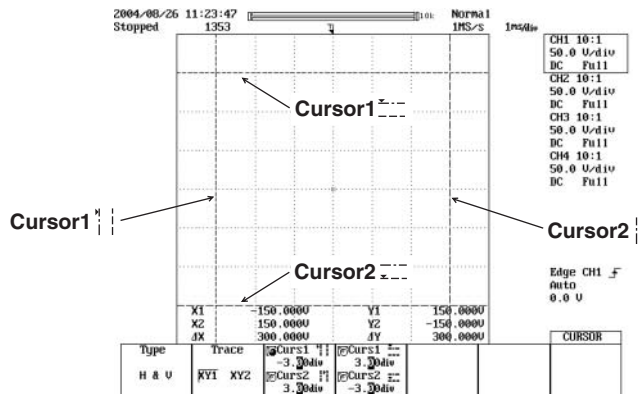

Explanation

Restrictions

Cursor measurements cannot be made on the following waveforms.

- Snapshot waveforms
- Accumulated waveforms other than the newest waveform

Cursor Types and Measurement Items: Type (When Not Displaying the X-Y Waveform)

- H (Horizontal) Cursor
Measures the Y-axis value at the cursor.
Y1: The Y-axis value at Cursor1
Y2: The Y-axis value at Cursor2
ΔY: The difference between the Y-axis values at Cursor1 and Cursor2
- V (Vertical) Cursor
Measures the X-axis value at the cursor. Also choose the order of the data.
X1: The X-axis value at Cursor1
X2: The X-axis value at Cursor2
ΔX: The difference between the X-axis values at Cursor1 and Cursor2
1/ΔX: The inverse of the difference between the X-axis values at Cursor1 and Cursor2
Y1: The Y-axis value at Cursor1
Y2: The Y-axis value at Cursor2
ΔY: The difference between the Y-axis values at Cursor1 and Cursor2

- Marker Cursors

Move the cursor on the waveform data and measure the waveform data values.
M1 (Marker 1) to M4 (Marker 4) can be set on different waveforms.

Y1 to Y4: The Y-axis values of M1 to M4

$\Delta Y2$: The difference between the Y-axis values of M1 and M2

$\Delta Y3$: The difference between the Y-axis values of M1 and M3

$\Delta Y4$: The difference between the Y-axis values of M1 and M4

X1 to X4: The X-axis values of M1 to M4

$\Delta X2$: The difference between the X-axis values of M1 to M2

$\Delta X3$: The difference between the X-axis values of M1 to M3

$\Delta X4$: The difference between the X-axis values of M1 to M4
- Angle Cursor (Degree)

Set the measurement zero point (position of reference cursor Ref1) and the end point (position of the reference cursor Ref2) on the X-axis within the screen and assign an angle corresponding to the width of Ref1 and Ref2. Using this angle as a reference, this function measures the angle of the two angle cursors (Cursor1 and Cursor2).

X1: The angle of Cursor1 from Ref1

X2: The angle of Cursor2 from Ref1

ΔX : The angle difference between Cursor1 and Cursor2

Y1: The Y-axis value of Cursor1

Y2: The Y-axis value of Cursor2

ΔY : The difference between the Y-axis values of Cursor1 and Cursor2

Range of reference width: 1 to 720°
- H&V Cursor

Measures the X and Y values at the cursor.

Y1: The Y axis value of horizontal Curs1 (Cursor1)

Y2: The Y axis value of horizontal Curs2 (Cursor2)

ΔY : The difference in Y axis values of horizontal Curs1 (Cursor1) and horizontal Curs2 (Cursor 2)

X1: The X axis value of vertical Curs1 (Cursor1)

X2: The X axis value of vertical Curs2 (Cursor2)

ΔX : The difference in X axis values of vertical Curs1 (Cursor1) and vertical Curs2 (Cursor 2)
- Vertical History Cursor (Vertical History)

Makes statistical computations of cursor position historical data.

X1: The X-axis value at Cursor1

X2: The X-axis value at Cursor2

ΔX : The difference between the X-axis values of Cursor1 and Cursor2

$1/\Delta X$: The inverse of the difference between the X-axis values of Cursor1 and Cursor2

Y1: The Y-axis value at Cursor1

Y2: The Y-axis value at Cursor2

ΔY : The difference between the Y-axis values of Cursor1 and Cursor2

Max: Maximum Y-axis value of Cursor1 or Cursor2

Min: Minimum Y-axis value of Cursor1 or Cursor2

Avg: Average Y-axis value of Cursor 1 or Cursor2

Sdv: Standard Y-axis deviation of Cursor1 or Cursor2

Cnt: Amount of data used in statistical computation for Cursor1 or Cursor2

The Y-axis values of Cursor1 and Cursor2 are displayed in a list. The maximum Y-axis value difference between Cursor1 and Cursor2 is indicated by an arrow pointing upward, and the minimum Y-axis value difference between Cursor1 and Cursor2 is indicated by an arrow pointing downward.

Cursor types and Measurement Items: Type (When Displaying the X-Y Waveform)

- H (Horizontal) Cursor
Measures the Y-axis value at the cursor.
Y1: The Y-axis value at Cursor1
Y2: The Y-axis value at Cursor2
 ΔY : The difference between the Y-axis values at Cursor1 and Cursor2
- V (Vertical) cursor
Measures the X-axis value at the cursor. When measuring the logic waveform with the V Cursor, select a binary or 16-base measurement value. Also choose the order of the data.
X1: The X-axis value at Cursor1
X2: The X-axis value at Cursor2
 ΔX : The difference between the Y-axis values at Cursor1 and Cursor2
- H&V Cursor
Measures the X and Y values at the cursor.
Y1: The Y axis value of horizontal Curs1 (Cursor1)
Y2: The Y axis value of horizontal Curs2 (Cursor2)
 ΔY : The difference in Y axis values of horizontal Curs1 (Cursor1) and horizontal Curs2 (Cursor 2)
X1: The X axis value of vertical Curs1 (Cursor1)
X2: The X axis value of vertical Curs2 (Cursor2)
 ΔX : The difference in X axis values of vertical Curs1 (Cursor1) and vertical Curs2 (Cursor 2)
- Marker Cursors
Move the cursor on the waveform data and measure the waveform data values.
T: The time difference from the trigger point at the cursor
X: The X-axis value at Cursor
Y: The Y-axis value at Cursor

Movement Range of the Cursors (When Not Displaying the X-Y Waveform)

H Cursors and H Cursors of H&V Cursors can be moved in the range from -4 to $+4$ div from the center of the screen. The resolution is 0.01 div.

V Cursors, marker cursors, angle cursors, V Cursors of H&V Cursors, and vertical history cursors can be moved in the range from -5 to $+5$ div from the center of the screen. The resolution is as follows:

Resolution: $T/\text{div} \times 10/\text{displayed record length}$

Movement Range of the Cursors (When Displaying the X-Y Waveform)

H Cursors, V Cursors, and H&V Cursors can be moved in the range from -4 to $+4$ div from the center of the screen. The resolution is 0.01 div.

Marker cursors can be moved in the range from -5 to $+5$ div from the center of the screen. The resolution is as follows:

Resolution: $T/\text{div} \times 10/\text{displayed record length}$

Cursor Jump (When Not Displaying the X-Y Waveform)

You can make Marker cursors, V cursors, angle cursors, and vertical history cursors jump to the center of the zoom window. The cursors can be jumped in the following manner.

For marker cursors

to Z1: Make the selected marker jump to the Z1 window.

to Z2: Make the selected marker jump to the Z2 window.

V cursor, angle cursor, and vertical history cursors

C1 to Z1: Make Cursor1 jump to the Z1 window

C1 to Z2: Make Cursor1 jump to the Z2 window

C2 to Z1: Make Cursor2 jump to the Z1 window

C2 to Z2: Make Cursor2 jump to the Z2 window

Notes when Making Cursor Measurements

- The time axis values are measured from the trigger position.
- The measured value will display "*****," if the measurement is not possible.

9.2 Automated Measurement of Waveform Parameters

<For a description of this function, see page 1-22>

Relevant Keys

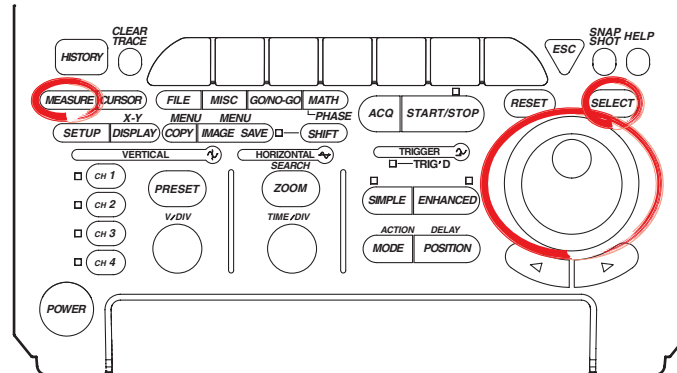

Operating Procedure

1. Press **MEASURE**.
2. Pressing the **Mode** soft key displays the automated measurement mode menu.

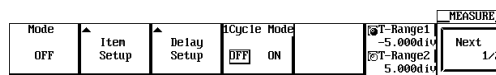

3. Press the **ON** soft key to set the automated measurement mode.

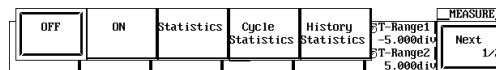

Selecting the Measurement Parameter

4. Pressing the **Item Setup** soft key displays the measurement parameter dialog box and the measurement channel dialog box.

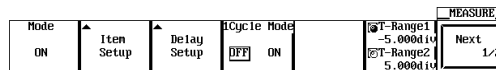

5. Press the soft key corresponding to the desired measurement channel. (CH3, CH4, and Math2 are not displayed on the DL1620.)

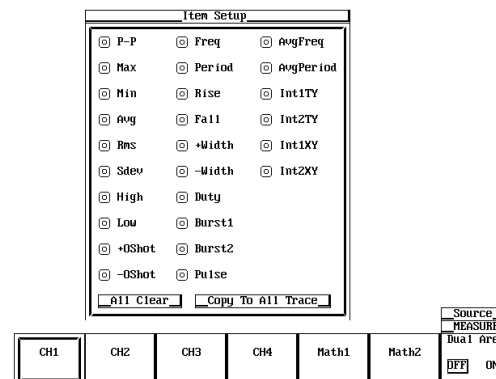

6. Turn the jog shuttle to move the cursor to the parameter you wish to turn ON. You can turn OFF all parameters at once by selecting All Clear. You can copy the current parameter settings to all traces by selecting Copy to All Trace. When the target channel is Math1 or Math2, Int1XY and Int2XY are not displayed.
7. Press **SELECT** to turn ON the parameter
8. Repeat steps 5 to 7 as necessary.

Setting the Delay (Delay Setup)

9. Pressing the **Delay Setup** soft key displays the delay setting menu and the measurement channel dialog box.
10. Press the soft key corresponding to the desired measurement channel. (CH3, CH4, and Math2 are not displayed on the DL1620.)

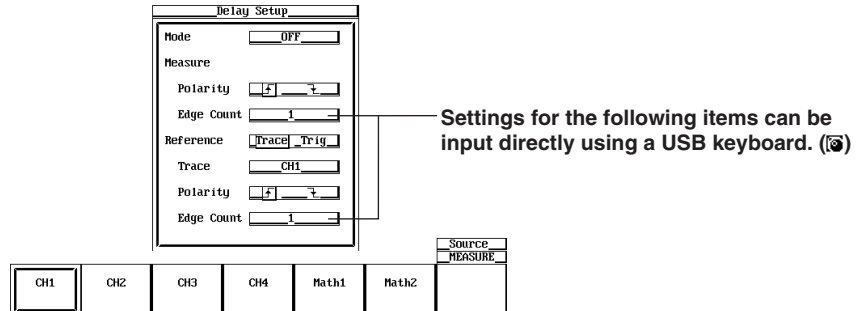

11. Turn the jog shuttle to move the cursor to Mode.
12. Press **SELECT** to select Time, Degree or OFF.

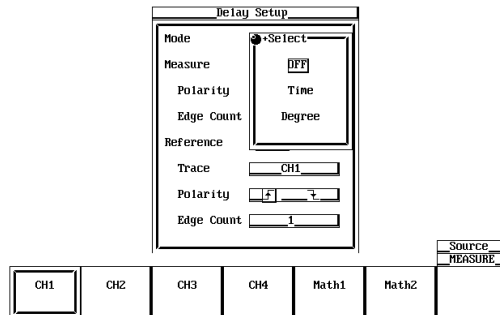

13. Turn the jog shuttle to move the cursor to Polarity under Measure.
14. Press **SELECT** to select whether to measure the rising edge (↑) or the falling edge (↓).
15. Turn the jog shuttle to move the cursor to Edge Count under Measure.
16. Press **SELECT**, and turn the jog shuttle to select on which rising or falling edge to make measurements.
17. Turn the jog shuttle to move the cursor to Reference.
18. Press **SELECT** to select whether the trace or the trigger is to be the reference.
19. Turn the jog shuttle to move the cursor to Trace.
20. Pressing **SELECT** displays the reference waveform menu.
21. Turn the jog shuttle to select the reference waveform, then press **SELECT**. (CH3, CH4, and Math2 are not displayed on the DL1620.)

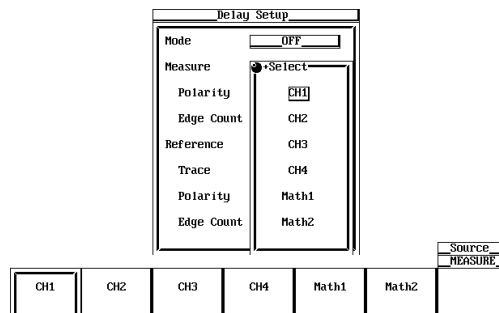

9.2 Automated Measurement of Waveform Parameters

22. Turn the jog shuttle to move the cursor to Polarity under Reference.
23. Press **SELECT** to select whether to make the rising (↗) or the falling (↘) edge the reference.
24. Turn the jog shuttle to move the cursor to Edge Count under Reference.
25. Press **SELECT** to select which rising or falling edge to make the reference.

Setting the 1 Cycle Mode

26. Press the **1 Cycle Mode** soft key to select ON or OFF.

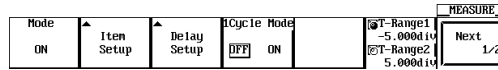

Setting the Measurement Range

27. Press the **T-Range1/T-Range2** soft key to set the jog shuttle control to T-Range1.
28. Turn the jog shuttle to set the start of the measurement range.
29. Press the **T-Range1/T-Range2** soft key to set the jog shuttle control to T-Range2.
30. Turn the jog shuttle to set the end of the measurement range.

Selecting the Target Waveform for Distal, Mesial, and Proximal Points

31. Press the **Next 1/2** soft key to display the Next 2/2 menu.

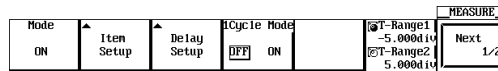

32. Pressing the **Trace** soft key displays the measured waveform menu.

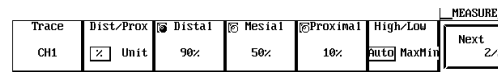

33. Press the soft key corresponding to the desired waveform. (CH3, CH4, and Math2 are not displayed on the DL1620.)

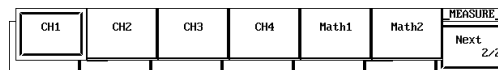

Setting the Distal, Mesial, and Proximal Unit (Dist/Prox)

34. Press the **Next 1/2** soft key to display the Next 2/2 menu.
35. Press the **Dist/Prox** soft key to select the distal, mesial, or proximal unit.

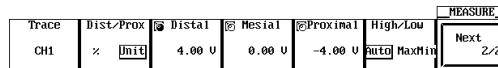
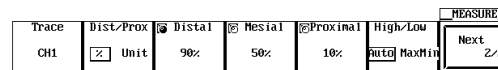

Setting the Distal, Mesial, and Proximal Points (Distal, Mesial, Proximal)

36. Press the **Next 1/2** soft key to display the Next 2/2 menu.
37. Press the **Distal**, **Mesial**, or **Proximal** soft key.
38. Turn the jog shuttle to set the distal, mesial, or proximal point.

Setting the High/Low Point

39. Press the **Next 1/2** soft key to display the Next 2/2 menu.
40. Press the **High/Low** soft key to select Auto or MaxMin.

Explanation

This function allows automated measurement of various parameters of the data stored in the acquisition memory. Up to 32000 data points of the result of the automated measurement can also be saved to a file. (See section 11.9, “Saving the Results of the Automated Measurement of Waveform Parameters.”)

Restrictions

Automated measurement of waveform parameters cannot be performed on the following waveforms.

- Snapshot waveforms
- Accumulated waveforms other than the newest waveform

Auto Measurement Mode

ON: Measures the specified item.

Statistic: Performs statistical computation on the measured result of the specified item. See section 9.3, “Statistical Processing.”

Selecting the High/Low Method: High-Low

High and *Low* correspond to the 100% level and the 0% level, respectively, that are used to measure rise and fall times and other parameters. Select one of the two methods used to set the High and Low levels.

- Auto
Based on the frequency of voltage levels of the waveform within the measurement range, the higher amplitude level is set to High and the lower amplitude level is set to Low taking into account the occurrences of ringing and spikes. This method is most suitable for measuring square waves and pulse waves.
- MaxMin
The maximum and minimum values within the measurement range are set to High and Low, respectively. This method is most suitable for measuring sine waves and saw waves. It is not suited to the measurement of waveforms that have ringing and spikes.

Setting the Distal, Proximal, and Mesial Values: Distal/Prox

Select the appropriate method to set the three levels that are to be used as reference for such measurements as rise and fall times.

- % (Percentage)
The distal, mesial, and proximal values are set in terms of percentages when High of any trace (CH1 to CH4, Math1, Math2 (or CH1, CH2, and Math1 for the DL1620)) and Low are taken to be 100% and 0%, respectively.
- Unit
Set the distal, mesial, and proximal values of any trace (CH1 to CH4, Math1, Math2 (or CH1, CH2, and Math1 for the DL1620)) to arbitrary voltage values.

Setting the Measurement Range: T-Range

With the default setting, the ± 5 div of the time axis display frame is the measurement range. However, this range can be shortened. The measurement range is set using two vertical cursors. The position of the fine dashed line is the measurement start point and the position of the coarse dashed line is the end point.

9.2 Automated Measurement of Waveform Parameters

Measurement Parameters: Items

You can select among the 26 types of measurement parameters shown below and delay between channels. Up to 32000 combinations of parameters of all traces (CH1 to CH4, Math1, Math2 (or CH1, CH2, and Math1 for the DL1620)) can be saved.

The parameters that can be displayed are as follows:

Auto Measurement Mode	Displayed Parameters
ON	Up to 12 parameters from all traces. The parameters of channels having smaller channel numbers have precedence. The parameters that appear higher in the parameter setting menu have precedence.
Statistics	Up to 2 parameters from all traces. Displays statistical data. Channels having smaller channel numbers have precedence.

• Voltage Axis Parameters

P-P : Peak to Peak Value (MAX - MIN) [V]	-Oshot : Undershoot Value (-Ovr)* (LOW - MIN)/(HIGH - LOW) x 100 [%]
Max : Maximum Voltage [V]	+Oshot : Overshoot Value (+Ovr)* (MAX - HIGH)/(HIGH - LOW) x 100 [%]
Min : Minimum Voltage [V]	High : High Level Voltage [V]
Rms : Root Mean Square Value $(1/\sqrt{n})(\sum xi)^2)^{1/2}$ [V]	Low : Low Level Voltage [V]
Avg : Average Voltage $(1/n)\sum xi$ [V]	
Sdev : Standard Deviation (SDV)* $(1/n(\sum xi^2 - (\sum xi)^2/n))^{1/2}$	

*() shows the corresponding name at the measurement item setting screen.

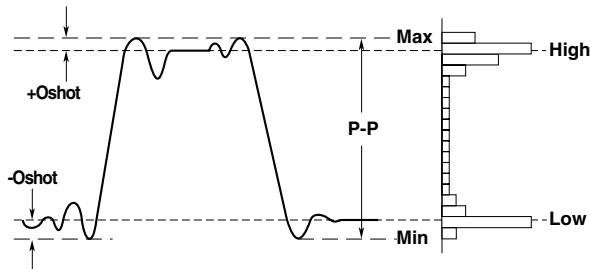

• Time Axis Parameters

Rise : Rise Time [s]	+Width : Width (s) Greater than the Mesial Value (+Wd)*
Fall : Fall Time [s]	-Width : Width (s) Smaller than the Mesial Value (-Wd)*
Freq : Frequency [Hz], 1/PERIOD	Duty : Duty Ratio + Width/Period x 100 [%]
Period : Period [s]	
(Prod)* Avg Freq : Mean Frequency in (FR-A)* Measuring Range [Hz]	
(PR-A)* Avg Period : Mean Period in (PR-A)* Measuring Range [s]	

*() shows the corresponding name at the measurement item setting screen.

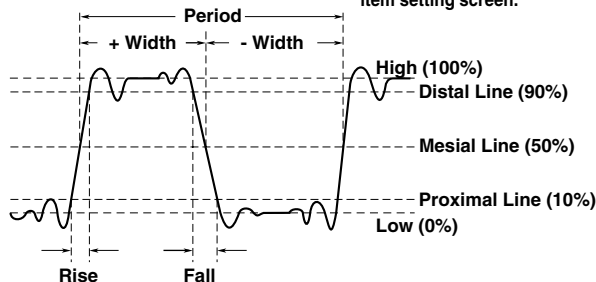

Pulse : Pulse Count
(PlsN)
When Pulse=3
Set the measurement range
(T-Range) to match the pulse
width of the signal being measured.

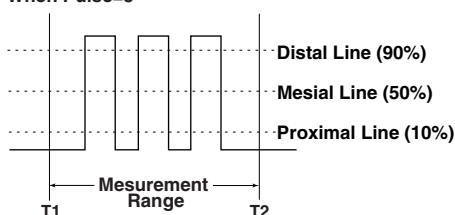

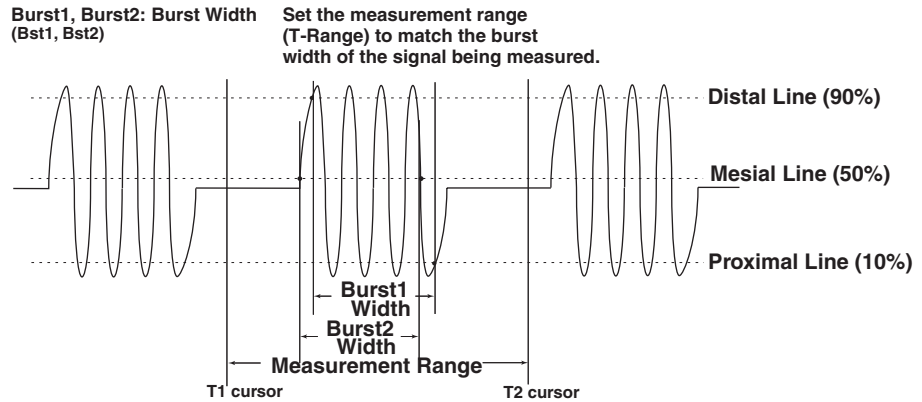

• Other Measurement Parameters

Int1TY: The area under the positive amplitude

Int2TY: (The area under the positive amplitude) - (the area under the negative amplitude)

Int1XY: The summation of the triangular area of the X-Y waveform

Int2XY: The summation of the trapezoidal area of the X-Y waveform

* For details regarding the area calculations, see Appendix 2, "How to Calculate the Area of a Waveform."

Delay between Channels:

The time difference between the rising or falling edges of trace waveforms or trigger points is called the *delay between channels*.

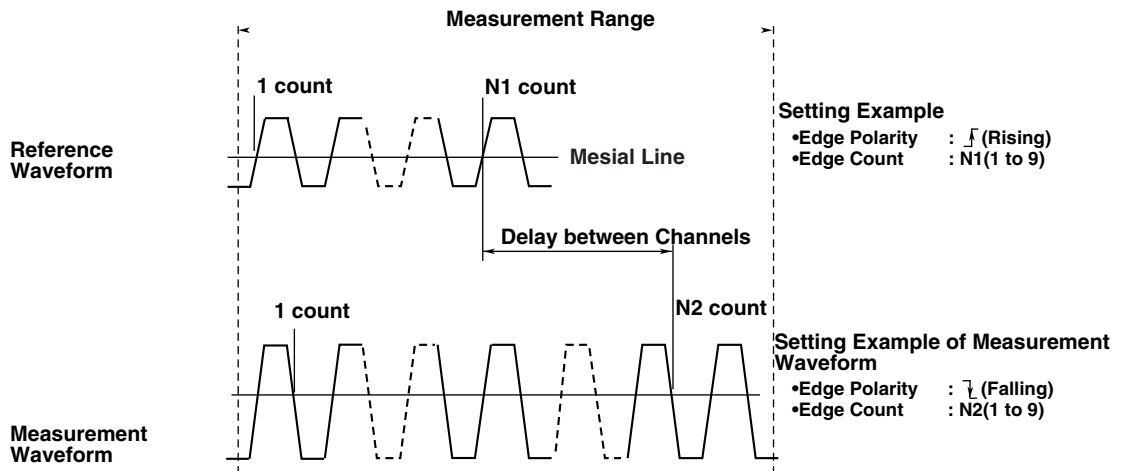

• If Mode is set to Time or Degree, measurements will be made. The default setting is OFF.

Time: Display the delay between channels as a time

Degree: Display the delay between channels as a degree

$$\text{Degree} = \text{Delay (s)} / \text{Period (s)} \times 360 \text{ (deg)}$$

The period is that of a standard waveform.

- Select rising \uparrow or falling \downarrow for the slope of the edge to be detected in Edge Polarity. The default setting is rising \uparrow .
- Set the number of edges to detect before actually considering it a detection point in Edge Count. The range is an integer from 1 to 9. The default setting is 1.
- The voltage level at the detection point is the mesial point.

9.2 Automated Measurement of Waveform Parameters

- The parameter name when the measured value is displayed is (Dly).

Note

If the Mode is set to Degree and the reference waveform is Trig, the measured value shows "*****."

Setting Proximal, Mesial, and Distal: Dist/Prox

Unit: According to Dist/Prox setting.

Proximal Range: 0 to 100 (resolution: 1%) or voltage corresponding to ± 8 div (resolution: $V/\text{div} \times 1/100$)

Mesial Range: 0 to 100 (resolution: 1%) or voltage corresponding to ± 8 div (resolution: $V/\text{div} \times 1/100$)

Distal Range: 0 to 100 (resolution: 1%) or voltage corresponding to ± 8 div (resolution: $V/\text{div} \times 1/100$)

Notes when Making Automated Measurement of Waveform Parameters

- The measured value will display "*****," if the measurement is not possible.
- If the waveform is of small amplitude, measurements may not produce correct results.
- When there are two or more cycles of a waveform in the measurement range, the time axis parameter measurement is made on the first cycle.
- When loading waveform data of the maximum record length, automatic measurement of waveform parameters cannot be performed on calculated waveforms. ***** is displayed for the measured results.

1 Cycle Mode

This mode is used to compute items related to the voltage axis or the area over one cycle after determining the cycle. This is suited to items such as Rms and Avg that produce errors depending on the measurement range.

This does not affect the items related to the time axis or the area of the X-Y waveforms. Every time the waveform is updated, the waveform parameters are measured automatically.

Note

When items Integ1TY, Integ1XY, Integ2TY, and Integ2XY are measured automatically, the completed percentage is displayed.

9.3 Statistical Processing

<For a description of this function, see page 1-22>

Relevant Keys

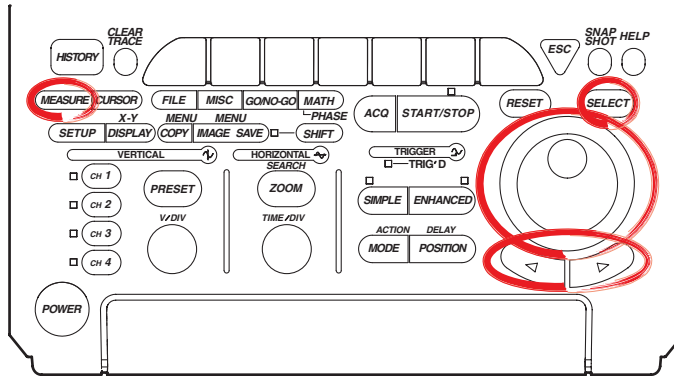

Operating Procedure

Statistical Processing

1. Press **MEASURE**.
2. Pressing the **Mode** soft key displays the automated measurement mode menu.

Mode	Item Setup	Delay Setup	Cycle Mode	T-Range1	MEASURE
OFF			OFF ON	-5.000d14	Next 1/2
				5.000d14	

3. Press the **Statistics** soft key to select the statistical processing.

OFF	ON	Statistics	Cycle Statistics	History Statistics	T-Range1	MEASURE
					-5.000d14	Next 1/2
					5.000d14	

4. Pressing the **Item Setup** soft key displays the measurement parameter menu and the measurement channel menu.

Mode	Item Setup	Delay Setup	Cycle Mode	T-Range1	MEASURE
Statistics			OFF ON	-5.000d14	Next 1/2
				5.000d14	

5. Press the soft key corresponding to the desired measurement channel. (CH3, CH4, and Math2 are not displayed on the DL1620.)

Item Setup						Source
<input type="checkbox"/> P-P	<input type="checkbox"/> Freq	<input type="checkbox"/> AvgFreq				MEASURE
<input type="checkbox"/> Max	<input type="checkbox"/> Period	<input type="checkbox"/> AvgPeriod				Dual Area
<input type="checkbox"/> Min	<input type="checkbox"/> Rise	<input type="checkbox"/> Int1TY				OFF ON
<input type="checkbox"/> Avg	<input type="checkbox"/> Fall	<input type="checkbox"/> Int2TY				
<input type="checkbox"/> Rms	<input type="checkbox"/> +Width	<input type="checkbox"/> Int1XY				
<input type="checkbox"/> Sdev	<input type="checkbox"/> -Width	<input type="checkbox"/> Int2XY				
<input type="checkbox"/> High	<input type="checkbox"/> Duty					
<input type="checkbox"/> Low	<input type="checkbox"/> Burst1					
<input type="checkbox"/> +Shot	<input type="checkbox"/> Burst2					
<input type="checkbox"/> -Shot	<input type="checkbox"/> Pulse					
<input type="checkbox"/> All Clear		<input type="checkbox"/> Copy To All Trace				
CH1	CH2	CH3	CH4	Math1	Math2	

6. Turn the jog shuttle to move the cursor to the parameter you wish to turn ON. You can turn OFF all parameters at once by selecting All Clear. You can copy the current parameter settings to all traces by selecting Copy to All Trace. When the target channel is Math1 or Math2, Int1XY and Int2XY are not displayed.
7. Press **SELECT** to select ON.

9.3 Statistical Processing

- Repeat steps 5 to 7 as necessary.

The setting of other parameters is the same as that of normal automated measurements (See section 9.2).

Statistical Processing by Period

- Press **MEASURE**.
- Press the **Mode** soft key to display the automatic measurement mode selection menu.

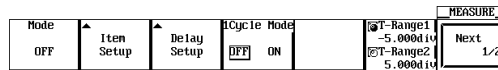

- Press the **Cycle Statistics** soft key to select the statistical processing by period.

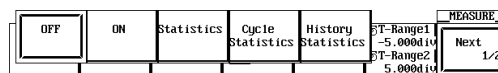

- Press the **Item Setup** soft key to display the measuring item dialog box and the measurement source channel selection menu.

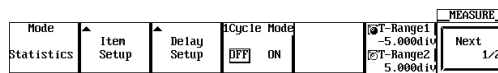

- Press the soft key corresponding to the desired measurement source channel to select it. (CH3, CH4, and Math2 are not displayed on the DL1620.)

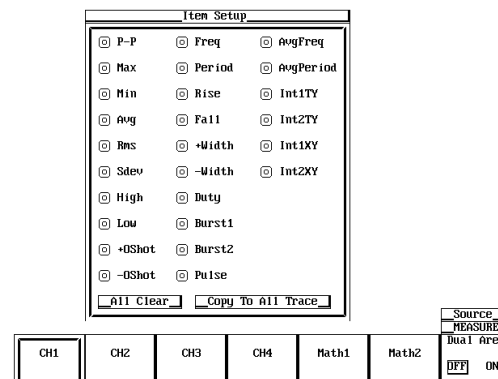

- Using the jog shuttle, move the cursor to the item that you wish to set to ON. If you select All Clear, all items are turned OFF. If you select Copy to All Trace, you can copy the current settings to all the traces. When the target channel is Math1 or Math2, Int1XY and Int2XY are not displayed.
- Press **SELECT** to turn ON an item.
- Repeat steps 5-7 as many times as necessary. Press **ESC** to return to the automatic measurement mode selection menu.
- Press the **Cycle Trace** soft key to display the period waveform selection menu.

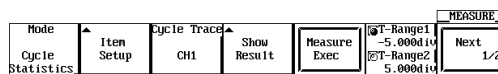

- Press the soft key corresponding to the source channel for the period. (CH3, CH4, and Math2 are not displayed on the DL1620.) If Own is selected, each waveform's own period is used for its statistical processing.

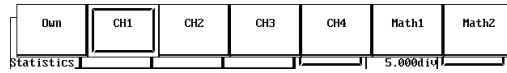

The other settings are the same as for normal automatic measurement (please see section 9.2).

- Press the **Measure Exec** soft key to perform the statistical processing. Press the key again to stop statistical processing.

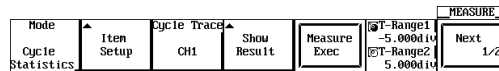

- Press the **Show Results** soft key to display a list of the automatic measurement results. Use the arrow keys to scroll the list horizontally, and the jog shuttle to scroll vertically.

Press the **Max/Min Item1 - Max/Min Item4** soft keys to move the cursor to the maximum and minimum values. From the left of the displayed parameters are Item1, Item2, Item3, and Item4. Press **SELECT** to zoom the first cycle of the cursor. You can change the order to ascending (FWD) or descending (REV) with the **Sort** soft key.

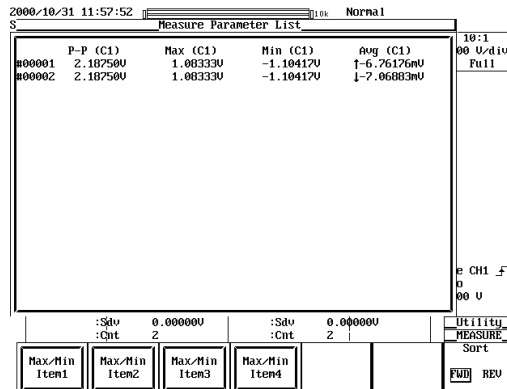

Statistical Processing with History Data

1. Press **MEASURE**.
2. Press the **Mode** soft key to display the automatic measurement mode selection menu.

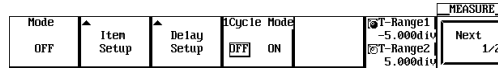

3. Press the **History Statistics** soft key to select the statistical processing with history data.

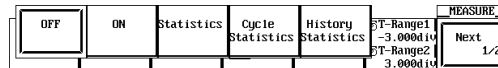

4. Press the **Item Setup** soft key to display the measurement item dialog box and the measuring source channel selection menu.

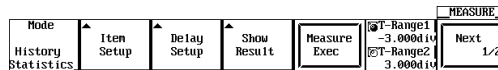

5. Press the soft key corresponding to the measuring source channel to select it. (CH3, CH4, and Math2 are not displayed on the DL1620.)

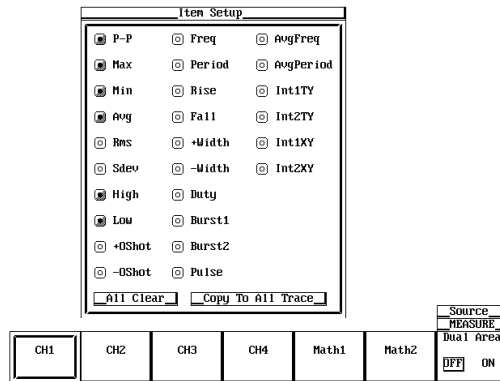

6. Using the jog shuttle, move the cursor to the item you wish to turn ON. If you select All Clear, you can turn OFF all the items at once. If you select Copy to All Trace, you can copy the current settings to all of the traces. When the target channel is Math1 or Math2, Int1XY and Int2XY are not displayed.
7. Press **SELECT** to turn ON the item.
8. Repeat steps 5-7 as many times as necessary. Press **ESC** to return to the automatic measurement mode selection menu.

The other settings are the same as for normal automatic measurement.

- Press the **Measure Exec** soft key to execute the statistical processing. Press the key again to stop the statistical processing.

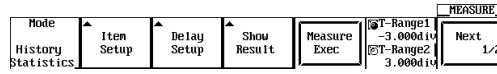

- Press the **Show Result** soft key to list the automatic measurement results. Use the arrow keys to scroll the list horizontally, and the jog shuttle to scroll it vertically. Press the **Max/Min Item1 - Max/Min Item4** soft keys to move the cursor to the maximum and minimum values of each parameter. From the left side of the displayed parameter is Item1, Item2, Item3, and Item4. Press **SELECT** to list the history waveform indicated by the cursor. You can change the order to ascending (FWD) or descending (REV) with the **Sort** soft key.

P-P (C1)	Max (C1)	Min (C1)	Avg (C1)	Sdv	Cnt
#00001 2.187500	1.083330	-1.104170	-4.419400		
#00002 2.187500	1.083330	-1.104170	-4.398570		
#00003 2.187500	1.083330	-1.104170	-4.412460		
#00004 2.187500	1.083330	-1.104170	-4.546910		
#00005 2.187500	1.083330	-1.104170	-4.367330		
#00006 2.187500	1.083330	-1.104170	-4.551320		
#00007 2.187500	1.083330	-1.104170	-4.458650		
#00008 2.187500	1.083330	-1.104170	-4.652000		
#00009 2.187500	1.083330	-1.104170	-4.289010		
#00010 2.187500	1.083330	-1.104170	-4.655470		
#00011 2.187500	1.083330	-1.104170	-4.346500		
#00012 2.187500	1.083330	-1.104170	-4.704080		
#00013 2.187500	1.083330	-1.104170	-4.263180		
#00014 2.166670	1.083330	-1.083330	-4.582570		
#00015 2.187500	1.083330	-1.104170	-4.311760		
#00016 2.187500	1.083330	-1.104170	-4.415730		
#00017 2.187500	1.083330	-1.104170	-4.492310		
#00018 2.187500	1.083330	-1.104170	-4.398570		
#00019 2.286530	1.104170	-1.104170	-4.655470		

Annotations:
 - Minimum Value of P-P(CH1) points to the first row.
 - Maximum Value of P-P(CH1) points to the last row.

Bottom soft keys:
 - Max/Min Item1, Max/Min Item2, Max/Min Item3, Max/Min Item4
 - Sort (FWD, REV)

Explanation

Performs statistical processing on the same measurement parameters as those of the automated measurement of waveform parameters. The following five statistics are determined on the two measured values of automated measurement parameters.

- Max: Maximum value
- Min: Minimum value
- Avg: Average value
- Sdv: Standard deviation
- Cnt: Number of measured values used in the statistical processing

For example, if you selected P-P of CH1 as an automated measurement parameter, the maximum, minimum, average, standard deviation, and the number of measured values used in the statistical processing of the P-P of CH1 are displayed.

The result of statistical processing that can be displayed is two parameters of automated measurement. If you selected three or more parameters for automated measurement, the first two parameters in the automated measurement parameter selection menu under Item Setup (P-P, Max, Min, ..., Init1XY, and Init2XY) are displayed starting from the smallest-numbered channel.

For example, if you selected P-P of CH1, Min of CH2, and Max of CH3, P-P of CH1 and Min of CH2 are displayed. The results of statistical processing that are not displayed can be loaded into a PC using the communication function. For details, see the communications interface user's manual.

The following three methods of statistical processing are available:

- **Normal Statistical Processing (Statistics)**

Statistical processing is performed on all acquired waveforms while acquiring waveforms. If you stop waveform acquisition and start it again, statistical processing continues from where it left off.

Statistical processing is performed on the selected parameters for automated measurement that are not displayed. Therefore, if you exclude statistical processing on the automated measurement parameter that is being displayed while waveform acquisition is in progress, the result of the statistical processing of the next selected parameter for automated measurement is displayed. The number of measured values used in the statistical processing (Cnt) is the number of waveforms that have been acquired up to that point.

If you add statistical processing on a new automated measurement parameter while waveform acquisition is in progress or when it is stopped, the number of measured values used in the statistical processing (Cnt) is the number of waveforms that have been acquired since the parameter was added.

- **Statistical Processing for Each Period**

Determines the period of the displayed waveform from the oldest data, measures the selected parameters for automated measurement on the data within the period, and performs statistical processing. The period is determined in the same fashion as the period for the waveform parameter. You can select whether to apply the period of the specified waveform to all waveforms or determine the period for each waveform.

CH1 to CH4, Math1, Math2: Apply the period of the specified waveform to all relevant (CH1, CH2, and Math1 waveforms and perform statistical processing for the DL1620)

Own: Determine the period for each relevant waveform and perform statistical processing.

Statistical processing is performed from the oldest data of the displayed waveform in blocks of periods.

It can not be used with the 1 cycle mode at the same time.

In addition, the following waveform parameters are not measured:

For waveforms whose period is measured:

Avg Freq (average frequency), Avg Period (average period), PlsN (pulse count), Int1XY (area), Int2XY (area), and Delay.

For other waveforms: Int1XY (area), Int2XY (area), and Delay.

Note

Statistical processing for each period is not possible on automated measurement of waveform parameters on dual areas described in section 9.4.

- **Statistical Processing of Historical Data**

Performs automated measurement of waveform parameters on waveforms that were acquired using the history memory function and performs statistical processing.

Statistical processing is performed from the oldest waveform. The range on which the statistics are measured is the waveform that is displayed on Show Map.

It can be used with Delay and 1 cycle mode.

Target Waveforms

CH1 to CH4, Math1, Math (CH1, CH2, and Math1 for the DL1620).

Automated Measurement Parameters for Statistical Processing

Items of statistical processing per period are given in section 9.2. Items of other statistical processing are indicated in section 9.2 and 9.4. The result of statistical processing that can be displayed is only two parameters of automated measurement.

Measurement Range during Statistical Processing

The measurement range is the same as that specified for normal automated measurement (see section 9.2 and 9.4).

Show Results

If you perform statistical processing for each period or statistical processing of historical data, a list of measured results can be displayed for the selected automated measurement parameters.

The waveforms are numbered from the oldest historical data, and the corresponding results of automated measurement are displayed.

The maximum and minimum values of each waveform parameter are displayed with the ↑ (maximum) and ↓ (minimum) symbols. If there are multiple points that are of the same value, the maximum and minimum values are marked on the oldest data.

The number of data points that can be listed is 32000. If this value is exceeded, the most recent 32000 points of automated measurement parameters of historical waveforms or data are displayed. In this case, the maximum and minimum values may exist outside the displayed list. In such cases, the maximum ↑ and minimum ↓ values outside the range are not displayed.

In the list of statistical processing of historical data, you can select a waveform using the jog shuttle and press **SELECT** to display the selected historical waveform.

For the statistical processing per period, statistical processing is performed only on the data that can be listed.

In the list displaying the first-cycle statistical processing results, use the jog shuttle to select a cycle number and press **SELECT** to zoom the waveform of the selected cycle.

Notes when Performing Statistical Processing

All soft keys except the **Measure Abort** soft key are disabled while the statistical processing is in progress.

When loading waveform data of the maximum record length, statistical processing cannot be performed on calculated waveforms. ***** is displayed for the measured results.

Note

When performing statistical processing for each cycle, the completed percentage is displayed.

9.4 Performing Automated Measurements of Waveform Parameters on Dual Areas

<For a description of this function, see page 1-23>

Relevant Keys

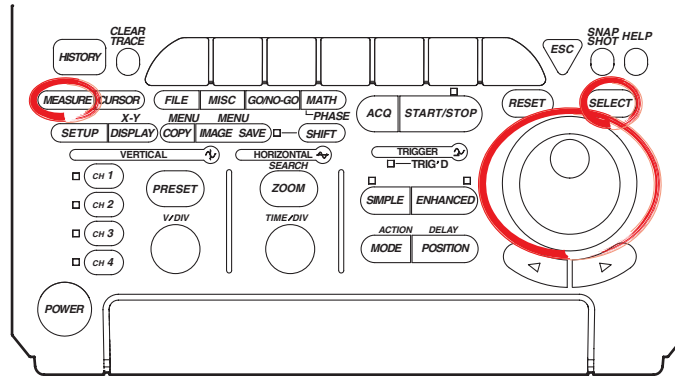

Operating Procedure

1. Press **MEASURE**.
2. Press the **Mode** soft key to display the automated measurement mode menu.

Mode	Item Setup	Delay Setup	Cycle Mode	OFF	ON	T-Range1 -5.000div	T-Range2 5.000div	MEASURE	Next	1/2
------	------------	-------------	------------	-----	----	-----------------------	----------------------	---------	------	-----

3. Press the **ON** soft key to set the automated measurement mode.

OFF	ON	Statistics	Cycle Statistics	History Statistics	T-Range1 -5.000div	T-Range2 5.000div	MEASURE	Next	1/2
-----	----	------------	------------------	--------------------	-----------------------	----------------------	---------	------	-----

Selecting the Measurement Parameter

4. Press the **Item Setup** soft key. **Dual Area** is displayed at the right end of the soft key menu.

Mode	Item Setup	Delay Setup	Cycle Mode	OFF	ON	T-Range1 -5.000div	T-Range2 5.000div	MEASURE	Next	1/2
------	------------	-------------	------------	-----	----	-----------------------	----------------------	---------	------	-----

5. Press the **Dual Area** soft key to turn it ON. (To return to the usual automated measurement screen, press the **Dual Area** soft key again to turn it OFF.) (CH3, CH4, and Math2 are not displayed on the DL1620.)

Item Setup										
<input type="checkbox"/> P-P	<input type="checkbox"/> Freq	<input type="checkbox"/> AvgFreq								
<input type="checkbox"/> Max	<input type="checkbox"/> Period	<input type="checkbox"/> AvgPeriod								
<input type="checkbox"/> Min	<input type="checkbox"/> Rise	<input type="checkbox"/> Int1TY								
<input type="checkbox"/> Avg	<input type="checkbox"/> Fall	<input type="checkbox"/> Int2TY								
<input type="checkbox"/> Rms	<input type="checkbox"/> +Width	<input type="checkbox"/> Int1XY								
<input type="checkbox"/> Sdev	<input type="checkbox"/> -Width	<input type="checkbox"/> Int2XY								
<input type="checkbox"/> High	<input type="checkbox"/> Duty									
<input type="checkbox"/> Low	<input type="checkbox"/> Burst1									
<input type="checkbox"/> +Shot	<input type="checkbox"/> Burst2									
<input type="checkbox"/> -Shot	<input type="checkbox"/> Pulse									
All Clear		Copy To All Trace								
CH1	CH2	CH3	CH4	Math1	Math2	Source	MEASURE	Dual Area	OFF	ON

9.4 Performing Automated Measurements of Waveform Parameters on Dual Areas

- Press the **Item Setup** soft key to display the waveform parameter dialog box.

Area1		Area2	
Mode	Trace	Item	Ope
User1	OFF ON	CH1	P-P
User2	OFF ON	CH3	Min
User3	OFF ON	Math1	Period
User4	OFF ON	None	Int1XY

Area2		Unit	
Trace	Item	Unit	
CH2	Max		
CH4	Rms		
Math2	AvgPeriod		
Const1	Int2XY		

Const1	1.0000E+00	Const2	1.0000E+00
Const3	1.0000E+00	Const4	1.0000E+00

Dual Area MEASURE	
Dual Area	MEASURE
Item Setup	OFF ON

- Turn the jog shuttle to move the cursor to Mode of User1 and press **SELECT** to turn it ON.
- Turn the jog shuttle to move the cursor to Trace of Area1 of User1 and press **SELECT** to select the trace from CH1 through CH4, Math1, Math2, None, and Const1 through Const4 (CH, CH2, Math1, None, and Const1 through Const4 for the DL1620). If you select None or Const1 through Const4, waveform parameters are not measured in Area1.

- Turn the jog shuttle to move the cursor to Item of Area1 of User1 and press **SELECT** to select the measurement parameter from P-P through Int2XY.

- Turn the jog shuttle to move the cursor to Ope of User1 and press **SELECT** to select the computation from +, -, *, and /.

- Set Trace, Item, and Unit for Area2 in a similar fashion.
- To set constants, turn the jog shuttle to move the cursor to Const1 through Const4.
- Press **SELECT**, and set the constant using the jog shuttle. You can set up to four constants.

9.4 Performing Automated Measurements of Waveform Parameters on Dual Areas

14. To set User2 through User4, repeat steps 7 through 13 as necessary.

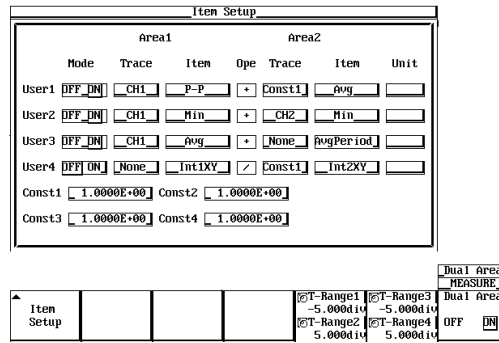

Setting the Measurement Range

15. Press **ESC**.
16. To set the measurement range of Area1, press the **T-Range1/T-Range2** soft key.

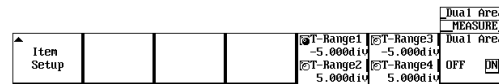

17. Set the measurement start point of Area1. If the jog shuttle action is not set to T-Range1, press the **T-Range1/T-Range2** soft key to set the action to T-Range1.
18. Turn the jog shuttle to set the start point of the measurement range.
19. Set the measurement end point of Area1. Press the **T-Range1/T-Range2** soft key to set the jog shuttle action to T-Range2.
20. Turn the jog shuttle to set the end point of the measurement range.
21. Set the measurement range of Area2 in a similar fashion by pressing the **T-Range3/T-Range4** soft key.

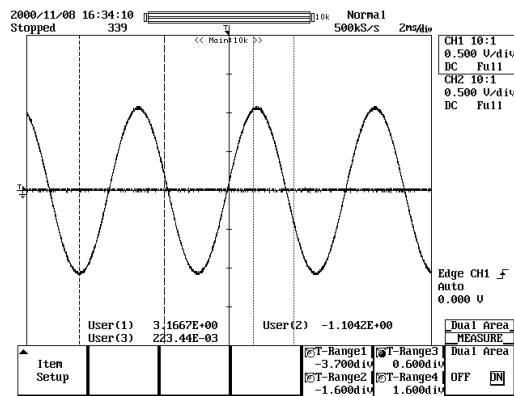

Selecting the Target Waveform of Distal, Mesial, and Proximal Points

- 22. Press **ESC**.
- 23. Press the **Next 1/2** soft key to display the Next 2/2 menu.

Mode	Item Setup	Delay Setup	Cycle Mode	T-Range1	MEASURE
ON			OFF ON	-3.780dV	Next 1/2
				-1.660dV	

- 24. Press the **Trace** soft key to display the target waveform selection menu.

Trace	Dist/Prox	Distal	Mesial	Proximal	High/Low	MEASURE
CH1	Unit	90%	50%	10%	AUTO MaxMin	Next 2/2

- 25. Press the soft key corresponding to the desired waveform to select the target waveform. (CH3, CH4, and Math2 are not displayed on the DL1620.)

CH1	CH2	CH3	CH4	Math1	Math2	MEASURE
						Next 2/2

Unit for Distal, Mesial, and Proximal Points (Dist/Prox)

- 26. Press the **Next 1/2** soft key to display the Next 2/2 menu.
- 27. Press the **Dist/Prox** soft key to select the unit for distal, mesial, and proximal points.

Trace	Dist/Prox	Distal	Mesial	Proximal	High/Low	MEASURE
CH1	Unit	90%	50%	10%	AUTO MaxMin	Next 2/2

Setting the Distal, Mesial, and Proximal Points (Distal, Mesial, and Proximal)

- 28. Press the **Next 1/2** soft key to display the Next 2/2 menu.
- 29. Press the **Distal, Mesial, or Proximal** soft key.

Trace	Dist/Prox	Distal	Mesial	Proximal	High/Low	MEASURE
CH1	Unit	4.00 U	0.00 U	-4.00 U	AUTO MaxMin	Next 2/2

- 30. Set the distal point, mesial point, and proximal point using the jog shuttle.

Setting the High and Low Points

- 31. Press the **Next 1/2** soft key to display the Next 2/2 menu.
- 32. Press the **High/Low** soft key to select Auto or MaxMin.

Trace	Dist/Prox	Distal	Mesial	Proximal	High/Low	MEASURE
CH1	Unit	4.00 U	0.00 U	-4.00 U	AUTO MaxMin	Next 2/2

Explanation

You can perform automated measurement of various measurement parameters (waveform parameters) on the data retrieved in the acquisition memory over two areas. You can also perform computation on the measurement parameter (waveform parameter) values that are determined in the two areas.

Waveforms Excluded from Measurements

The following waveform measurements are not possible in the automated measurement of waveform parameters.

- Snapshot waveforms
- Accumulated waveforms other than the newest waveform.

Automated Measurement Mode

ON: Performs computation between arbitrary items in Area1 and Area2.

Statistics: Performs statistical processing on the computed results between arbitrary items in Area1 and Area2. See section 9.3, "Statistical Processing."

Note

Statistical processing for each period (Cycle Statistics) is not possible.

Selecting the High/Low Assignment Method: High-Low

High indicates the 100% level in measurements such as the rise or fall time. And, Low indicates the 0% level. Select the assignment method of High and Low from the following two methods.

- Auto
Sets the higher amplitude level to High and lower level to Low within the measurement range based on the voltage level frequency of the waveform by taking the effects of ringing, spikes, etc. into consideration. This method is best-suited when measuring rectangular waveforms and pulse waveforms.
- MaxMin
Sets the maximum value to High and lowest value to Low in the measurement range. This method is best-suited when measuring sine waveforms, ramp waveforms, etc. It is not suited for measurement of waveforms with ringing and spikes.

Setting the Distal, Proximal, and Mesial Values: Distal/Prox

Select the method of assigning the three levels that are used as references in measurements such as the rise and fall times.

- % (Percentage)
Set the distal value, mesial value, and proximal value using a percentage with respect to an arbitrary trace (CH1 through CH4, Math1, and Math2 (or CH1, CH2, and Math1 for the DL1620)) with High set to 100% and Low set to 0%.
- Unit
Set the distal value, mesial value, and proximal value of an arbitrary trace (CH1 through CH4, Math1, and Math2 (or CH1, CH2, and Math1 for the DL1620)) to an arbitrary voltage.

Setting the Measurement Range: T-Range

Set the measurement range of Area1 using T-Range1 and T-Range2. Set the measurement range of Area2 using T-Range3 and T-Range4. In the initial setting, the measurement range is ± 5 divisions of the display frame on the time axis. You can limit this range. The measurement range is specified using two vertical cursors for each area. In Area1, the measurement start point is the position where the fine dotted line is located, and the measurement end point is the position where the coarse dotted line is located. In Area2, both the measurement start point and measurement end point are where the fine dotted line is located. The measurement ranges of Area1 and Area2 can be specified redundantly.

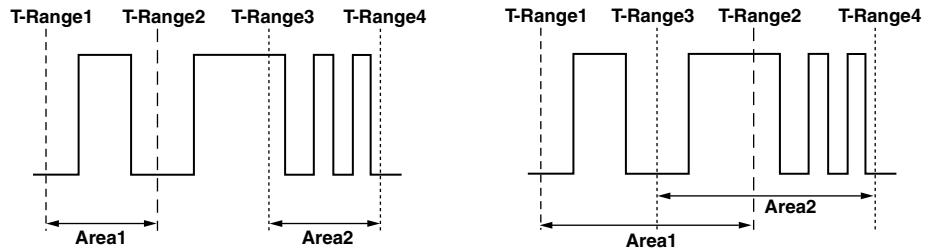

Dual Area Measurement Mode: Mode

If you set the mode in the Item Setup menu to ON, the measurement result is displayed in the two areas. You can select User1 through User4.

Measurement Trace: Trace

You can select the trace from 11 types (or from 8 types on the DL1620: CH1, CH2, Math1, None, and Const1 through Const4.): CH1 through 4, Math1, Math2, None, and Const1 through Const4. Const1 through Const4 are constants that can be specified arbitrarily.

Measurement Parameters: Items

Select from 27 types of measurement parameters (P-P, Max, Min, Rms, Avg, Sdev, High, Low, +OShot, -OShot, Freq, Period, Rise, Fall, +Width, -Width, Duty, Burst1, Burst2, Pulse, Delay, AvgFreq, AvgPeriod, Int1TY, Int2TY, Int1XY, and Int2XY). When the measurement trace is Math1 or Math2 (or Math1 for the DL1620), it is not possible to select Int1XY or Int2XY. For details on each item, see the “Measurement Parameters: Items” and “Delay between channels: Delay Setup” sections in section 9.2. If you set the measurement trace to None or Const1 through Const4, you cannot select the measurement parameter.

Computation: Ope

Select the computation to be performed between items of Area1 and Area2. You can select +, -, *, or /. If you set the measurement trace to None, the computation is not performed. In this case, the value of the measurement parameter in the other area is displayed.

Setting Proximal, Mesial, and Distal: Dist/Prox

- Unit: Dist/Prox
- Selectable Range of Proximal: 0 to 100 (1% steps) or voltage corresponding to ± 8 divisions (1/100 of V/div steps)
- Selectable Range of Mesial: 0 to 100 (1% steps) or voltage corresponding to ± 8 divisions (1/100 of V/div steps)
- Selectable Range of Distal: 0 to 100 (1% steps) or voltage corresponding to ± 8 divisions (1/100 of V/div steps)

9.4 Performing Automated Measurements of Waveform Parameters on Dual Areas

Precautions to be Taken when Performing Automated Measurement of Waveform Parameters

- The measurement value displays "*****" if the measurement is not possible.
- For waveforms of small amplitude, correct measurements may not be possible.
- When there are two or more periods of waveform in the measurement range, the time axis parameter measurement is performed on the first cycle.
- Every time the waveform is updated, the waveform parameters are measured automatically.
- When loading waveform data of the maximum record length, automatic measurement of waveform parameters cannot be performed on calculated waveforms. ***** is displayed for the measured results.

9.5 Adding, Subtracting, and Multiplying Waveforms

<For a description of this function, see page 1-24>

Relevant Keys

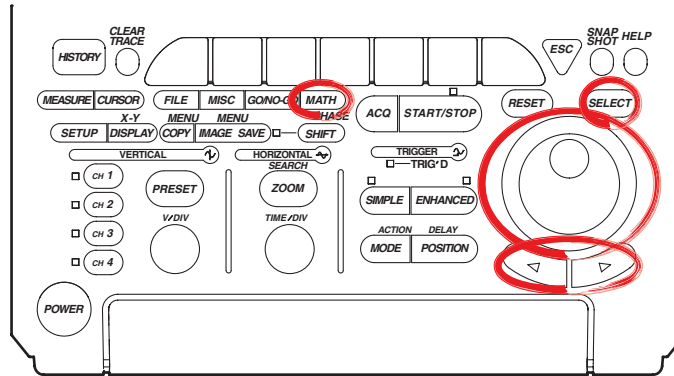

Operating Procedure

Turn ON/OFF the display

1. Press **MATH**.
2. Press the **M1 Display** soft key and select ON to display Math1 and OFF to not display M1.

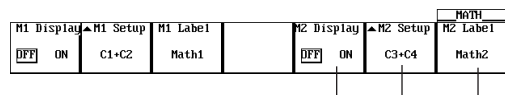

Math2 is not available on the DL1620, so these soft keys are not displayed.

Setting the Operator

3. Press the **M1 Setup** soft key to display the computation dialog box.
4. Turn the jog shuttle to move the cursor to Source1.

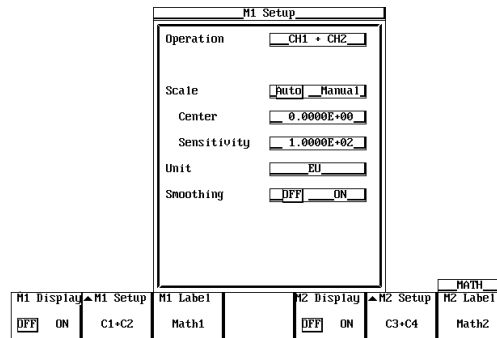

5. Press **SELECT** to display the operator setting menu.
6. Turn the jog dial to select CH1+CH2, CH1-CH2, or CH1*CH2, and press **SELECT**.

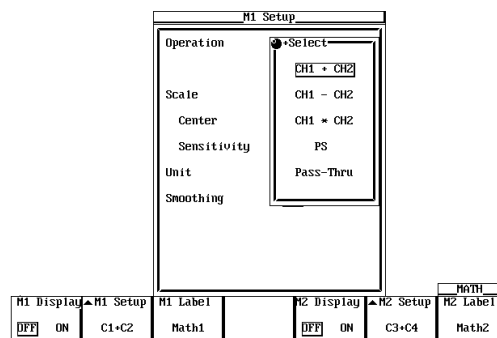

9.5 Adding, Subtracting, and Multiplying Waveforms

Scaling

- Turn the jog shuttle to move the cursor to Scale.
- Press **SELECT** to select Auto or Manual. If you select Auto, go to step 15.
- If you selected Manual, turn the jog shuttle to move the cursor to Center.
- Press **SELECT** to display a menu used to set the position of the center in the waveform display.
- Turn the jog shuttle to set the position of the center and press **SELECT**.
- Turn the jog shuttle to move the cursor to Sensitivity.
- Press **SELECT** to display the menu used to set values in 1-div increments.
- Turn the jog shuttle to set values in 1-div increments and press **SELECT**.

Note

If you set Center of Sensitivity after setting Scale to Auto, Scale automatically reverts to Manual.

Setting the Unit

- Turn the jog shuttle to move the cursor to Unit.
- Using the keyboard that appears when **SELECT** is pressed enter the unit using four characters or less.

Smoothing

- Turn the jog shuttle to move the cursor to Smoothing.
- Press **SELECT** to select ON or OFF.

Note

For details regarding smoothing, see section 9.7, "Smoothing."

Entering Labels

- Press the **M1 Label** soft key to display the keyboard, then enter a label. See section 8.5, "Setting the Waveform Labels" for information about displaying labels.

Set Math2 in a similar manner as necessary.

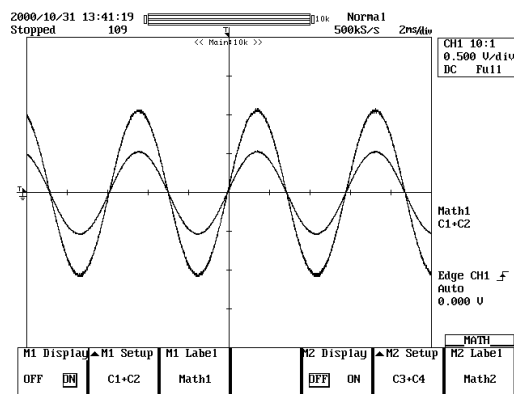

Explanation

Addition, subtraction, and multiplication can be performed between the following channels.

Math1: CH1 + CH2 only

Math2: CH3 + CH4 only (DL1640/DL1640L only)

Math1 and Math2 can be computed simultaneously.

+ Computed Waveform

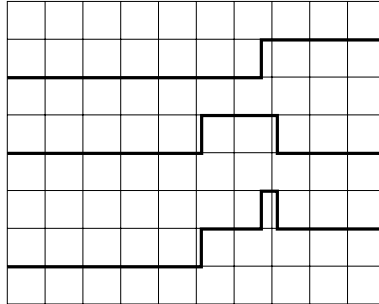

- Computed Waveform

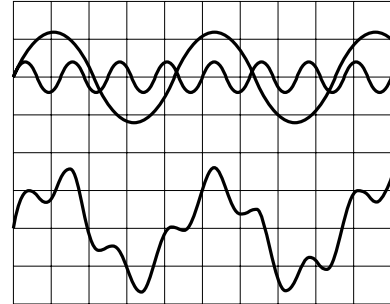
**Scaling**

Set the upper and lower limits on computations.

Auto: The Center and Sensitivity are set according to the computed result.

Manual: The Center and Sensitivity can be set arbitrarily. The range is $-9.9999E+30$ to $9.9999E+30$.

Unit

Unit can be set arbitrarily using up to four characters. The specified characters are reflected in the scale values.

Smoothing

See section 9.7, "Smoothing."

About Linear Scaling

When performing computation on a channel that has linear scaling set, the computation is performed on the scaled value.

9.6 Displaying the Power Spectrum

<For a description of this function, see page 1-25>

Relevant Keys

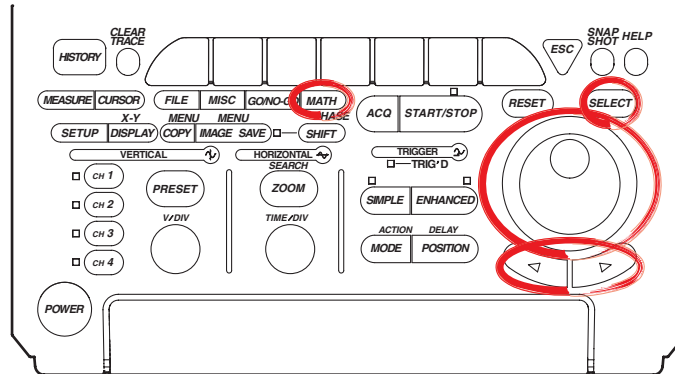

Operating Procedure

Turning ON/OFF the Display

1. Press **MATH**.
2. Press the **M1 Display** soft key and select ON to display Math1 and OFF to not display Math1.

M1 Display			M1 Setup			M1 Label			M2 Display			M2 Setup			M2 Label			MATH		
OFF	ON	C1+C2	Math1			OFF	ON	C3+C4	Math2											

Math2 is not available on the DL1620, so these soft keys are not displayed.

Setting the Operator

3. Press the **M1 Setup** soft key to display the computation dialog box.
4. Turn the jog shuttle to move the cursor to Operation.

M1 Setup																				
Operation <input type="text" value="CH1 + CH2"/>																				
Scale <input type="text" value="Auto Manual"/>																				
Center <input type="text" value="0.0000E+00"/>																				
Sensitivity <input type="text" value="1.0000E+02"/>																				
Unit <input type="text" value="dB"/>																				
Snoothing <input type="text" value="OFF ON"/>																				
M1 Display			M1 Setup			M1 Label			M2 Display			M2 Setup			M2 Label			MATH		
OFF	ON	C1+C2	Math1			OFF	ON	C3+C4	Math2											

5. Pressing **SELECT** displays the operator setting menu.
6. Turn the jog shuttle to select PS and press **SELECT**.

M1 Setup																				
Operation <input type="text" value="Select"/>																				
Scale <input type="text" value="CH1 + CH2"/>																				
Center <input type="text" value="CH1 - CH2"/>																				
Sensitivity <input type="text" value="CH1 * CH2"/>																				
Unit <input type="text" value="PS"/>																				
Snoothing <input type="text" value="Pass-Thru"/>																				
M1 Display			M1 Setup			M1 Label			M2 Display			M2 Setup			M2 Label			MATH		
OFF	ON	C1+C2	Math1			OFF	ON	C3+C4	Math2											

Selecting the Channel on which to Perform Computation

7. Turn the jog shuttle to move the cursor to Source.
8. Pressing **SELECT** displays the channel setting menu.
9. Turn the jog shuttle to select the channel on which to perform computation and press **SELECT**.

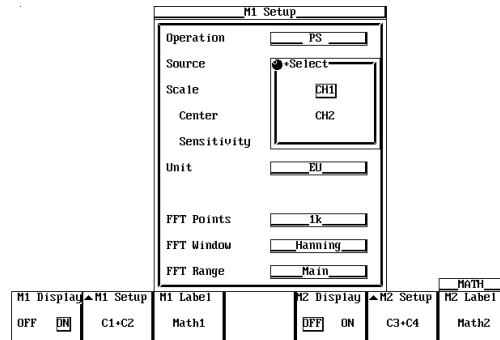
**Scaling**

10. Turn the jog shuttle to move the cursor to Scale.
11. Press **SELECT** to select Auto or Manual. If you select Auto, go to step 18.
12. If you selected Manual, turn the jog shuttle to move the cursor to Center.
13. Press **SELECT** to display a menu used to set the position of the center in the waveform display.
14. Turn the jog shuttle to set the position of the center and press **SELECT**.
15. Turn the jog shuttle to move the cursor to Sensitivity.
16. Press **SELECT** to display the menu used to set values in 1-div increments.
17. Turn the jog shuttle to set values in 1-div increments and press **SELECT**.

Setting the Unit

18. Turn the jog shuttle to move the cursor to Unit.
19. Using the keyboard that appears when **SELECT** is pressed enter the unit using four characters or less.

9.6 Displaying the Power Spectrum

Setting the Number of FFT Points

20. Turn the jog shuttle to move the cursor to FFT Points.
21. Pressing **SELECT** displays a menu used to select the number of points on which to take the FFT.
22. Turn the jog shuttle to select 1 k or 10 k and press **SELECT**.

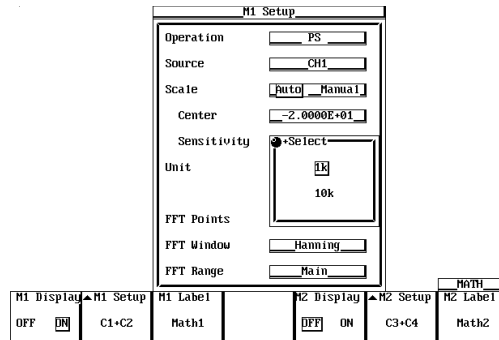

Selecting the Time Window

23. Turn the jog shuttle to move the cursor to FFT Window.
24. Pressing **SELECT** displays the time window menu.
25. Turn the jog shuttle to select Rect, Hanning, or FlatTop and press **SELECT**.

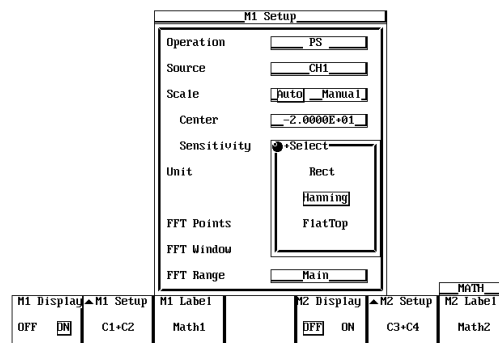

Setting the FFT Range

26. Turn the jog shuttle to move the cursor to FFT Range.
27. Pressing **SELECT** displays a menu used to select the calculation range.
28. Turn the jog shuttle to select Main, Zoom1, or Zoom2 and press **SELECT**.

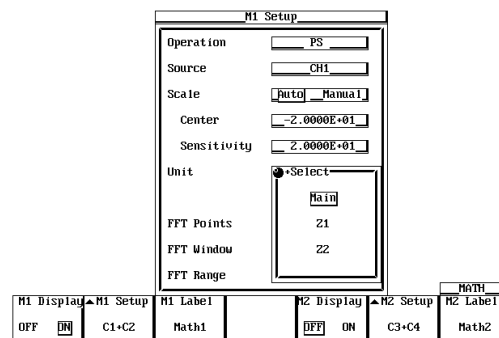

Entering Labels

29. Press the **M1 Label** soft key to display the keyboard. See section 8.5, “Setting the Waveform Labels” for information about displaying labels.

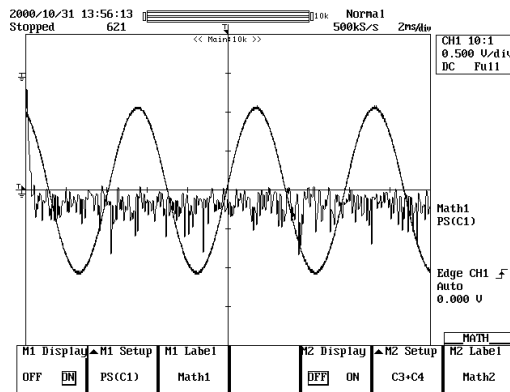
**Explanation**

This function displays the power spectrum of CH1 to CH4 and Math1 (or CH1, and CH2, and Math1 on the DL1620) waveforms.

Number of Computing Points: Point

Select 1 k or 10 k.

If the record is longer than the total number of computing points, the data is thinned to match the number of computing points, then FFT is performed.

Selecting the Time Window: Window

Select from the following windows.

Rect (Rectangular): Best suited for transient signals that attenuate completely within the time window.

Hanning (Hanning): Best suited for continuous and non-periodic signals.

Flattop (Flat Top): Best suited for improve the accuracy of the level even if the frequency resolution is to be compromised.

Power Spectrum Calculation Range

You can select the power spectrum calculation range from the following choices.

- Main:** Calculate using the range displayed on the main screen
- Zoom1:** Calculate using the range displayed on the Zoom1 screen
- Zoom2:** Calculate using the range displayed on the Zoom2 screen

Note

- If you perform the calculation with the range set to Zoom1 or Zoom2, when zooming the calculation results you must use a zoom screen with no calculation range selected.
- You can zoom the calculation results so that up to 500 data are displayed.

Notes when Displaying Power Spectrums

- Cannot be executed if the displayed record length is less than number of computation points (Point).

9.7 Smoothing

Relevant Keys

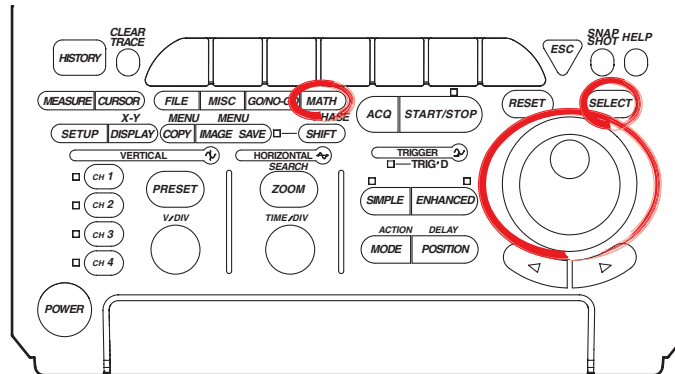

Operating Procedure

Turning ON/OFF the Display

1. Press **MATH**.
2. Press the **M1 Display** soft key and select ON to display Math1 and OFF to not display Math1.

M1 Display			M1 Setup			M1 Label			M2 Display			M2 Setup			M2 Label		
OFF	ON		C1+C2			Math1			OFF	ON		C3+C4			Math2		

Math2 is not available on the DL1620, so these soft keys are not displayed.

Setting the Operator

3. Press the **M1 Setup** soft key to display the computation dialog box.

M1 Setup																	
Operation: CH1 + CH2																	
Scale: Auto																	
Center: 0.0000E+00																	
Sensitivity: 1.0000E+02																	
Unit: EU																	
Smoothing: OFF ON																	

M1 Display			M1 Setup			M1 Label			M2 Display			M2 Setup			M2 Label		
OFF	ON		C1+C2			Math1			OFF	ON		C3+C4			Math2		

To smooth the measured data, set Operation to Pass-Thru.

M1 Setup																	
Operation: *Select																	
Source: CH1 + CH2																	
Scale: CH1 - CH2																	
Center: CH1 * CH2																	
Sensitivity: PS																	
Unit: Pass-Thru																	
Smoothing:																	

M1 Display			M1 Setup			M1 Label			M2 Display			M2 Setup			M2 Label		
OFF	ON		C1+C2			Math1			OFF	ON		C3+C4			Math2		

Note

If an operator other than Through is selected, the computation is performed on the smoothed value.

Smoothing

4. Turn the jog shuttle to move the cursor to Smoothing.
5. Press **SELECT** to select ON.

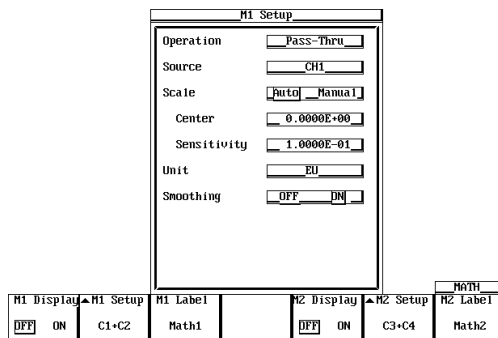

Explanation

The moving average is determined every five data samples, and the waveform is displayed based on the results. Since this process is performed on the data stored in the acquisition memory, it can be executed even when the waveform acquisition is stopped. This smoothing process has the following frequency characteristics with respect to the sample rate. The -3 dB point is at approximately 13% of the sample rate.

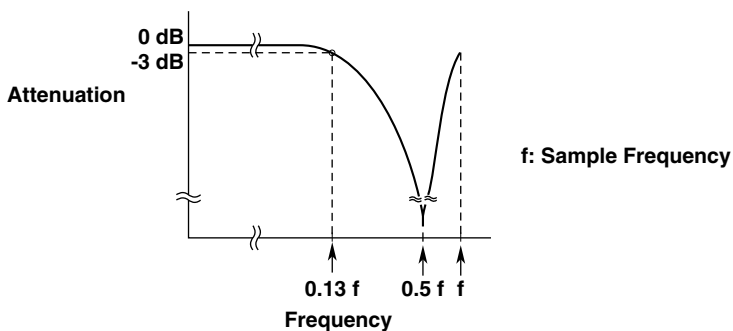

9.8 Phase-Shifted Display

<For a discription of this function, see page 1-24>

Relevant Keys

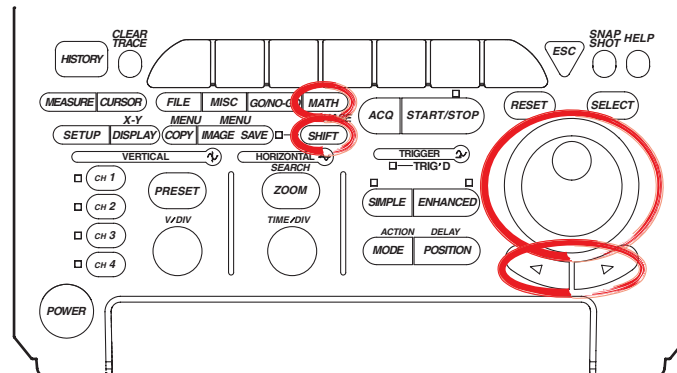

Operating Procedure

Setting the Computation Mode

1. Press **SHIFT** to activate shift mode.
Functions marked in purple on the panel become active.
2. Press **MATH**.
3. Press the **Mode** soft key to select ON or OFF.

Mode	CH1	CH2	CH3	CH4	PHASE
OFF	ON	0.000°	0.000°	0.000°	0.000°

These soft keys are not displayed on the DL1620.

4. Press the soft key corresponding to the channel whose phase is to be shifted.
5. Turn the jog shuttle to set the shifted time.

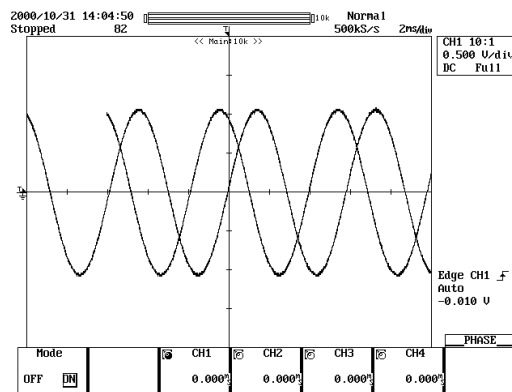

Explanation

The phase of CH1 to CH4 (or CH1 to CH2 for the DL1620) waveforms is shifted and the result is displayed. Computation can also be carried out on phase-shifted waveforms.

Allowable Shift Range

The phase can be shifted in the following range.

Time value between $-(\text{record length}/2)$ to $(\text{record length}/2)$ (resolution: $1/\text{sample rate}$)

The sample rate varies depending on the record length or T/div setting. For details, see Appendix 1, "Relationship between the Time Axis Setting, Sample Rate, and Record Length."

Notes when Shifting the Phase

If you change the T/div setting after shifting the phase, the shift on the screen does not change, but the specified time value change in accordance with the T/div setting.

9.9 GO/NO-GO Determination Using the Measurement of Waveform Parameters

<For a description of this function, see page 1-33>

Relevant Keys

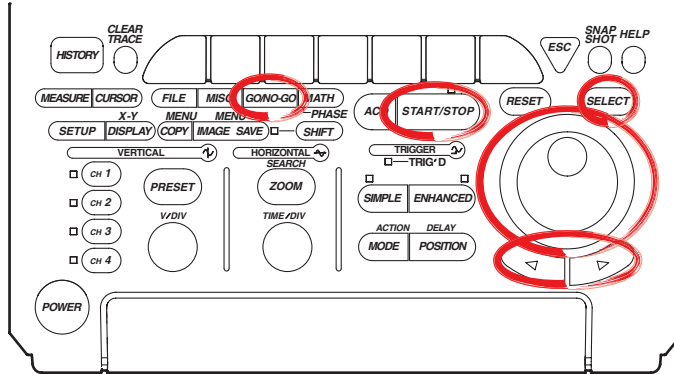

Operating Procedure

Setting the Mode

1. Press **GO/NO-GO**.
2. Pressing the **Mode** soft key displays a menu used to set the GO/NO-GO determination mode.

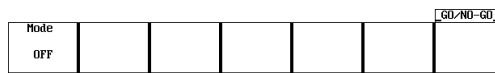

3. Press the **Parameter** soft key to set the GO/NO-GO determination mode.

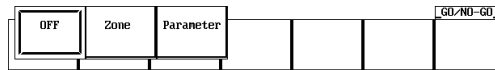

Setting Param1

4. Pressing the **Setup** soft key displays the determination criteria menu.

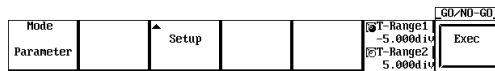

5. Turn the jog shuttle to move the cursor to Mode under Param1.

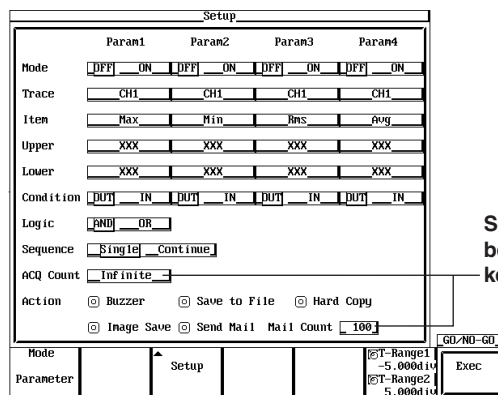

Settings for the following items can be input directly using a USB keyboard. (Ⓜ)

9.9 GO/NO-GO Determination Using the Measurement of Waveform Parameters

6. Press **SELECT** to select ON or OFF. If OFF is selected, Param1 will be excluded from the determination criteria.
7. Turn the jog shuttle to move the cursor to Trace.
8. Pressing **SELECT** displays the channel menu.
9. Turn the jog shuttle to select the channel and press **SELECT**. (CH3, CH4, and Math2 are not displayed on the DL1620.)

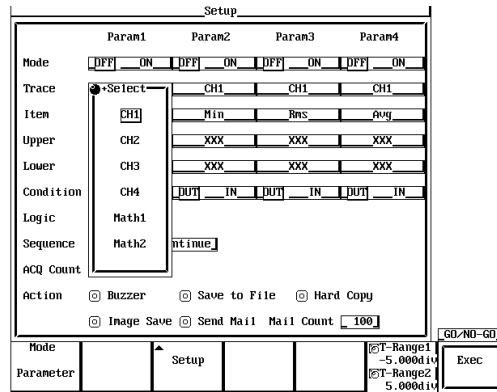

10. Turn the jog shuttle to move the cursor to Item.
11. Pressing **SELECT** displays the automated measurement item menu.

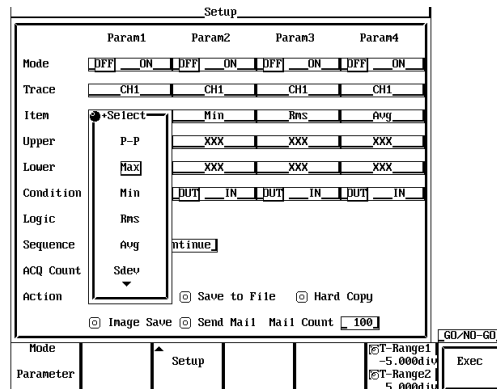

12. Turn the jog shuttle to select the item and press **SELECT**.

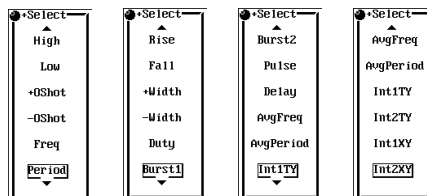

13. Turn the jog shuttle to move the cursor to Upper.
14. Pressing **SELECT** displays the upper limit setting menu.
15. Turn the jog shuttle to select the upper limit and press **SELECT**.
16. Set Lower in a similar fashion.
17. Turn the jog shuttle to move the cursor to Condition.
18. Press **SELECT** to select IN or OUT.
19. Set Param2 to Param4 as necessary.

Setting the Logic

- 20. Turn the jog shuttle to move the cursor to Logic.
- 21. Press **SELECT** to select AND or OR.

Setting the Sequence

- 22. Turn the jog shuttle to move the cursor to Sequence.
- 23. Press **SELECT** to select Single or Continue.

Setting the ACQ Count

- 24. Turn the jog shuttle to move the cursor to ACQ Count.
- 25. Pressing **SELECT** a menu used to set the number of waveform acquisitions.
- 26. Turn the jog shuttle to set the number of waveform acquisitions and press **SELECT**.

Selecting the Action to Take when the Condition is not Met

- 27. Turn the jog shuttle to move the cursor to Action.
- 28. Press **SELECT** to turn the action ON or OFF.

Setting the Determination Range

- 29. Press the **T-Range1/T-Range2** soft key to set the jog shuttle control to T-Range1.
- 30. Turn the jog shuttle to set the start point of the determination range.
- 31. In a similar fashion, set the end point of the determination range with T-Range2.

Executing the GO/NO-GO Determination

- 32. Press the **Exec** soft key to execute the GO/NO-GO determination.

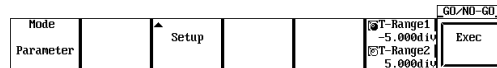

When the determination terminates, the waveform acquisition is automatically stopped.

To forcibly stop the operation, press **START/STOP** or the **Abort** soft key to stop the acquisition.

Explanation

Waveform Parameters that can be Determined using GO/NO-GO Operation: Item

This function is applicable to the all of waveform parameters (27 items) in section 9.2. Up to four types of parameters can be determined simultaneously.

Mode

- OFF: Does not perform GO/NO-GO determination
- ON: Performs GO/NO-GO determination

Upper and Lower Limits of Parameters: Upper/Lower

The upper and lower limits depends on the parameters. They can be set in the range – 9.9999E+30 to 9.9999E+30.

Setting the Condition

- IN: When the value is inside the upper and lower limits.
- OUT: When the value is outside the upper or lower limits.

Setting the Logic

AND: Executes the Action when all parameter conditions (1 to 4 types) are met.

OR: Executes the Action when any one of the parameter conditions (1 to 4 types) is met.

Action to Take when the Condition is Met (not Met): Action

Buzzer: Sounds the buzzer.

Save to File: Saves the waveform data to the storage medium (Internal flash memory, FD, Zip disk, PC card, USB storage, or network drive) specified in the FILE menu.

Hard Copy: Outputs the screen image data to the destination (Built-in, USB, Net Print (Ethernet interface option)) specified by Copy to in the Copy setting menu.

Image Save: Saves the screen image data to the output destination (Internal flash memory, FD, Zip disk, PC card, USB storage, or network drive) that you specified in the Image Save menu.

Send Mail: Sends a mail (Ethernet Interface option). For details, see section 13.7, "Using the Mail Function (Action Mail Function)."

Number of Actions: Sequence

Single: Executes the Action once and terminates.

Continue: Repeats the execution of the Action up to the number of acquisition count specified in ACQ Count (until the acquisition is stopped if infinite is specified).

Number of Waveform Acquisitions: ACQ Count

Set the number of waveform acquisitions.

Infinite: Continues until the waveform acquisition is stopped with **START/STOP**.

1 to 65536: Stops when the specified number of waveforms is acquired.

Executing/Aborting GO/NO-GO Operation

The operation starts when you press the **Exec** soft key. Waveform acquisition is automatically stopped when the determination is complete. To forcibly stop the operation, press **START/STOP** or press the **Abort** soft key.

Save to File/Hard Copy/Image Save Operation

Operates according to the settings in the File menu, the Copy menu, or the Image Save menu.

File Name when Action is Set to Save to File or Image Save

The file is saved with AutoName under the File menu or the Image Save menu. For details, see section 10.4, "Storing Screen Image to the External Storage Medium" or section 11.6, "Saving/Loading Waveform Data."

Notes when Performing GO/NO-GO Determination

- The determination results (the number of successes and failures) are displayed.
- All keys other than **START/STOP** and the **Abort** soft key are disabled during the determination.
- When GO/NO-GO determination is executed, the trigger mode is automatically changed to Single.
- Determination is not possible when the acquisition mode is set to Average.

9.10 GO/NO-GO Determination Using Zones

<For a discription of this function, see page 1-33>

Relevant Keys

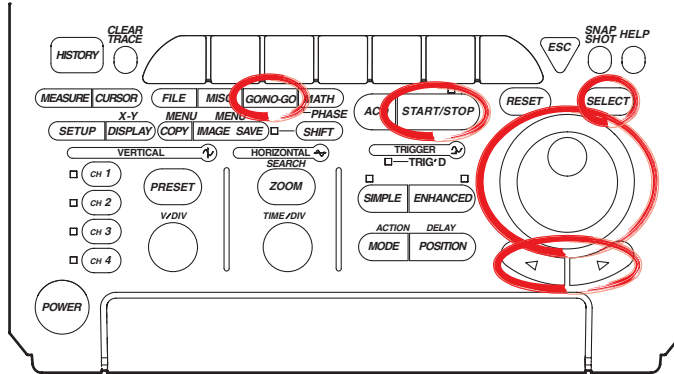

Operating Procedure

Setting the Mode

1. Press **GO/NO-GO**.
2. Press the **Mode** soft key to display the GO/NO-GO determination mode setting menu.

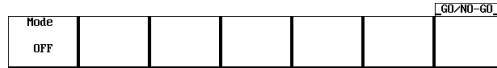

3. Press the **Zone** soft key to set the GO/NO-GO determination mode.

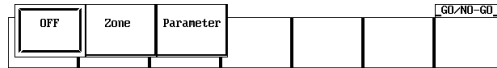

Creating a Determination Zone

4. Press the **Edit Menu** soft key.

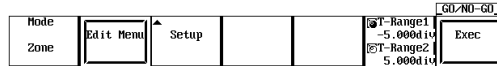

5. Press the **New** soft key to display the zone creation reference waveform selection menu.



6. Press the soft key corresponding to the reference waveform to display the zone editing menu. (CH3, CH4, and Math2 are not displayed on the DL1620.)

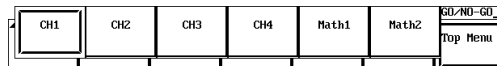

9.10 GO/NO-GO Determination Using Zones

Editing All Zones

7. When Edit is set to something other than Whole, press the **Edit** and select Whole.

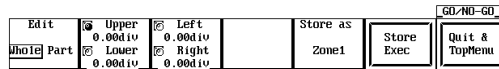

8. Press the **Upper/Lower** or **Left/Right** soft keys to select the zone setting direction.
 9. Turn the jog shuttle to create a zone.
 10. Repeat steps 8 and 9 to edit the zones.
 11. Press the **Store as** soft key to open the store as setting menu for the edited zone.
 12. Press the soft key corresponding to a storage location **Zone1 - Zone6** (or **Zone1 - Zone3** for the DL1620) to select it.

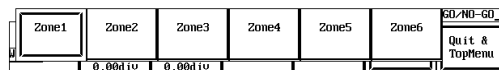

13. Press the **Store Exec** soft key to save the zone. Proceed to step 14 to edit a partial zone, or skip to step 22 to quit.

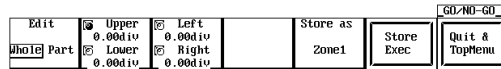

Editing a Partial Zone

14. Press the **Edit** soft key to select Part.

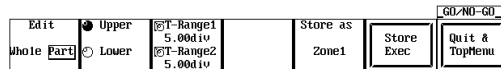

15. Press the **T-Range1/T-Range2** soft key to select the right or left cursor.
 16. Turn the jog shuttle to set the right and left edges of the partial zone.
 17. Press the **Upper/Lower** soft key to select the direction for setting the zone, then use the jog shuttle to create the zone.
 18. Repeat steps 15-17 to edit the zone.
 19. Press the **Store as** soft key to open the store as setting menu for the edited zone.
 20. Press the soft key corresponding to a storage location **Zone1 - Zone6** (or **Zone1 - Zone3** for the DL1620) to select it.

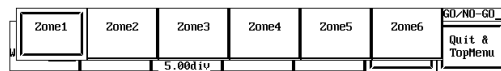

21. Press the **Store Exec** soft key to save the zone.

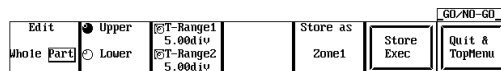

Quit Zone Editing

22. Press the **Quit & TopMenu** soft key to return to the menu in step 3. If you press the **Quit & TopMenu** soft key before pressing the **Store Exec** soft key, the settings made up to that point will be inactive, and you will return to the menu in step 3.

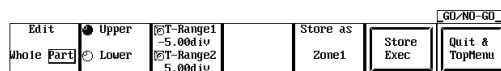

Editing Existing Zones

Edit zones that have been previously created.

- 23. In step 5, press the **Redraw** soft key.
- 24. Repeat steps 6-22 to edit the zones.

Selecting a Determination Waveform

- 25. Press the **Setup** soft key to display the Setup menu.
- 26. Turn the jog shuttle to move the cursor to Trace of Zone1.

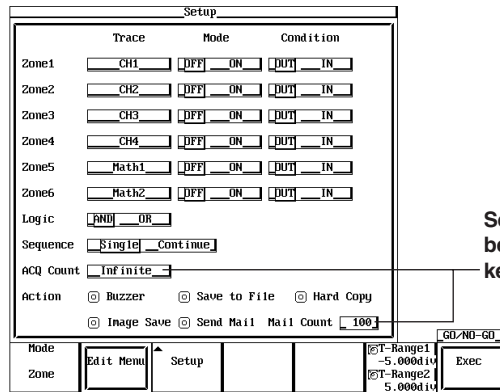

- 27. Press **SELECT** to select CH1 through CH4, Math1, or Math2 (or CH1, CH2, or Math1 for the DL1620).

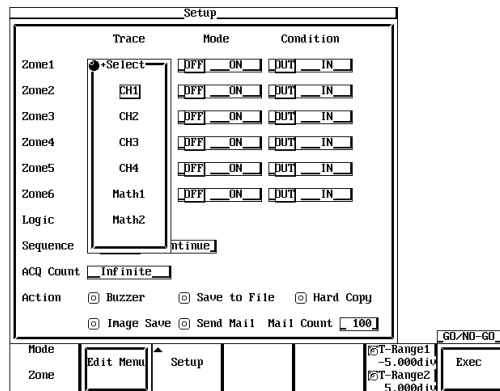

- 28. Use the jog shuttle to move the cursor to Mode under Zone1.
- 29. Press **SELECT** to select On or Off.
- 30. Use the jog shuttle to move the cursor to Condition under Zone1.
- 31. Press **SELECT** to select In or Out.
- 32. Set Zone2 - Zone6 (or Zone2 - Zone3 for the DL1620) as necessary.

Setting the Logic

- 33. Move the cursor to Logic with the jog shuttle.
- 34. Press **SELECT** to select AND or OR.

Setting the Sequence

- 35. Use the jog shuttle to move the cursor to Sequence.
- 36. Press **SELECT** to select Single, or Continue.

Setting the ACQ Count

37. Use the jog shuttle to move the cursor to ACQ Count.
38. Press **SELECT** to display the waveform acquisition count setting menu.
39. Use the jog shuttle to set the waveform acquisition count, then press **SELECT**.

Selecting the Action for Condition not Met

40. Use the jog shuttle to move the cursor to Action.
41. Press **SELECT** to turn action ON or OFF.

Setting the Determination Range

42. Press the **T-Range1/T-Range2** soft key to highlight the T-Range1 jog shuttle icon.
43. Use the jog shuttle to set the head of the determination range.
44. In the same manner, set the tail of the range to T-Range2.

Executing Determination

45. Press the **Exec** soft key to execute the determination. The **Exec** changes to the **Abort** soft key. When the determination is completed, acquisition automatically stops. You can force a stop by pressing **START/STOP** or the **Abort** soft key.

Explanation

Create zones using a standard waveform as a base, and from those zones let GO/NO-GO be determined by whether a waveform extends outside or inside of the zone.

Waveform for GO/NO-GO Determination/Determination criteria: Setup

You can select a waveform from input signals (CH1-CH4 (or CH1 and CH2 for the DL1620)) and from math waveforms (Math1, Math2 (or Math1 only for the DL1620)). You can use multiple waveforms for GO/NO-GO determination. Select from the following determination standards for each waveform:

- IN: When the specified waveform enters the zone.
- OUT: When the specified waveform is outside the zone.
- OFF: Do not determine.

Selecting the Reference Waveform: Edit Menu

Select a reference waveform for creating a zone. The basic waveform will be displayed as a trace, and you can select from the following types.

- Input signal waveform
- Math waveform

Creating a Determination Zone: Redraw/New

You can set up to six (or three for the DL1620) determination zones. The following are the setting ranges.

- Up-down setting range: ± 8 div from the reference waveform
- Left-right setting range: ± 5 div from the center of the screen

You can select input signal waveforms (CH1 through CH4 (or CH1 and CH2 for the DL1620)) and computed waveforms (Math1 and Math2 (or Math1 only for the DL1620)) for the waveforms that are to be determined in the determination zones that are registered in Zone1 through Zone6.

The screen displays the active zones depending on the settings in Setup.

Setting Logic

AND: When all parameter conditions 1 - 6(1 - 4 for the DL1620) are met, GO/NO-GO Action is performed

OR: When at least one parameter condition from 1 - 6(1 - 4 for the DL1620) are met, GO/NO-GO Action is performed

Action to Take when the Condition is Met (not Met): Action

Buzzer: Sounds the buzzer.

Save to File: Saves the waveform data to the storage medium (Internal flash memory, FD, Zip disk, PC card, USB storage, or network drive) specified in the FILE menu.

Hard Copy: Outputs the screen image data to the destination (Built-in, USB, Net Print (Ethernet interface option)) specified by Copy to in the Copy setting menu.

Image Save: Saves the screen image data to the output destination (Internal flash memory, FD, Zip disk, PC card, USB storage, or network drive) that you specified in the Image Save menu.

Send Mail: Sends a mail (Ethernet Interface option). For details, see section 13.7, "Using the Mail Function (Action Mail Function)."

Action Count: Sequence

Single: Conclude after one instance of the Action.

Continue: Repeat the Action the number of times specified as the sampling count in ACQ Count (if set to Infinite, Action repeats until determination stops).

Waveform Sampling Count: ACQ Count

Set the waveform sampling count.

Infinite: Sampling continues until determination stops, or until **START/STOP** or **Abort** soft key is pressed.

1-65536: Sampling stops after the specified count has been reached.

Start/Stop GO/NO-GO Determination

Press the **Exec** soft key to execute the determination. Determination will stop automatically when finished, or you can press **START/STOP** or **Abort** soft key to force a stop.

Save to File/Hard Copy/Image Save Operation

Operates according to the settings in the File menu, the Copy menu, or the Image Save menu.

File Name when Action is Set to Save to File or Image Save

The file is saved with AutoName under the File menu or the Image Save menu. For details, see section 10.4, "Storing Screen Image to the External Storage Medium" or section 11.6, "Saving/Loading Waveform Data."

Notes about GO/NO-GO Determination

Determination results (number of successes, failures) are displayed on screen.

Functions other than **START/STOP** and **Abort** soft key are inactive during determination.

When performing GO/NO-GO determination, the trigger mode is automatically set to Single.

Determination is not possible when acquisition mode is set to Average.

Note

The zone waveform that you created is stored as setting information onto the floppy disk, Zip disk, PC card, USB storage, or the internal flash memory.

9.11 Using the GO/NO-GO Signal Output Function

Output Signal

NO-GO OUT Signal

The output signal level (TTL level) changes from high(H) to low (L) temporarily when a NO-GO determination is made.

GO OUT Signal

The output signal level (TTL level) changes from high (H) to low (L) temporarily when a GO determination is made.

Signal Output Circuit Diagram

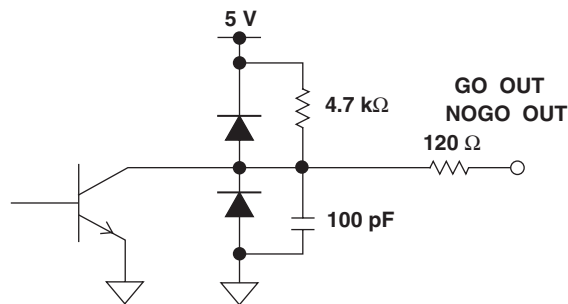

Output Connector

The format and pin arrangement of the output connector on the DL1620/DL1640/DL1640L are as follows:

- **Format**

The connector uses a modular jack (RJ12). Use the optional accessory 36973 (sold separately) for the cable. If you are using a commercially sold cable (4 contact modular cable for telephone circuits), wire the pins according to the following figure.

- **Pin Arrangement**

GO/NO-GO	Pin Number	Signal	Logic
 DL Side Connector	1	NC (Unconnected)	
	2	NC (Unconnected)	
	3	GO OUT	Negative
	4	NO-GO OUT	Negative
	5	GND	
	6	NC (Unconnected)	

Output Timing

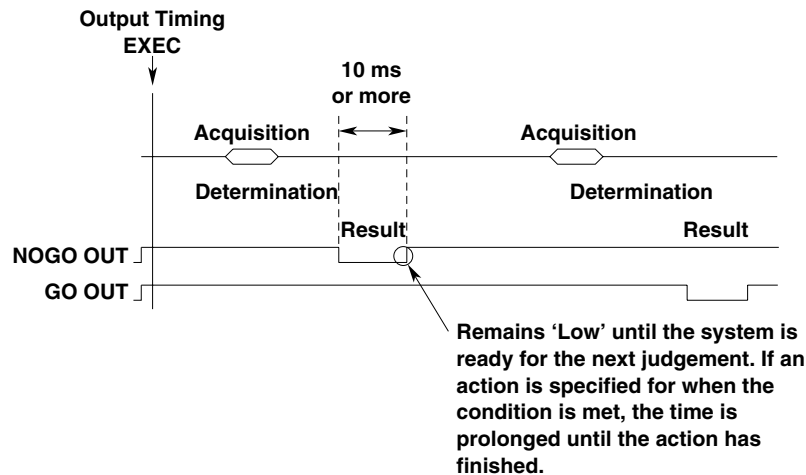

Connecting to Another Instrument

CAUTION

- Never apply an external voltage to the NO-GO OUT and GO OUT terminals, otherwise damage to the instrument may result.
- When connecting the GO/NO-GO signal output externally, make sure not to connect other signal pins by mistake. Errors in connection may cause damage to this instrument or to the other connected instrument.
- Do not mistakenly insert the USB cable to the GO/NO-GO output terminal. This may cause damage to the DL1620/DL1640/DL1640L.

To connect the DL1620/DL1640/DL1640L to external equipment, use the GO/NO-GO cable (366973, sold separately).

Do not use the GO/NO-GO cable (366973, sold separately) for any other purpose than for carrying out GO/NO-GO determination on the DL1620/DL1640/DL1640L.

- **About the GO/NO-GO Cable (366973, Sold Separately)**

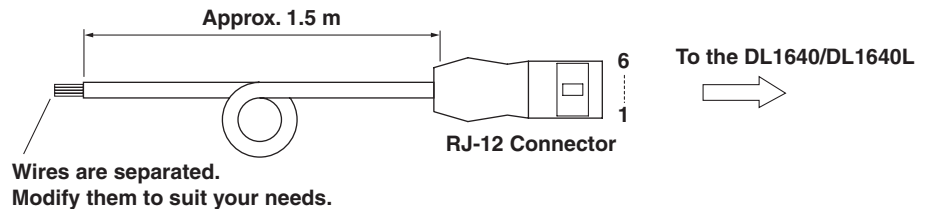

Color	Pin No.	Signal Name	Logic
Yellow	2	NC	
White	3	GO OUT	Negative
Green	4	NO-GO OUT	Negative
Blue	5	GND	

10.1 Loading the Paper Roll into the Built-in Printer (Option)

Printer Roll Chart

Use only YOKOGAWA roll chart. When you are using the printer for the first time, use the roll chart supplied with the instrument. When your roll charts have run out, purchase more from your dealer or YOKOGAWA sales offices listed on the back cover of this manual.

Part No.: B9850NX
Specification: Thermo-sensible, 30 m
Minimum Quantity: 5 rolls

Handling the Roll Chart

Thermosensible roll charts produce color using a thermal reaction, therefore the following precautions must be taken.

Storage Precautions

The roll chart begins to develop color at approximately 70°C. It is very sensitive to heat, damp, light and chemicals both before and after use.

- Keep roll charts in a dry, cool and dark place.
- Once the package is opened, use the roll chart as soon as possible.
- If the roll chart is left in contact with plastic films containing plasticizer (for instance, vinyl chloride film, cellophane tape etc.) for a long period of time, discoloration will occur on the recording area of the chart due to the plasticizer. If you are going to keep the roll chart in a holder, for instance, use a polypropylene holder.
- When you use adhesive on the roll chart, never use adhesive which contains an organic solvent such as alcohol or ether, otherwise color may develop on the chart.
- When you are going to store recorded roll charts for a long period of time, we suggest you make a copy of the charts since discoloration may occur.

Usage Precautions

- Use only YOKOGAWA genuine roll charts.
- Do not touch the roll chart with sweaty hands, otherwise it may become stained with your fingerprints, and information may be lost.
- Do not rub the surface of the roll chart strongly with a firm object, color development may occur due to frictional heat.
- Do not allow chemicals or oil to come into contact with the roll chart, otherwise color development or loss of information may result.

10.1 Loading the Paper Roll into the Built-in Printer (Option)

Operating Procedure

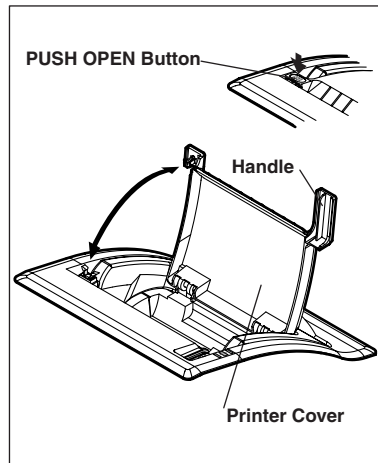

Press the PUSH OPEN button, and lift the handle on the right of the printer cover and open the cover.

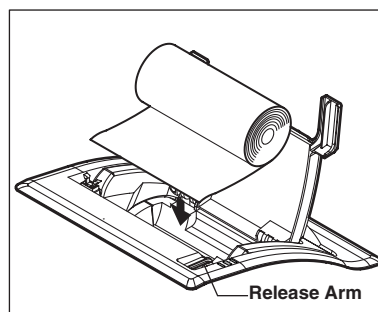

Move the release arm, located on the right near the front, to the MAN FEED position.

Have the inner side of the roll paper (the side that is not glossy) showing on top for the following procedure. Set the roll paper.

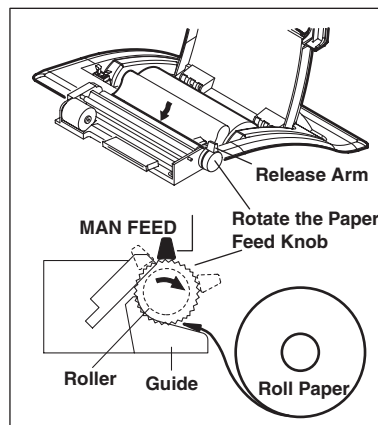

Insert the edge of the roll paper evenly in the space between the roller and the black guide, then rotate the paper feed knob in the direction of the arrow until about 10 cm of the roll sheet is showing from the top of the roller.

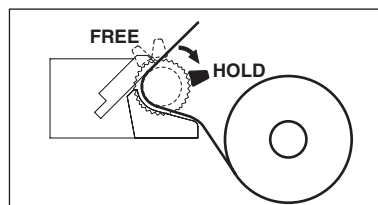

Move the release arm to the FREE position and straighten out the roll sheet. Then, move the release arm to the HOLD position.

The printing will fail with an error message, if the release arm is in the FREE or MAN FEED position during operation.

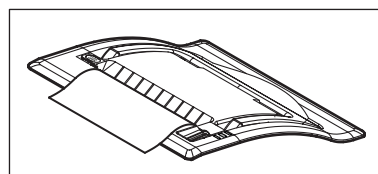

Pull the printer cover back to its original position and close the cover. Make sure that the edge of the roll sheet is showing from the opening of the printer cover.

Push the printer cover down firmly until it clicks into place.

Note

After loading the roll paper, the paper feed may be unstable. Print out 2 or 3 screen images before using the printer in your work.

10.2 Outputting Screen Image Data to the Built-in Printer (Option)

Relevant Keys

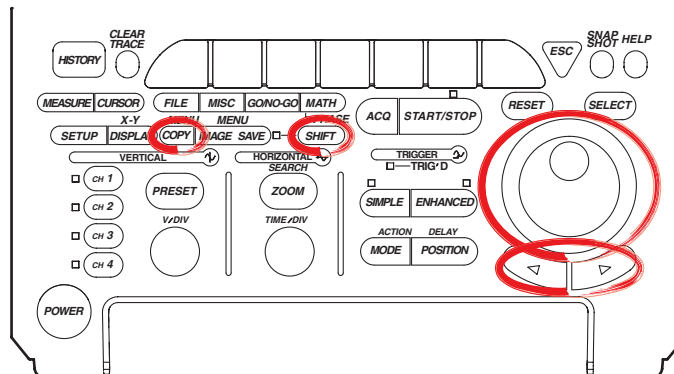

Operating Procedure

Selecting the Printer

1. Press **SHIFT** to activate shift mode.
Functions marked in purple on the panel become active.
2. Press **COPY**.
3. Pressing the **Copy to** soft key displays the output medium menu.

Copy to	Format	Information	Comment			COPY
Built-in	Normal Long	OFF ON				

4. Press the **Built-in** soft key. (USB is displayed only when the USB option is installed. Net Print is displayed only when the USB option or the Ethernet interface option is installed.)

Copy to	Format	Information	Comment			COPY
Built-in	USB	Net Print				

Setting the Output Format

5. Press the **Format** soft key to select Normal or Long.

Copy to	Format	Information	Comment			COPY
Built-in	Normal Long	OFF ON				

6. Press the **Information** soft key to select ON or OFF.

Setting Comments

7. Pressing the **Comment** soft key displays a keyboard.
8. Enter comments according to the procedures described in section 4.1.

Setting the Magnification Ratio (When the Output Format is Set to Long)

9. If you selected Long in step 5, set the magnification ratio using the jog shuttle. Press the **Mag** soft key to set the jog shuttle control to Mag.

Copy to	Format	Information	Comment	Mag	T-Range1	T-Range2	COPY
Built-in	Normal Long	OFF ON		x 2	-5.000div	5.000div	Preview

10. Turn the jog shuttle to set the magnification ratio. The number of output pages is displayed according to the ratio.

10.2 Outputting Screen Image Data to the Built-in Printer (Option)

Setting the Output Range (When the Output Format is Set to Long)

11. If you selected Long in step 5, set the output range.
Press the **T-Range1/T-Range2** soft key to set the jog shuttle control to T-Range1.

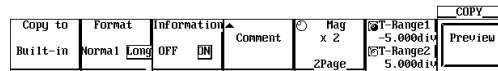

12. Turn the jog shuttle to set the start point of the output range.
13. In a similar fashion, set the end point of the output range in T-Range2.

Previewing (Long Copy)

14. Pressing the **Preview** soft key displays the output image on the screen.

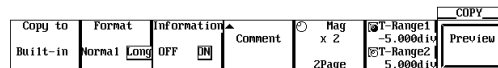

15. Turning the jog shuttle changes the displayed page.
16. Pressing the **Quit** soft key returns to the original screen.

Executing Print Out

17. Pressing **COPY** outputs a hard copy of the screen.
Pressing **COPY** again aborts the output.

Output Example when Mag is Set to Long

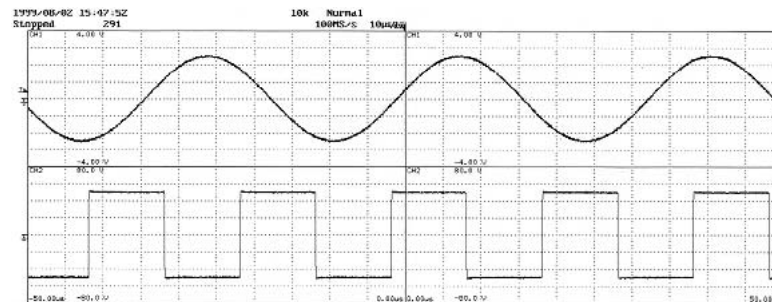

Explanation

Output Format

In addition to normal size, long copy is possible in which the time axis of the displayed waveform is magnified 2 to 800000 times before printing. The magnification ratio varies depending on the T/div and record length settings.

Outputting Optional Information

Outputs the results of the setup information at the same time as the waveform.

Comments

You can output a comment string consisting of up to 20 characters in the lower section.

Print Range

Sets the range to output to the printer from –5 div to 5 div .

Preview

The output image can be previewed using the specified output format.

Precautions to be Taken when Printing with the Built-in Printer

- Printing is not possible while the waveform acquisition is in progress.
- Only the main waveform is long copied.
- When displaying a waveform using the history memory function, only the waveform selected for Selected Record No. is long copied.
- Long copy is not possible when displaying X-Y waveforms.
- Long copy of snapshot waveforms and accumulated waveforms is not possible.

10.3 Outputting Screen Image Data to a USB Printer (Option)

Relevant Keys

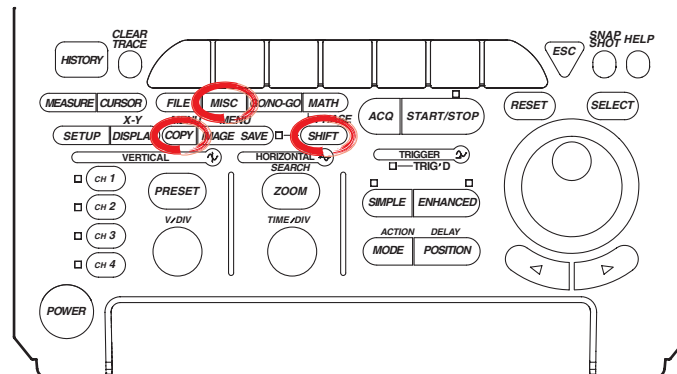

Operating Procedure

1. Connect the DL1620/DL1640/DL1640L and a USB printer using a USB cable. For details, see the explanation, page 10-8.

Confirming the Type of Printer that is Connected

To confirm the type of printer that is connected to the DL1620/DL1640/DL1640L, carry out the procedure below.

2. Press **MISC**.
3. Press the **Next 1/2** soft key.

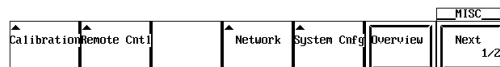

4. Press the **USB List** soft key to display the USB Device List. Check the printer that is connected.

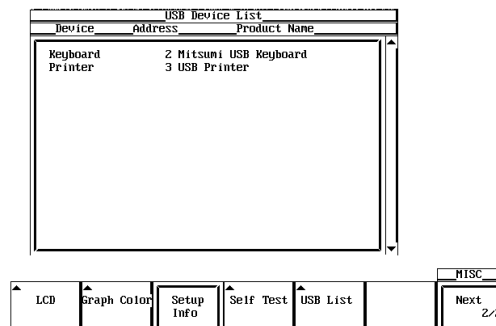

Selecting the Printer

5. Press **SHIFT** to activate shift mode. Functions marked in purple on the panel become active.
6. Press **COPY**.
7. Press the **Copy to** soft key to display the output medium selection menu.

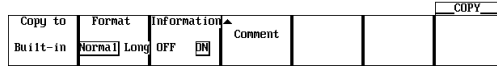

8. Press the **USB** soft key to select USB.

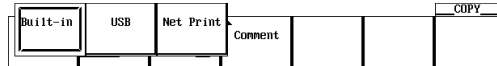

Selecting the Type

9. Press the **Format** soft key to display the menu used to select the output command type.

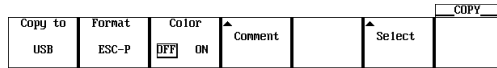

10. Press the soft key corresponding to the desired command type.

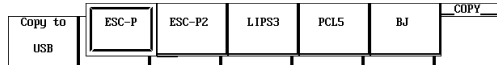

Setting the Color

11. Press the **Color** soft key to select ON or OFF.

Setting Comments

12. Press the **Comment** soft key. A keyboard appears on the screen.
13. Enter the comment string according to the procedure given in section 4.1.

Setting the Resolution (When Format is Set to BJ)

14. Press the **Resolution** soft key to display the resolution menu.

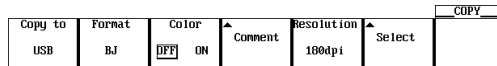

15. Press one of the soft keys corresponding to **180 dpi**, **300 dpi**, **360 dpi**, and **600 dpi** to set the resolution.

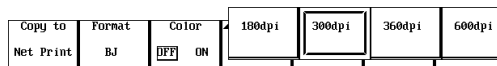

Executing Hard Copy

16. Press **COPY** to output a hard copy of the screen. Press **COPY** again to stop the output.

10.3 Outputting Screen Image Data to a USB Printer (Option)

Explanation

On the DL1620/DL1640/DL1640L, you can print the screen image data to a USB printer via the USB interface. You can also print the screen image to a network printer via the Ethernet network (when the Ethernet interface option is installed). For details, see section 13.5, "Sending Screen Image Data to a Network Printer"

USB PERIPHERAL Connectors

When connecting a USB printer to the DL1620/DL1640/DL1640L, connect a USB cable to the USB PERIPHERAL connector. There are two USB PERIPHERAL connectors.

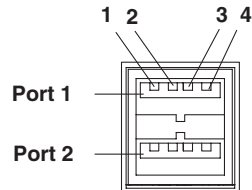

Pin No.	Signal Name
1	V _{BUS} : +5 V
2	D ⁻ : -Data
3	D ⁺ : +Data
4	GND: Ground

Printers that can be Used

USB printers conforming to USB Printer Class Ver. 1.0 that support the following output commands can be used.

Note

- Connect only the printers that are allowed.
 - For USB printers that have been tested for compatibility, contact your nearest YOKOGAWA dealer as listed on the back cover of this manual.
-

Format

You can select the type of command that is output to the USB printer from the following list of choices.

- ESC-P
- PCL5
- LIPS3
- ESC-P2
- BJ (can be used on models that support the BJC-35V native commands)
- ESC-PR (Applies to Firmware Version 1.44 or Later)

This is an output format for Seiko-Epson printers. If you choose this format you must select either Normal (for 4 x 6 printers) or Small (for Letter size printers).

Connection Procedure

When connecting a USB printer, directly connect the keyboard to the DL1620/DL1640/DL1640L with a USB cable as shown below. You can connect the USB cable regardless of the power ON/OFF state of the DL1620/DL1640/DL1640L (supports hot-plug). Connect the type A connector of the USB cable to the DL1620/DL1640/DL1640L; connect the type B connector to the printer. When the power switch is ON, the printer is detected and enabled approximately 6 seconds after it is connected.

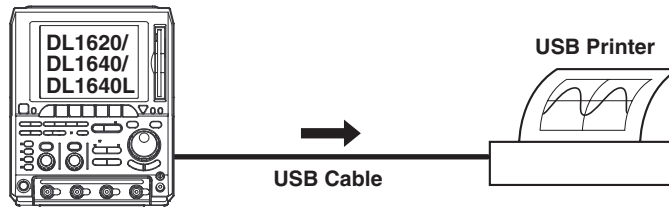

Note

- Connect the printer directly without going through a hub.
- Connect only a USB keyboard/USB printer/USB mouse/USB storage to the USB PERIPHERAL connectors.
- Do not connect multiple printers. You can connect a single printer, keyboard, and mouse.
- Never turn OFF the printer or remove the USB cable while the printer is printing.

Output Resolution when Printing using the BJ Format

When printing the screen image data to a USB BJ printer, select the output resolution from 180 dpi, 300 dpi, 360 dpi, and 600 dpi.

Comments

A comment string of up to 20 characters that is displayed at the lower right corner of the screen can be printed.

Color

Select from the following list of choices.

- ON: Prints the image using the same colors as the screen (no background color, grid printed in black).
- OFF: Prints the image using the same colors as the image printed using the built-in printer.

Precautions when Printing on a USB Printer

- Images may not print properly on some printers. Use USB printers that have been tested for compatibility.
For details on USB printers that have been tested for compatibility, contact your nearest YOKOGAWA dealer.
- You can also print to a USB printer that is connected to your PC. Save the screen image data to a floppy disk or a Zip disk according to the procedure given in section 10.4, "Storing Screen Image to the External Storage Medium." Then, load the data on the PC and print it.

Note

The DL1620/DL1640/DL1640L does not detect "out of paper" and printer errors on the USB printer. If you executed printing on the DL1620/DL1640/DL1640L when the USB printer is in such condition, press **COPY** to stop the printing.

10.4 Storing Screen Image Data to the External Storage Medium

Relevant Keys

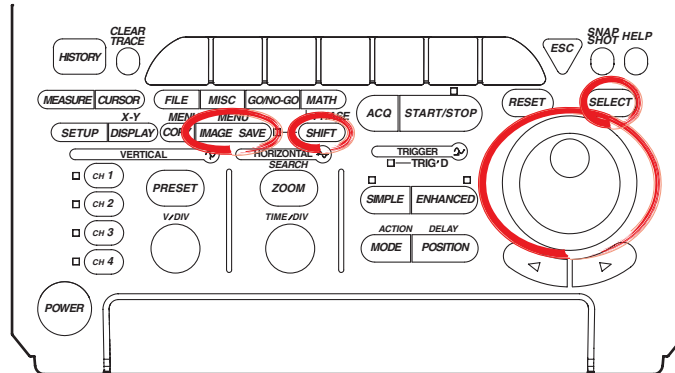

Operating Procedure

1. Press **SHIFT** to set the keys in the shifted condition. Functions marked in purple on the panel become active.
2. Press **IMAGE SAVE**.

Selecting the Format

3. Pressing the **Format** soft key.

Thumbnail	Format	Color	Comment	File List	IMAGE File Name
	TIFF	OFF			

4. Press the soft key corresponding to the type of format to be selected.

Thumbnail	TIFF	BMP	PS	PNG	JPEG	IMAGE File Name
						0000

Setting the Color (for formats other than PS)

5. Press the **Color** soft key to select **ON**, **ON(Revers)**, **ON(Gray)**, or **OFF**.

Thumbnail	Format	Color	Comment	File List	IMAGE File Name
	TIFF	OFF			

Setting Comments

6. Pressing the **Comment** soft key displays a keyboard.
7. Enter comments according to the procedures described in section 4.1.

Setting the Compression (for BMP (Color is ON))

8. Press the **Compression** soft key select **ON** or **OFF**. (When Compression is **ON**, you cannot store to Network Drive.)

Thumbnail	Format	Color	Comment	Compression	File List	IMAGE File Name
	BMP	ON		OFF ON		

Setting the Storing Destination

9. Pressing the **File List** soft key displays the output destination setting menu.
10. Turn the jog shuttle to select the save destination. The floppy disk, Zip disk, or PC card inserted in the built-in drive is displayed in brackets []. Directories are displayed in angle brackets < >.

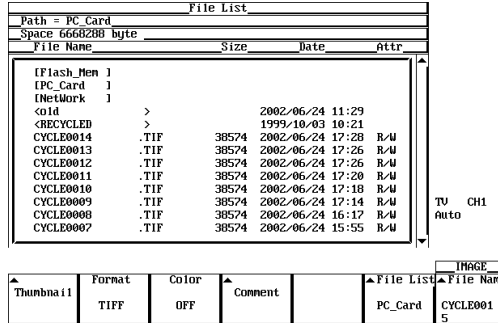

11. Pressing **SELECT** displays the contents of the selected storage medium or the directory.
For details related to setting the storing destination, see section 11.6.

Display of Compressed Images

12. When Image is selected under File Item, selecting a screen image data file (files with the .tif, .bmp, .ps, .png, or .jpg extensions) in the File List window and pressing **SELECT** causes the screen image file's compressed image to appear in the upper right portion of the file list.

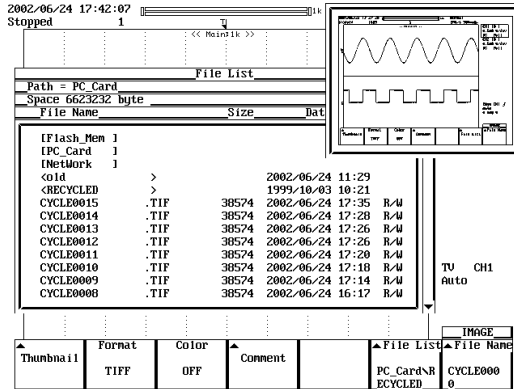

If compressed image (thumbnail) data does not exist for the selected file, an error message appears. Pressing **ESC** clears the error message.

Note

- The following procedure clears the compressed image from the screen.
- Move the cursor using the jog shuttle.

10.4 Storing Screen Image Data to the External Storage Medium

Selecting the File Name

13. Pressing the **File Name** soft key displays the file name setting menu.
14. Turn the jog shuttle to move the cursor to Auto Naming.

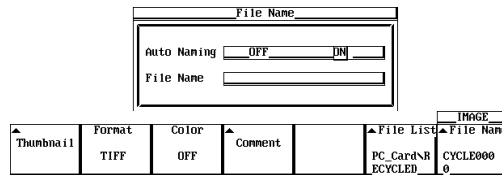

15. Press **SELECT** to select ON or OFF.
16. Turn the jog shuttle to move the cursor to File Name.
17. Pressing **SELECT** displays a keyboard. Enter the file name using up to sixteen characters according to the procedures given on section 4.1. If you turned ON the auto naming function, the first thirteen characters are valid.

Executing the Storing

18. Pressing **IMAGE SAVE** store the screen image.
Pressing **IMAGE SAVE** aborts the storing.

Displaying the Thumbnail Preview Window

19. Pressing the **Thumbnail** soft key causes a thumbnail of the screen image data located in the output directory specified in step 10 to be displayed (four thumbnails are displayed together). Pressing **ESC** closes the preview window.

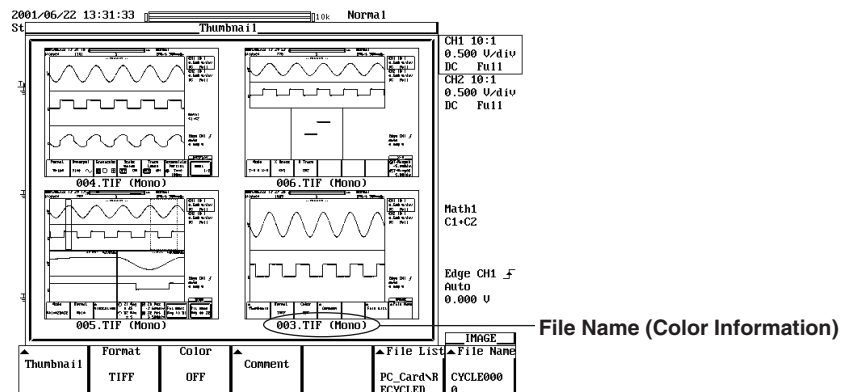

When no files supporting the thumbnail feature are present on the storage medium, an error message is displayed. Pressing **ESC** clears the error message.

Scrolling the Thumbnail Window

20. When five or more files supporting the thumbnail feature are present, you can scroll the window using the jog shuttle. To scroll the window upwards, turn the jog shuttle in the minus direction (counterclockwise). To scroll the window downwards, turn the jog shuttle in the plus direction (clockwise).

Note

Files supporting the thumbnail feature are scrolled two at a time.

Explanation

The screen image can be stored to storage medium (a floppy disk, a Zip disk, PC card, network drive (Ethernet interface option), or internal flash memory). For details, see Section 13.4, "Saving Screen Image Data to a Network Drive."

Storing Data Format

You can store the output data in the following formats. The file extensions and file sizes (reference value) that are automatically assigned are also listed.

Output Data Format	Extension	File Size*
TIFF	*.TIF	38,574 bytes (approx. 300 Kbytes)
BMP	*.BMP	38,462 bytes (approx. 300 Kbytes)
PostScript	*.PS	79,061 bytes
PNG	*.PNG	approx. 4 Kbytes (approx. 8 Kbytes)
JPEG	*.JPG	approx. 133 Kbytes (approx. 139 Kbytes)

*: When the color is OFF (reference value)

The file sizes in parentheses are the sizes when the color is ON.

Color (for TIFF, BMP, PNG, and JPG)

Select ON, ON(Revers), or OFF.

- ON : Outputs in 256 colors
- ON (Revers) : Background color is not output
- ON (GRAY) : Outputs in 16-shade grayscale
- OFF : Outputs in Black & White

Comments

You can add a comment string consisting of up to 20 characters on the screen and save the information.

Data Compression (for BMP Files)

BMP formats can be compressed in RLE formats, respectively, and output. However, if color is OFF, data in BMP format cannot be compressed.

- **Save Destination**

A list of available storage media is displayed in the File List dialog box.

Example

- Flash_Mem : Internal flash memory
- PC_Card : PC card
- FD : Floppy disk
- ZIP : Zip disk
- NetWork : Network drive (available with the Ethernet interface option)
- USB : USB storage

Floppy Disk, Zip Disk, and PC Card

The floppy disk, Zip disk, and PC card are described in chapter 11. For the procedures related to formatting, see chapter 11.

Auto Naming Function

If you use Auto Naming, files are automatically created with four digit numbers from 0000 to 2399 in their file name. You can place a common name in front of the numbers (up to 12 characters, specified in File Name).

Note

You can enter up to sixteen characters for the common name, but the last four characters are discarded.

10.4 Storing Screen Image Data to the External Storage Medium

Notes when Saving the File

- The maximum number of files that can be saved using the auto naming function is 2400.
- The maximum number of files and directories that can be displayed in the File List is 2400.

Also, a thumbnail window for screen image data can be displayed.

Thumbnail

• Thumbnail Window

The instrument can display a thumbnail window containing screen image files (with the .tif, .bmp, .ps, .png, and .jpg extensions) located in the directory selected from the File List under the IMAGE SAVE menu. The data used to generate the thumbnail is separate from the screen image data itself, but they are created at the same time. The extension of the thumbnail data depends on the extension of the original image data, and is shown as follows:

TIFF files : .ttd PNG files : .ntd
BMP files : .btd JPEG files : .jtd
PS files : .ptd

Each of these files is approx. 17 KB in size.

• Thumbnail Window Items

The following three items are displayed in the thumbnail window.

- A compressed image of the waveform
- File name
- Color information

The file name and color information appear on the bottom of the compressed waveform image.

• Thumbnail Display Window Format

Four thumbnails can be displayed in the window. The order in which the files are displayed is the same as that in the File List dialog box. Files are displayed from left to right and top to bottom.

• Scrolling the Thumbnail Window

If the number of files compatible with the thumbnail feature is greater than four, you can scroll the thumbnail window one row (2 thumbnails) at a time. To scroll the files upwards, turn the jog shuttle in the minus direction (counterclockwise). To scroll the files downwards, turn the jog shuttle in the plus direction (clockwise).

• Displaying Compressed Images in the File List

Selecting screen image data files from the File List causes a compressed image of the screen data to appear in the upper right portion of the File List. Also, file name and color information are not displayed in the compressed image.

11.1 Floppy Disks

Floppy Disks that can be Used

The following types of 3.5 inch floppy disk can be used. Floppy disks can be formatted on this instrument.

2HD: 1.44 MB (MS-DOS format)

2DD: 720 KB (MS-DOS format)

Inserting a Floppy Disk into the Drive

Hold the floppy disk with the label facing left, and insert it with the shutter section facing the drive. Insert the floppy disk until the eject button pops out.

Note

Floppy disks with bad sectors cannot be used unless you first repair them using a PC.

Removing the Floppy Disk from the Drive

Check that the access indicator is not lit, then press the eject button.

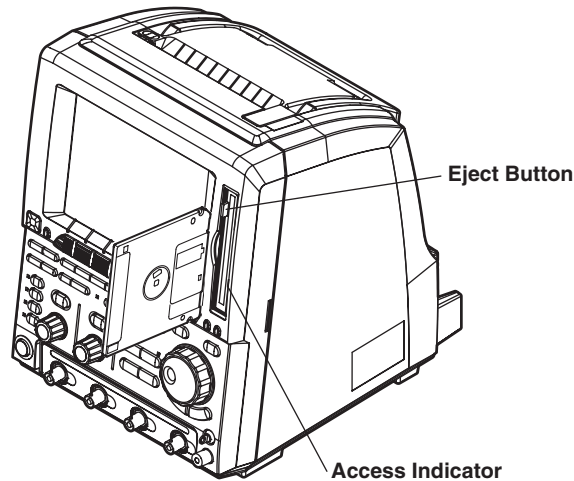

CAUTION

Do not remove the floppy disk or turn the instrument OFF when the access indicator is illuminated. Doing so can damage the storage medium or destroy the data on the medium.

General Handling Precautions

For general handling precautions, see the instructions that came with the floppy disk.

11.2 Zip Disks

Zip Disks that can be Used

The following types can be used. You can format the zip disk on the DL1620/DL1640/DL1640L.

Size: 100 MB and 250 MB

Format: FDISK 1 partition (hard disk format)

Inserting the Zip Disk in the Zip Drive

With the label facing left, insert the disk from the side with the shutter.

Removing the Zip Disk from the Zip Drive

With the DL1620/DL1640/DL1640L turned ON, check that the access indicator is turned OFF and press the eject button.

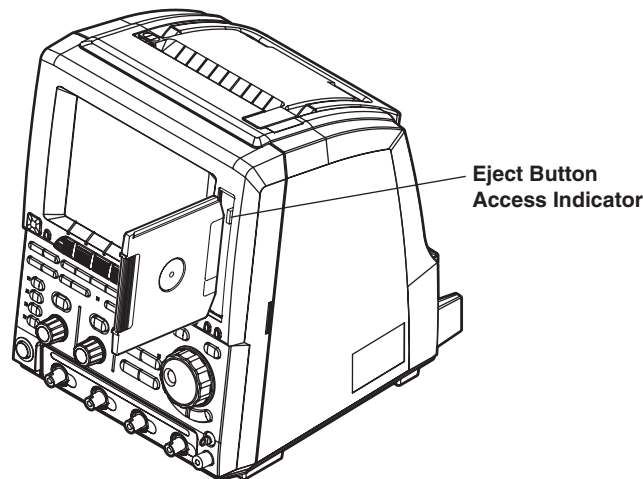

Procedure when the Zip Disk cannot be Ejected

If the Zip disk cannot be removed by performing the steps given above in "Removing the Zip Disk from the Zip Drive", carry out the following steps to remove it.

Insert a pin of approximately 1 mm in diameter into the eject button hole and press slowly. This will cause the Zip disk to be ejected.

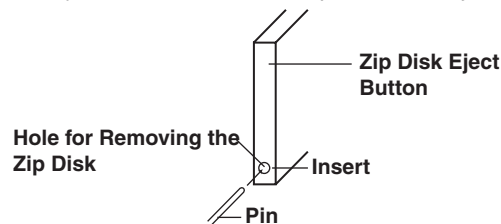

CAUTION

- Removing the Zip disk while the access indicator is ON may damage the data on the Zip disk.
- Do not use the Zip drive with the rear panel facing down. This may damage the data on the Zip disk.
- Do not turn the power ON or OFF when the Zip drive is installed, as this could damage the drive.
- When turning ON/OFF the DL1620/DL1640/DL1640L, have the Zip disk removed from the drive.
- Immediately after inserting the Zip disk, the access indicator lights. Do not use the instrument while the access indicator is lit as this may cause a malfunction.

Note

If you turn OFF the power when a Zip disk is inserted in the drive, the disk is ejected.

General Handling Precautions of Zip Disks

For the general handling precautions of the Zip drive, read the instruction manual that came with the Zip disk.

11.3 PC Card

PC Cards that can be Used

The instrument supports flash ATA cards (PC card TYPE II) and compact flash (using the PC card TYPE II adapter). In addition, some of the Flash ATA hard disk drive cards can be used. For details, contact the dealer from which you purchased the instrument.

Note

You must use a PC card-compatible computer when you want to use a PC card. The PC cards mentioned above may not work properly depending on the type of computer that you are using. Check the compatibility of your computer and PC card before working with a PC card.

Inserting the PC Card

Insert the PC card facing left into the PC card interface. The PC card interface is located on the back of the DL1620/DL1640/DL1640L.

Removing the PC Card

After confirming that the PC card is not being accessed, press the PC card eject button next to the PC card interface.

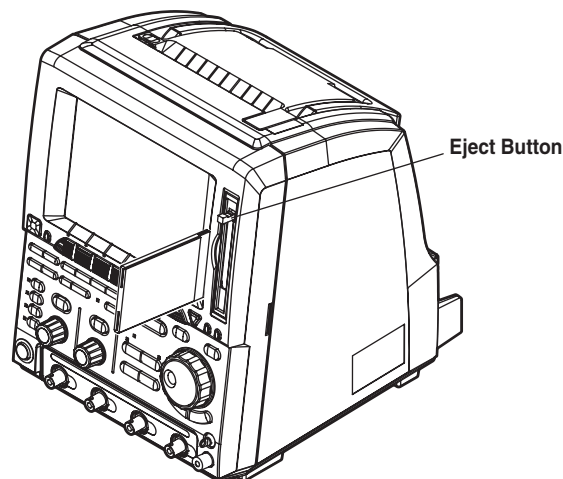

CAUTION

- The instrument may malfunction if the PC card is inserted and ejected within a one-second time period.
 - Do not remove the PC card or turn the power to the instrument OFF while the card is being accessed. Doing so can destroy the data on the medium.
 - While the PC card is being accessed, an “accessing” icon appears in the upper left part of the screen.
-

11.4 Connecting USB Storage to the USB PERIPHERAL Interface

Specifications of the USB PERIPHERAL Interface

Item	Description
Connector type	USB type A connector (receptacle)
Electrical and mechanical	USB Rev. 1.1
Data rate	12 Mbps max.
Power supply	5 V, 500 mA* (per port)
Number of ports	2

* Devices with maximum consumption currents exceeding 100 mA cannot be connected to two ports at the same time.

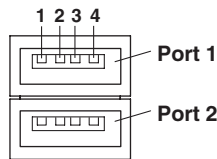

Pin No.	Signal Name
1	VBUS: +5 V
2	D- -Data
3	D+ +Data
4	GND: Ground

Connecting USB Storage

When connecting USB storage, directly connect the storage device to the instrument using a USB hub as shown below. You can connect the USB cable regardless of whether the power to the instrument is ON or OFF (supports hot-plugging). When the power switch is ON, the USB storage device is detected and enabled approximately six seconds after it is connected.

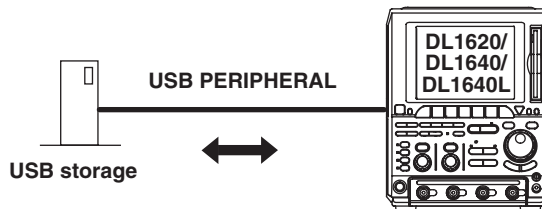

Compatible USB Storage

The instrument is compatible with USB mass storage class devices including hard disk drives, MO drives, and flash memory devices.

Note

- Do not connect USB devices other than a USB keyboard, USB mouse, USB printer, or USB storage device to the USB PERIPHERAL connector.
- The instrument has two USB PERIPHERAL connectors, but two USB devices with maximum consumption currents exceeding 100 mA cannot be connected at the same time.
- The instrument does not detect some of the flash memories. If the instrument does not detect the flash memory, it cannot be used. For details on compatible flash memories, contact your nearest YOKOGAWA dealer.

CAUTION

- Do not remove the USB storage device or turn the power to the instrument OFF while the device is being accessed. Doing so can destroy the data on the medium.
 - While the USB storage device is being accessed, an “accessing” icon appears in the upper left part of the screen.
-

General Handling Precautions of USB Storage

For the general handling precautions of the USB storage device, read the instruction manual that came with the device.

11.5 Formatting the Storage Medium



CAUTION

- Never remove the medium or turn OFF the power while the access indicator or storage medium icon is blinking. This can damage the medium or destroy the data on the medium.
- When the instrument cannot read a preformatted medium, reformat the medium. All data will be erased.

Relevant Keys

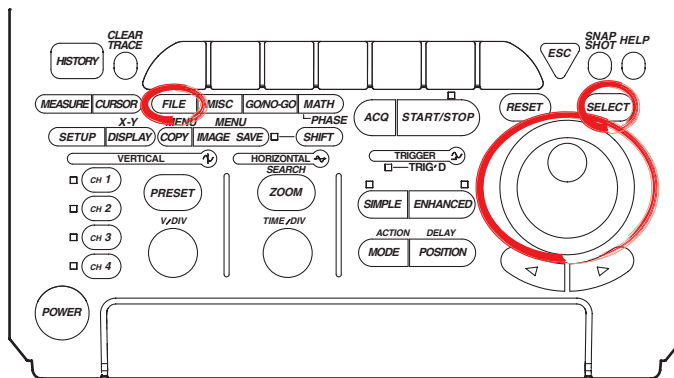

Operating Procedure

1. Press **FILE**.
2. Pressing the **Utility** soft key displays the utility setting menu and the file list dialog box.

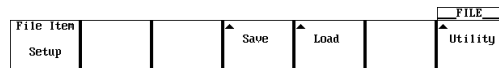

Selecting the Medium to be Formatted

3. Pressing the **Function** soft key displays the file function menu.

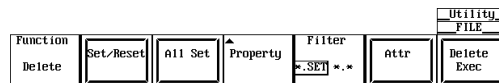

4. Pressing the **Format** soft key displays a list of media in the file list dialog box. (Net Drive cannot be formatted.)

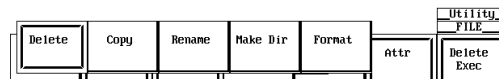

11.5 Formatting the Storage Medium

- Turn the jog shuttle to select the medium to be formatted.
If there are no external USB storage devices that are detected and only a floppy disk, Zip disk, or PC card is inserted, FD, ZIP, or PC_Card is displayed along with Flash_Mem.

File List		
File Name	Size	Space
Flash_Mem	2097152	599920
PC_Card	10407936	6578176

Function	Media Info	Format				Utility FILE
Format						

Selecting the FD Format

- Pressing the **Format** soft key displays the format menu.

Function	Media Info	Format				Utility FILE
Format						

- Turn the jog shuttle to select the format 2DD 720 K or 2HD 1.44 M. Go to step 8.

Function	Media Info	FD Format				Format Utility FILE Exec
Format		2HD 1.44M				

Selecting the Format Type for the Zip Disk

- Pressing the **Format** soft key displays the format menu.

Function	Media Info	Format				Utility FILE
Format						

- Press the **Format Type** soft key to select Norm or Quick. Go to step 8.

Function	Media Info	Format	Format Type			Format Utility FILE Exec
Format			Norm Quick			

• Setting the PC Card and USB Storage Partitions

- Press the **Format** soft key to display a menu used to set the PC card partitions.

Function	Media Info	Format				Utility FILE
Format						

- Turn the jog dial to set the number of partitions. Go to step 8.

Function	Media Info	Partition Format Type				Format Utility FILE Exec
Format		2	Norm Quick			

Note

Storage medium that is already partitioned can be selected and formatted as separate storage media, but the separate storage media cannot be partitioned further.

- **Formatting the Internal Flash Memory**
6. Press the **Format** soft key to display the format menu. Proceed to step 8.

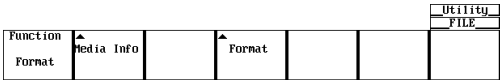

- **Executing/Canceling the Format Operation (OK/Cancel)**

8. Pressing the **Exec** soft key displays the alert dialog box.

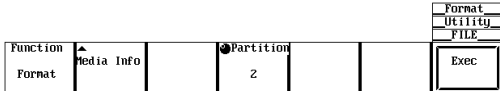

9. Turn the jog shuttle to select OK or Cancel.
10. Selecting OK and pressing **SELECT** starts the format operation. Selecting Cancel and pressing **SELECT** cancels the format operation.

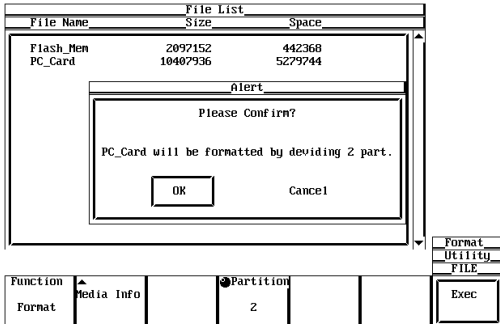

Viewing the Media Information

Follow steps 1-5 to select a media.

6. Pressing the **Media Info** soft key displays information about the medium that was selected in step 5.

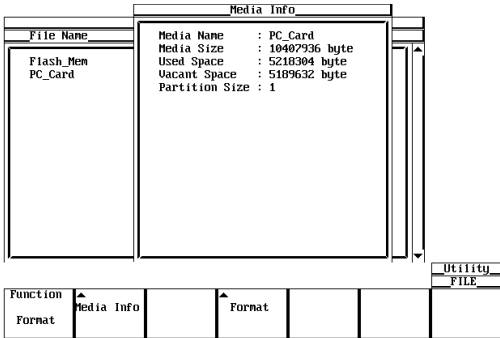

Explanation

Formatting a Floppy Disk

When using a new floppy disk, you must format it first. Select the appropriate format for the floppy disk from the following choices.

The DL1620/DL1640/DL1640L performs physical formatting.

2DD 720 K

Formats the 2DD floppy disk to 720 KB/9 sectors.

2HD 1.44 M

Formats the 2HD floppy disk to 1.44 MB/18 sectors.

11.5 Formatting the Storage Medium

Formatting a Zip Disk

If you are using a new Zip disk, you need to format it. The format for 250 MB and 100 MB disks is as follows:

FDISK 1 partition (hard disk format)

The DL1620/DL1640/DL1640L performs logical formatting.

Formatting a PC Card

Flash ATA cards and compact flash using the PC card TYPE II adapter are formatted to IBM-compatible format.

Formatting a USB Storage

USB storage are initialized in FAT format.

Number of Partitions

You can set partitions on PC cards and USB storage devices. However, partitions cannot be specified on USB storage devices handled as removable disks. In addition, a storage medium that is already partitioned can be selected and formatted as a separate storage medium, but the separate storage medium cannot be partitioned further. On PC cards and USB storage devices, you can select 1 to 4 partitions.

Information about the Medium

The following information is listed for the selected medium.

Media Name: Name of the medium

Media Size: Total capacity

Used Space: Used space

Vacant Space: Free space

Partition Size: Number of partitions

Vendor Name: Maker name (only on USB storage devices)

Product Name: Product name (only on USB storage devices)

Note

- Formatting a medium containing data erases the data completely.
 - The time it takes to format a floppy disk is approximately two minutes.
 - The time needed to format a 250-MB Zip disk is approximately 4 s.
 - It takes a few seconds to format a PC card.
 - A floppy disk cannot be formatted if it is write protected.
 - Floppy disks having a format other than the ones listed in this section cannot be used.
 - If an error message appears after the format operation, the floppy disk may be damaged.
 - Disks formatted to MS-DOS format on a PC can also be used.
 - This function can not be used in conjunction with the FTP server, FTP client, LPR client, or Web server functions.
-

11.6 Saving/Loading Waveform Data



CAUTION

Never remove the medium or turn OFF the power while the access indicator or storage medium icon is blinking. This can damage the medium or destroy the data on the medium.

Relevant Keys

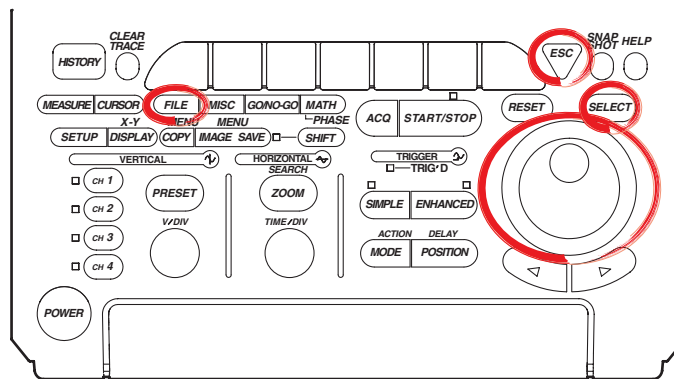

Operating Procedure

1. Press **FILE**.
2. Pressing the **File Item** soft key displays the file time setting menu.

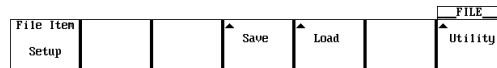

3. Press the soft key corresponding to **Waveform**.

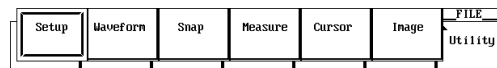

Saving the Waveform Data

Selecting the Data Type

4. Pressing the **Data Type** soft key displays the data type menu.

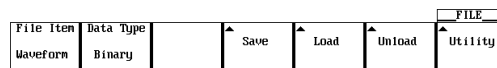

5. Press the one of the soft keys corresponding to **Binary**, **ASCII**, or **Float** to select the data type.

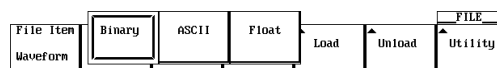

Data saved in Binary are only the data that can be loaded as described later in this chapter.

11.6 Saving/Loading Waveform Data

Selecting the Waveform to be Saved.

6. Pressing the **Save** soft key displays the save setting menu.

File Item	Data Type		Save	Load	Unload	FILE
Waveform	Binary					Utility

7. Pressing the **Trace** soft key displays the waveform menu.

File List	File Name	Trace	Range		Length	Save
PC_Card	0000	All	Main		Auto	FILE
						Save Exec (Binary)

8. Press the soft key corresponding to the channel you wish to save. (CH3, CH4, and Math2 are not displayed on the DL1620.)

	All	CH1	CH2	CH3	CH4	Math1	Math2	Save

Selecting the Range of the Waveform to be Saved

9. Pressing the **Range** soft key displays the save range selection menu.
10. Press one of the **Main to Z1 & Z2** soft keys to select the range of waveforms to be saved.

File List	File Name	Trace	Main	Z1	Z2	Z1&Z2	Save
PC_Card	0000	All					

Selecting the Compression Format

11. Press the **Compression** soft key to select PP or Decim.

Selecting Compressed Data Length

12. Turn the jog dial to select the length of the compressed data. If you select Auto, the entire display record length is saved.

Selecting the Destination Medium/Directory

13. Pressing the **File List** soft key displays the file list dialog box.
14. Turn the jog shuttle to select the save destination medium (displayed with parentheses).

File List			
Path = PC_Card			
Space 5312512 byte			
File Name	Size	Date	Attr
(Flash_Mem)			
(PC_Card)			
(NetWork)			
< Restore	>	2002/07/02 10:19	
<old	>	2002/06/24 11:29	
<RECYCLED	>	1999/10/03 10:21	
0001	.TTD 1489	2002/07/12 18:34	R/W
0001	.TIF 38574	2002/07/12 18:34	R/W
0000	.TTD 1590	2002/07/12 18:31	R/W
0000	.TIF 38574	2002/07/12 18:31	R/W
CYCLE0006	.TTD 2336	2002/07/12 13:27	R/W
CYCLE0006	.TIF 38574	2002/07/12 13:27	R/W
CYCLE0005	.TTD 2348	2002/07/12 13:24	R/W

File List	File Name	Property	Filter	Save
PC_Card	0000		*.WVF [F..]	FILE
				Save Exec (Binary)

15. Press **SELECT** to confirm the selection.

Selecting the Destination Directory

(Use this only when there are directories on the medium.)

16. Turn the jog shuttle to select the save destination directory (displayed in angle brackets < >).
17. Press **SELECT** to confirm the selection.
The Path=___ box on the top left corner of the File List dialog box displays the selected medium/directory.
Selecting <..> moves to a higher level directory.

Setting the File Name/Comment

18. Pressing the **File Name** soft key displays the file name setting menu.
19. Turn the jog shuttle to select Auto Naming.

File List	File Name	Trace	Range	Length	Save FILE
PC_Card	0000	All	Main	Auto	Save Exec (Binary)

20. Press **SELECT** to select ON or OFF.
21. Turn the jog shuttle to select File Name.
22. Pressing **SELECT** displays a keyboard.
23. Enter the file name according to the procedures given in section 4.1.
24. Turn the jog shuttle to select Comment.
25. Pressing **SELECT** displays a keyboard.
26. Enter the file comment according to the procedures given in section 4.1.
27. Press **ESC** to close the file name setting dialog box.

Note

When Data Type is Float, Comment is not available.

Saving the File

28. Press the **Save Exec** soft key to save the file to the directory indicated in Path=___ . The name of the **Save Exec** soft key changes to **Abort**.

Canceling the Saving Operation

29. Press the **Abort** soft key to cancel the save operation. The name of the **Abort** soft key changes to **Save Exec**.

Specifying the File to be Displayed in the File List Dialog Box and Viewing its Properties

30. In the File List dialog box, press the **Filter** soft key to select *.extension or *.*.
31. In the File List dialog box, turn the jog shuttle to select the desired file.
32. Pressing the **Property** soft key displays the properties of the selected file.
33. Pressing **ESC** closes the window displaying the properties.

Loading the Waveform Data

Set the data type to Binary. For the procedures, see steps 4 and 5 in the section “Saving the Waveform Data”.

- Pressing the **Load** soft key displays the load setting menu and the file list dialog box.

File Item	Data Type		Save	Load	Unload	FILE
Waveform	Binary					Utility

Selecting the Source Medium/Directory

- Select the directory according to steps 13 to 17.

Selecting the File to be Loaded

- Turn the jog shuttle to select a file.

Loading Setup Data with the File

- Press the **With Step** soft key to select ON (load setup data) or OFF (do not load setup data).

			Property	Filter	With Setup	FILE
				*.WVF	OFF	Load Exec (Binary)

Loading the File

- Press the **Load Exec** soft key to load the file from the directory indicated in Path=____. The name of the **Load Exec** soft key changes to **Abort**.

Canceling the Loading Operation

- Press the **Abort** soft key to cancel the loading operation. The name of the **Abort** soft key changes to **Load Exec**.

Specifying the File to be Displayed in the File List Dialog Box, Viewing the Properties

The procedures are the same as steps 30 and 31 when saving files.

Unloading Waveforms

Selecting the File to be Unloaded

- Continuing from step 5 in “Saving the waveform data,” press the **Unload** soft key to display the Unload menu.

File Item	Data Type		Save	Load	Unload	FILE
Waveform	Binary					Utility

- Pressing the **Trace** soft key displays a menu used to select the channels to be unloaded.

		Trace				FILE
		All				Unload Exec (Binary)

- Press the soft key corresponding to the desired channel to select the channel. If All is selected, all channels are unloaded. (CH3, CH4, and Math2 are not displayed on the DL1620.)

						FILE
		All	CH1	CH2	CH3	CH4

Unloading the File

- Press the **Unload Exec** soft key.

Explanation**Selecting the Data Type, File Extension****Binary**

- The sampled data in the acquisition memory are saved in binary format.
- The data that are saved can be loaded to display the waveform and compute numerical data.
- A header file is automatically created. The header file is used when analyzing the waveform on a PC. The header file cannot be opened using this instrument. For the header file format, see Appendix 3, "ASCII Header File Format."
- The file extension is .WVF. The file extension of the header file is .HDR.
- When saving waveform data in binary format, a header file is automatically created with the extension .HDR. When the DL1620/DL1640/DL1640L is used to copy, delete, change filenames, or change file ownership of waveform data files (files with the extension, .WVF), the header files are automatically updated to reflect the changes. Do not delete the header file only or the waveform data file only as this may cause a system malfunction.

ASCII

- The units of the sampled data in the acquisition memory are converted per the specified range and saved in ASCII format. The data can be used to analyze the waveform on a PC.
- Data in this format cannot be loaded on this instrument.
- The file extension is .CSV.

Float

- The units of the sampled data in the acquisition memory are converted per the specified range and saved in 32-bit floating format. The data can be used to analyze the waveform on a PC.
- The order of the data is little-endian (Intel format).
- Data in this format cannot be loaded on this instrument.
- The file extension is .FLD.

Data Size

The following list shows the data size when the record length is set to 100 kwords, waveform data of CH1 to CH4 are saved, and Math1 and Math2 are turned OFF

Data Type	Extension	Data Size (Bytes)
Binary	.WVF	Approx. 850 K bytes $((100 \text{ kwords} + 32) \times 4 \text{ channels} \times \text{number of history waveform} \times 2 + 46 \text{ K})$
	.HDR	Approx. 2 K bytes (approx. 3 K if Math1 and Math2 are ON.)
ASCII	.CSV	Approx. 4 M to 5 M bytes (depends on the input signal condition.) It takes more than 10 minutes to save the file.
Float	.FLD	Approx. 1.6 Mbytes $((100 \text{ kwords} + 32) \times 4 \text{ channels} \times \text{number of history waveform} \times 4)$

Selecting the Waveform to be Saved

- You can save all waveforms or the specified waveforms from CH1 to CH4, Math1, Math2 (or CH1, CH2, and Math1 for the DL1620).
- The vertical and horizontal axes and trigger settings of the waveform being saved are also saved.
- For waveforms that are loaded using the history memory function, you can save only the waveform currently displayed. You can also save only the search results of the data in the history memory.
For details regarding data search of the history memory, see sections 7.8 to 7.9.
- For snapshot waveforms, see section 11.8, "Saving/Loading the Snapshot Waveforms."

Selecting the Range of the Waveform to be Saved

Select the range (region) of the waveform from the following list of choices. Only the data that have been saved by selecting Binary above in “Selecting the data type, file extension, data size” can be loaded in this instrument.

- Main
The range of the normal (Main) waveform. It is the range defined by the displayed record length (range displayed on the screen).
- Z1
The range of zoom waveform Z1.
- Z2
The range of zoom waveform Z2.
- Z1 & Z2
The range of zoom waveform Z1 & Z2.

Selecting the Compression Format

- You can select whether to P-P compress or Decim compress the waveform data before saving it.
- Power spectrum computation data cannot use P-P compression.

Selecting the Medium and Directory

The storage medium that can be used to save and load waveform data are displayed in the File List dialog box.

Display Example of Storage Medium

Flash_Mem : Internal flash memory
PC_Card : PC card
FD : Floppy disk
ZIP : Zip disk
NetWork : Network drive (available with the Ethernet interface option)
USB : USB storage

File Name and Comments

- You must specify a file name. Comments can be omitted.
- You cannot save to a file name that is already in use in the same directory (no overwriting).

Number and Types of Characters that can be Used

Item	Number of Characters	Characters that Can be Used
File name	1 to 16 chars.	0 to 9, A to Z, %, _, () (parenthesis), -(minus sign)
Comment	0 to 25 chars.	All characters (including spaces),

Auto Naming Function

When Auto Naming is turned ON, files with four digit numbers from 0000 to 2399 are automatically created. Specify the common name (maximum of twelve characters, specify at the Filename item) that is placed before the four digit number.

Specifying the Files to Display in the File list Dialog Box

You can specify the type of files to display.

- *.WVF, *.CSV, or *.FLD
Displays only the files that have the same file format as the file being saved.
- *.*
Displays all files on the medium.

Properties

Lists the file name.extension, file size, the date it was saved, the attributes, and the comment for the selected file.

Unload

If the loaded waveform is being displayed, newly acquired waveform is not displayed even if the data acquisition is started. In order to display the newly acquired waveforms, loaded data must be unloaded from the appropriate channels.

Note

- If a key other than the Abort key is pressed during saving or loading, an error occurs.
- You cannot save or load while the data acquisition is in progress.
- If you change the file extension on a PC, for an example, you will not be able to load that file.
- A maximum of 43 characters can be displayed in Path. If the character string exceeds 43 characters, “...” is appended at the end.
- File names are not case sensitive. Comments are case sensitive. In addition, the following file names cannot be used due to limitations of MS-DOS.
AUX, CON, PRN, NUL, CLOCK, COM1 to COM9, LPT1 to LPT9
- The waveform data loaded from a file overwrites the data in the acquisition memory. Once the memory is overwritten, the old data cannot be recovered. It is recommended that the current waveform data be saved before loading data from a file.
- Loaded waveforms are cleared only if Unload, Initialize, or Auto Setup is executed or the data acquisition conditions are changed.
- The maximum number of files and directories that can be displayed in the File List is 2400.
- This function can not be used in conjunction with the FTP server, FTP client, LPR client, or Web server functions.
- Waveform (.wvf) and header (.hdr) files are saved as file pairs. If you set the filter of the files displayed in the file list to *.* then process (Delete, Rename, Copy) each file individually, the files become unloadable.
- When loading waveform data of the maximum record length, automatic measurement of waveform parameters and statistical processing cannot be performed on calculated waveforms. ***** is displayed for the measured results.
- Files without the archive attribute are not displayed in the File List dialog box.

Data Format when Storing Multiple Records

When multiple records are stored (history memory, for example), the following data format is used.

ASCII Format: CR+LF is inserted between records.

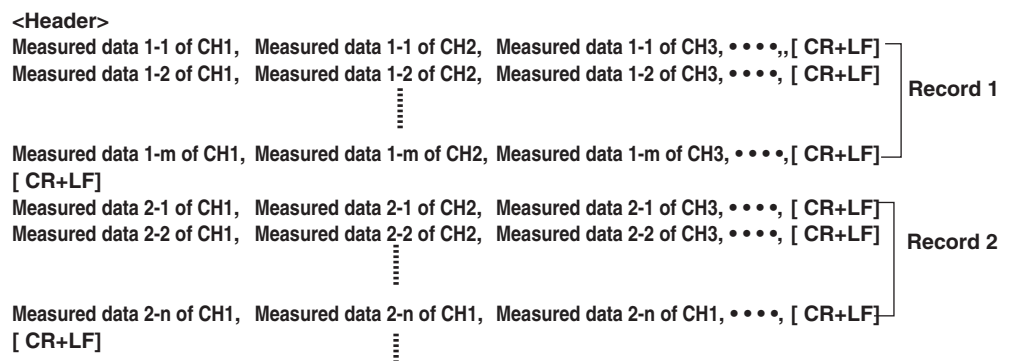

Float Format: Stored in blocks of channels.

Measured data of record 1 of CH1
Measured data of record 2 of CH1
⋮
Measured data of record N of CH1
Measured data of record 1 of CH2
Measured data of record 2 of CH2
⋮
Measured data of record N of CH2
⋮

11.7 Saving/Loading Setup Data



CAUTION

Never remove the medium or turn OFF the power while the access indicator or storage medium icon is blinking. This can damage the medium or destroy the data on the medium.

Relevant Keys

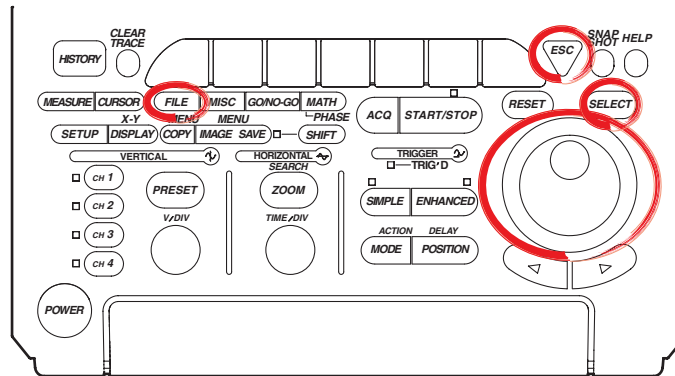

Operating Procedure

1. Press **FILE**.
2. Pressing the **File Item** soft key displays the file item setting menu.

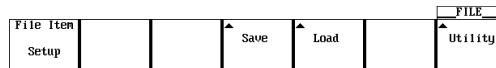

3. Press the **Setup** soft key.

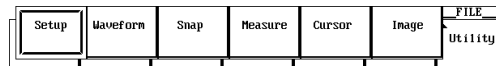

Selecting the Setup Data

Selecting the Destination Medium

4. Pressing the **Save** soft key displays the save setting menu.

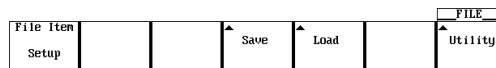

5. Pressing the **File List** soft key displays the file list dialog box.



- Turn the jog shuttle to select the save destination medium (displayed with parentheses).

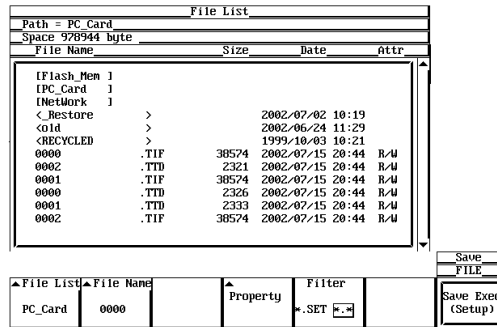

- Press **SELECT** to confirm the selection.

Selecting the Destination Directory

(Use this only when there are directories on the medium.)

- Turn the jog shuttle to select the save destination directory (displayed in angle brackets < >).
- Press **SELECT** to confirm the selection.
The Path=___ box on the top left corner of the File List dialog box displays the selected medium/directory.
Selecting <..> moves to a higher level directory.

Setting the File Name/Comment

- Pressing the **File Name** soft key displays the file name setting menu.

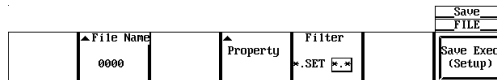

- Turn the jog shuttle to select Auto Naming.

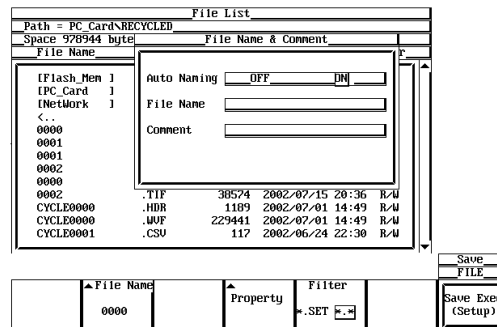

- Press **SELECT** to select ON or OFF.
- Turn the jog shuttle to select File Name.
- Pressing **SELECT** displays a keyboard.
- Enter the file name according to the procedures given in section 4.1.
- Turn the jog shuttle to select Comment.
- Pressing **SELECT** displays a keyboard.
- Enter the file comment according to the procedures given in section 4.1.
- Press **ESC** to close the file name setting dialog box.

11.7 Saving/Loading Setup Data

Saving the File

20. Press the **Save Exec** soft key to save the file to the directory indicated in Path=____. The name of the **Save Exec** soft key changes to **Abort**.

Canceling the Saving Operation

21. Press the **Abort** soft key to cancel the save operation. The name of the **Abort** soft key changes to **Save Exec**.

Specifying the File to be Displayed in the File List Dialog Box, and Viewing its Properties

22. In the File List dialog box, press the **Filter** soft key to select *.SET or *.*.
23. In the File List dialog box, turn the jog shuttle to select the desired file.
24. Pressing the **Property** soft key displays information regarding the selected file.
25. Pressing **ESC** closes the window displaying the information.

Loading the Setup Data

Display the menu used to save/load setup data according to steps 1 to 3.

4. Pressing the **Load** soft key displays the load setting menu and the file list dialog box.

File Item			Save	Load	FILE
Setup					Utility

Selecting the Source Medium/Directory

5. Select the directory according to steps 13 to 17 on section 11.6.

Selecting the File to be Loaded

6. Turn the jog shuttle to select a file.

Loading the File

7. Press the **Load Exec** soft key to load the file from the directory indicated in Path=____. The name of the **Load Exec** soft key changes to **Abort**.

Canceling the Loading Operation

8. Press the **Abort** soft key to cancel the loading operation. The name of the **Abort** soft key changes to **Load Exec**.

Specifying the File to be Displayed in the File List Dialog Box, Viewing the Properties

The procedures are the same as steps 22 to 25.

Explanation

Setup Data that are Saved

The setup data of each key existing at the time of the saving operation are saved. However, date and time, and communication parameters are not saved.

Number of Bytes Necessary in Saving the Setup Data

Approximately 28 Kbytes

Selecting the Medium and Directory

The storage medium that can be used to save and load waveform data are displayed in the File List dialog box.

- **Display Example of Storage Medium**

Flash_Mem : Internal flash memory
 PC_Card : PC card
 FD : Floppy disk
 ZIP : Zip disk
 NetWork : Network drive (available with the Ethernet interface option)
 USB : USB storage

- **File Name and Comments**

You must specify a file name. Comments can be omitted.
 You cannot save to a file name that is already in use in the same directory (no overwriting).

- **Number and Types of Characters that can be Used**

Item	Number of Characters	Characters that can be Used
File name	1 to 16 chars.	0 to 9, A to Z, %, _, () (parenthesis), - (minus sign)
Comment	0 to 25 chars.	All characters (including spaces),

- **Notes when Saving Setup Data**

You cannot save while the data acquisition is in progress. Press **START/STOP** to stop the acquisition.
 The maximum number of files and directories that can be displayed in the File List is 2400.

- **File Extension**

The File extension .SET is automatically appended to the file.

- **Auto Naming Function**

When Auto Naming is turned ON, files with four digit numbers from 0000 to 2399 are automatically created. Specify the common name (maximum of twelve characters, specify at the Filename item) that is placed before the four digit number.

- **Specifying the Files to Display in the File List Dialog Box**

You can specify the type of files to display.

- *.SET
Displays only the setup data files.
- *.*
Displays all files on the medium.

- **Properties**

Lists the file name.extension, file size, the date it was saved, the attributes, and the comment for the selected file.

Note

- If a key other than the Abort key is pressed during saving or loading, an error occurs.
 - You cannot save or load while the data acquisition is in progress.
 - If you change the file extension on a PC, for an example, you will not be able to load that file.
 - A maximum of 43 characters can be displayed in Path. If the character string exceeds 43 characters, “...” is appended at the end.
 - File names are not case sensitive. Comments are case sensitive. In addition, the following file names cannot be used due to limitations of MS-DOS.
AUX, CON, PRN, NUL, CLOCK, COM1 to COM9, LPT1 to LPT9
 - When the setup parameters are loaded from a file, the setup parameters of each key are overwritten with the loaded settings and cannot be set back to their previous settings. It is recommended that the current setup parameters be saved before loading setup parameters from a file.
 - The date and time, and communication parameters are not saved. Therefore, when setup parameters are loaded from a file, these parameters do not change.
 - This function can not be used in conjunction with the FTP server, FTP client, LPR client, or Web server functions.
 - Files without the archive attribute are not displayed in the File List dialog box.
-

11.8 Saving/Loading Snapshot Waveforms



CAUTION

Never remove the medium or turn OFF the power while the access indicator or storage medium icon is blinking. This can damage the medium or destroy the data on the medium.

Relevant Keys

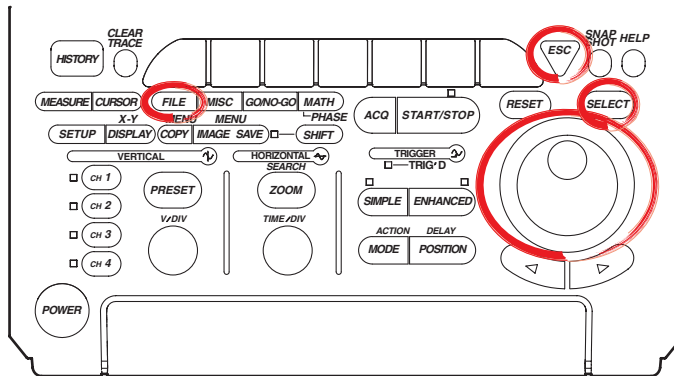

Operating Procedure

1. Press **FILE**.
2. Pressing the **File Item** soft key displays the file item setting menu.

File Item					FILE
Setup		Save	Load		Utility

3. Press the **Snap** soft key.

Setup	Waveform	Snap	Measure	Cursor	Inage	FILE
						Utility

Saving Snapshot Waveforms

Selecting the Destination Medium/Directory

The procedures are the same as steps 13 to 17 in section 11.6, "Saving/Loading Waveform Data."

Setting the File name/Comment

The procedures are the same as steps 18 to 27 in section 11.6, "Saving/Loading Waveform Data."

Note

When you save a snapshot waveform, Comment is not available.

11.8 Saving/Loading Snapshot Waveforms

Saving the File

- Press the **Save Exec** soft key to save the file to the directory indicated in Path=____. The name of the **Save Exec** soft key changes to **Abort**.

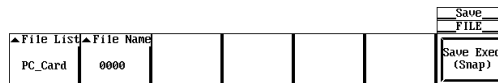

Canceling the Saving Operation

- Press the **Abort** soft key to cancel the saving operation. The name of the **Abort** soft key changes to **Save Exec**.

Specifying the File to be Displayed in the File List Dialog Box, Viewing the Properties

The procedures are the same as steps 30 to 33 in section 11.6, "Saving/Loading Waveform Data."

Loading Snapshot Waveforms

Follow steps 1-3 to select snapshot data waveforms.

- Pressing the **Load** soft key displays the load setting menu and the file list dialog box.

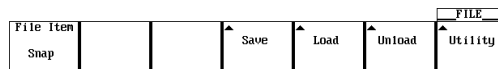

Selecting the Source Medium/Directory

The procedures are the same as steps 13 to 17 in section 11.6, "Saving/Loading Waveform Data."

Selecting the File to be Loaded

- Turn the jog shuttle to select a file.

Selecting the Snapshot Waveform to be Loaded

- Press the **Destination** soft key to display a menu used to select the snapshot waveform.

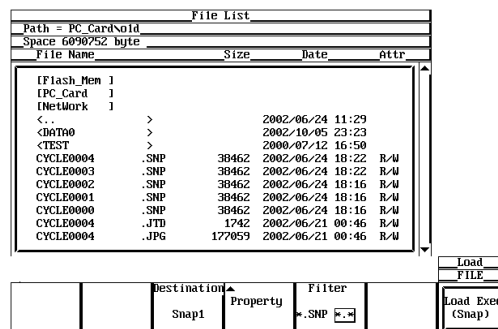

- Press the soft key corresponding to the desired snapshot waveform to make the selection.

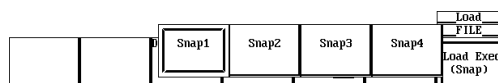

Loading the File

- Press the **Load Exec** soft key to load the file from the directory indicated in Path= ____. The name of the **Load Exec** soft key changes to **Abort**.

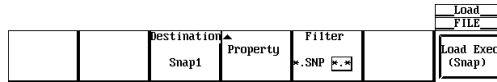

Canceling the Loading Operation

- Press the **Abort** soft key to cancel the loading operation. The name of the **Abort** soft key changes to **Load Exec**.

Specifying the File to be Displayed in the File List Dialog Box, Viewing the Properties

The procedures are the same as steps 30 to 33 in section 11.6, "Saving/Loading Waveform Data."

Clearing the Waveform

Follow steps 1-3 to select snapshot data waveforms.

- Pressing the **Unload** soft key displays a menu used to select the waveform to be cleared.

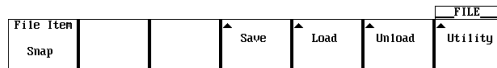

- Press the **Trace** soft key and press the soft key corresponding to the waveform to be cleared.

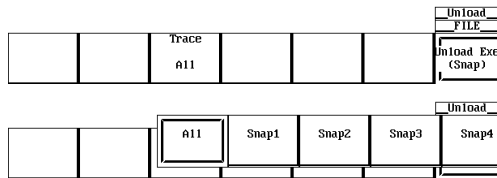

- Pressing the **Unload Exec** soft key clears the selected waveform.



Explanation

You can take snap shots of the waveform and save the image to the file. You can also load the snapshot waveform.

Data Size

Approx. 40 Kbytes

File Extension

The file extension is .SNP.

The selection of the medium and directory, file name, comments, auto naming function, specification of the files to be displayed in the File List dialog box, and properties are the same as those for saving/loading normal waveform data. For explanation and procedures, see section 11.6, "Saving/Loading Waveform Data."

Loading the Snapshot Waveform

The snapshot waveform can be load as four waveforms, Snap1 to Snap4.

Clearing the Waveform

The loaded snapshot waveform is cleared when unload, initialize, or auto setup is performed.

Note

- If a key other than the Abort key is pressed during saving or loading, an error occurs.
 - This function can not be used in conjunction with the FTP server, FTP client, LPR client, or Web server functions.
-

11.9 Saving the Results of the Automated Measurement of Waveform Parameters



CAUTION

Never remove the medium or turn OFF the power while the access indicator or storage medium icon is blinking. This can damage the medium or destroy the data on the medium.

Relevant Keys

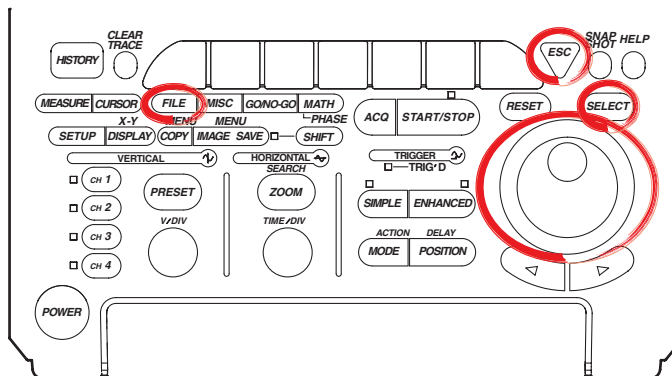

Operating Procedure

1. Press **FILE**.
2. Pressing the **File Item** soft key displays the file item setting menu.

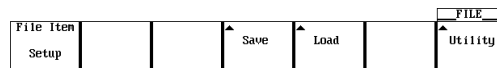

3. Press the soft key corresponding to **Measure**.

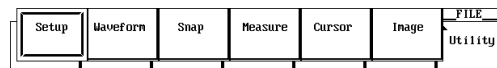

Selecting the Destination Medium/Directory

The procedures are the same as steps 13 to 17 in section 11.6, "Saving/Loading Waveform Data."

Setting the File Name/Comment

The procedures are the same as steps 18 to 27 in section 11.6, "Saving/Loading Waveform Data."

Note

When saving the results of the automated measurement of waveform parameters, Comment is not available.

11.9 Saving the Results of the Automated Measurement of Waveform Parameters

Saving the File

- Press the **Save Exec** soft key to save the file to the directory indicated in Path=____. The name of the **Save Exec** soft key changes to Abort.

File List	File Name					Save FILE
PC_Card	0000					Save Exec (Measure)

Canceling the Saving Operation

- Press the **Abort** soft key to cancel the saving operation. The name of the **Abort** soft key changes to Save Exec.

Specifying the File to be Displayed in the File List Dialog Box, Viewing the Properties

The procedures are the same as steps 30 to 33 in section 11.6, "Saving/Loading Waveform Data."

Explanation

The results of the automated measurement of waveform parameters can be saved in CSV format (.CSV file extension) to a floppy disk, a Zip disk, PC card or USB storage. A CSV file is a comma-separated format file. The CSV file is one of the common file formats used to exchange data between spreadsheet and database applications. The data that are saved are the measurement results of the parameters that are specified in the automated measurement of waveform parameters.

Notes when Saving the Results of the Automated Measurement of Waveform Parameters

The restrictions are as follows.

- Up to (32000/the number of items that are turned ON) data points before the point at which the save operation is executed are saved. However, the data points that are saved are limited to those that are acquired after fixing T/div, V/div, and Measure settings.

- Output example

	CH1 P-P, V,	CH1 Max, V,	CH1 Min, V,	CH2 P-P V	
-70	0.199E+00,	0.199E+00,	0.000E+00,	0.02E-06	Oldest data
-65	0.207E+00,	0.207E+00,	0.000E+00,	0.02E-06	
-60	0.377E+00,	0.152E+00,	-0.125E+00,	0.02E-06	
•	•	•	•	•	↓
•	•	•	•	•	
•	•	•	•	•	
•	•	•	•	•	Newest data

For information related to the automated measurement of waveform parameters, see section 9.2, "Automated Measurement of Waveform Parameters."

Data Size

Data size = Number of items × 15 × number of history waveforms

11.9 Saving the Results of the Automated Measurement of Waveform Parameters

File Extension

The file extension is .CSV.

The selection of the medium and directory, file name, comments, auto naming function, specification of the files to be displayed in the File List dialog box, and properties are the same as those for saving/loading normal waveform data. For explanation and procedures, see section 11.5, "Saving/Loading Waveform Data."

Note

- If a key other than the **Abort** key is pressed during saving, an error occurs.
 - This function can not be used in conjunction with the FTP server, FTP client, LPR client, or Web server functions.
-

11.10 Saving the Cursor Measurement Values



CAUTION

Never remove the medium or turn OFF the power while the access indicator or storage medium icon is blinking. This can damage the medium or destroy the data on the medium.

Relevant Keys

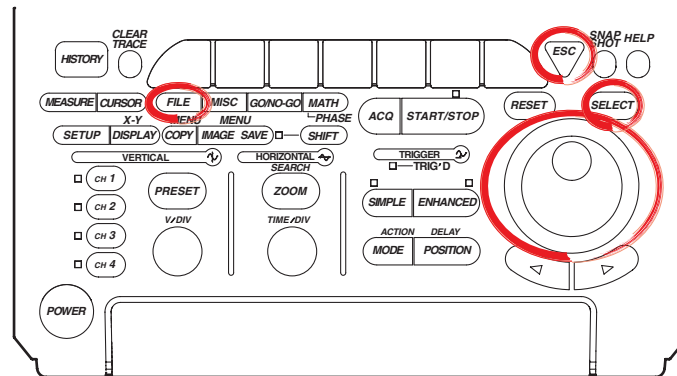

Operating Procedure

1. Press **FILE**.
2. Pressing the **File Item** soft key displays the file item setting menu.

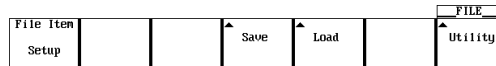

3. Press the soft key corresponding to **Cursor**.

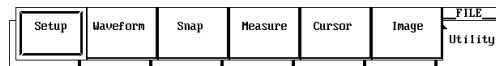

Selecting the Destination Medium/Directory

The procedures are the same as steps 13 to 17 in section 11.6, "Saving/Loading Waveform Data."

Setting the File Name/Comment

The procedures are the same as steps 18 to 27 in section 11.6, "Saving/Loading Waveform Data."

Note

When saving the results of the cursor measurement values, Comment is not available.

Saving the File

- Press the **Save Exec** soft key to save the file to the directory indicated in Path= ____. The name of the **Save Exec** soft key changes to Abort.

File List	File Name					Save FILE
PC_Card	0000					Save Exec (Cursor)

Canceling the Saving Operation

- Press the **Abort** soft key to cancel the saving operation. The name of the **Abort** soft key changes to Save Exec.

Specifying the File to be Displayed in the File List Dialog Box, Viewing the Properties

The procedures are the same as steps 30 to 33 in section 11.6, "Saving/Loading Waveform Data."

Explanation

The cursor measurement values can be saved in CSV format (.CSV file extension) to a floppy disk, a Zip disk, PC card, or USB storage.

A CSV file is a comma-separated format file. The CSV file is one of the common file formats used to exchange data between spreadsheet and database applications.

The data that are saved are the cursor measurement values.

This function is valid for cursor measurements (the value measured with the cursor is displayed on screen) using the Cursor Exec soft key when the cursor type is Vertical History.

Note

- An error occurs if the cursor type is something other than Vertical History or if a cursor measurement (the value measured with the cursor is displayed on screen) was not performed.

Notes when Saving the Results of the Cursor Measurement Values

The restrictions are as follows.

- Up to (32000/the number of items that are turned ON) data points before the point at which the save operation is executed are saved. However, the data points that are saved are limited to those that are acquired after fixing T/div, V/div, and Measure settings.
- Output example

DL1600						
	X1	X2	DX	1/DX		
	S	S	S	Hz		
	-2.000E-02	2.000E-02	4.000E-02	2.500E+01		
	Y1(C1)"	Y1(C2)"	Y1(C3)"	Y1(C4)"		
	V	V	V	V		
Max	8.333E-02	1.042E+00	4.167E-02	4.167E-02		
Min	-2.083E+00	-1.021E+00	-4.167E-02	-2.083E-02		
Avg	-1.499E+00	2.481E-02	-1.086E-02	1.589E-03		
Sdv	8.613E-01	6.281E-01	1.610E-02	1.218E-02		
Cnt	2.360E+02	2.360E+02	2.360E+02	2.360E+02		
	-235	-2.042E+00	1.021E+00	0.000E+00	0.000E+00	Oldest data
	-234	0.000E+00	-2.083E-02	0.000E+00	0.000E+00	↓
	-233	-8.833E-02	0.000E+00	0.000E+00	0.000E+00	
	-232	4.167E-02	-2.083E-02	0.000E+00	2.083E-02	
	-231	4.167E-02	0.000E+00	2.083E-02	2.083E-02	
	
	
	Newest data

For information related to cursors, see section 9.1, "Measuring Waveforms Using Cursors."

11.10 Saving the Cursor Measurement Values

Data Size

Data size = Number of measurement items × 15 × number of history waveforms

File Extension

The file extension is .CSV.

The selection of the medium and directory, file name, comments, auto naming function, specification of the files to be displayed in the File List dialog box, and properties are the same as those for saving/loading normal waveform data. For explanation and procedures, see section 11.6, "Saving/Loading Waveform Data."

Note

- If a key other than the **Abort** key is pressed during saving, an error occurs.
 - This function can not be used in conjunction with the FTP server, FTP client, LPR client, or Web server functions.
-

11.11 Changing the File Attributes, Deleting Files



CAUTION

Never remove the medium or turn OFF the power while the access indicator or storage medium icon is blinking. This can damage the medium or destroy the data on the medium.

Relevant Keys

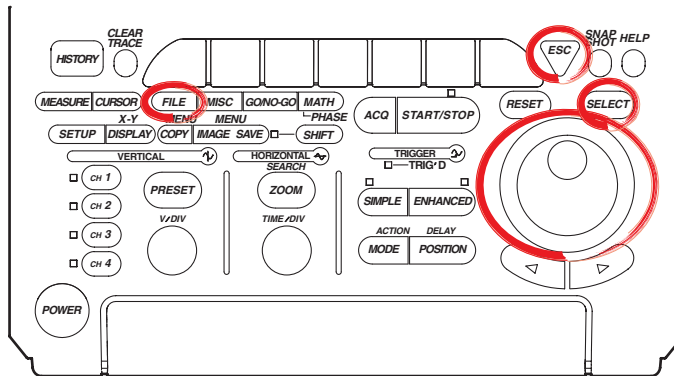

Operating Procedure

1. Press **FILE**.
2. Pressing the **Utility** soft key displays the utility setting menu and the file list dialog box.

File Item			Save	Load		FILE
Setup						Utility

Selecting the Destination Medium/Directory

The procedures are the same as steps 13 to 17 in section 11.6, "Saving/Loading Waveform Data."

Changing the File Attributes

3. Pressing the **Function** soft key displays the file function menu.

Function						Utility
Format	Media Info		Format			FILE

4. Press the **Delete** soft key.

						Utility
Delete	Copy	Rename	Make Dir	Format	Attr	FILE
						Delete Exec

5. Turn the jog shuttle to select a file.

11.11 Changing the File Attributes, Deleting Files

Note

By selecting a screen image data file (files with the .tif, .bmp, .ps, .jpg, or .png extensions) in the File List window and pressing **SELECT**, the selected screen image file's compressed image appears in the upper right portion of the file list.

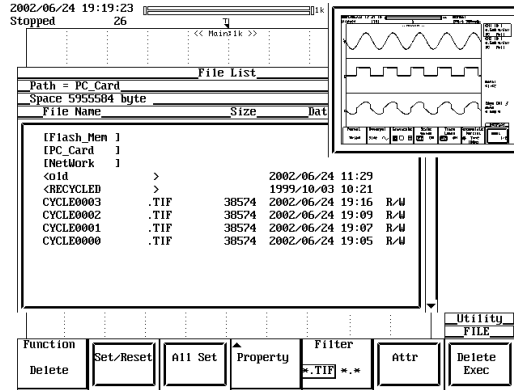

- If compressed image (thumbnail) data does not exist for the selected file, an error message appears. Pressing **ESC** clears the error message.
- The following procedure clears the compressed image from the screen.
 - Move the cursor using the jog shuttle.

6. Pressing the **Attr** soft key changes the attribution of the selected file.

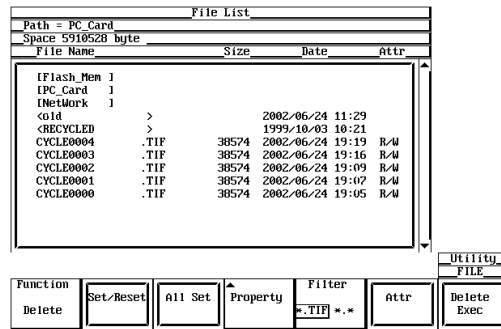

Selecting the Files to be Deleted One at a Time

7. Turn the jog shuttle to select a file.
8. Pressing the **Set/Reset** soft key places an asterisk (*) to the left of the selected file. The file will be deleted. Pressing the **Set/Reset** soft key again removes the asterisk (*) to the left of the selected file. The file will not be deleted.

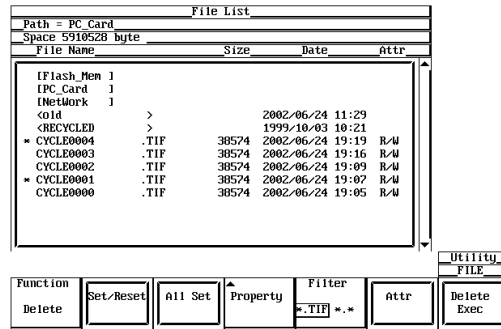

Go to step 12.

Selecting All Files to be Deleted

9. Turn the jog shuttle to select a file, a directory, or a medium.
10. Pressing the **All Set** soft key places an asterisk to the left of every file in the directory containing the selected file or directory. These files will be deleted. The name of the **All Set** soft key changes to **All Reset**.
11. Pressing the **All Set** soft key removes the asterisk to the left of every file in the directory containing the selected file or directory. These files will not be deleted. The name of the **All Reset** soft key changes to **All Set**.

Deleting the Files

12. Press the **Delete Exec** soft key. All files with the asterisks are deleted.

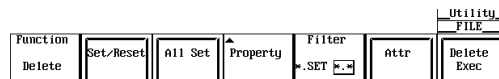
**Specifying the File to be Displayed in the File List Dialog Box, Viewing the Properties**

The procedures are the same as steps 30 to 33 in section 11.6, “Saving/Loading Waveform Data.”

Explanation**Selecting the Medium and Directory**

The storage medium that can be used to save and load waveform data are displayed in the File List dialog box.

- **Display Example of Storage Medium**

- Flash_Mem : Internal flash memory
- PC_Card : PC card
- FD : Floppy disk
- ZIP : Zip disk
- NetWork : Network drive (available with the Ethernet interface option)
- USB : USB storage

Selecting the File Attributes (Excepting Net Drive)

Select the attributes for each file from the following choices.

- R/W
Read and write possible.
- R
Read only. Cannot write to the file or delete the file.

Selecting the Files to be Deleted

You can delete all files that have an asterisk to the left of the file name. There are two methods available to select the files that are to be deleted.

- **Selecting the Files One at a Time**

Place an asterisk to the left of the file names one at a time, using the **Set/Reset** soft key.

- **Selecting All Files at Once**

Selecting a file or directory and pressing the **All Set** soft key places an asterisk on every file in the directory containing the selected file or directory.

Specifying the File to be Displayed in the File List Dialog Box

You can specify the type of files to display.

- *. extension
Displays only the data file that was selected in the File Item setting menu and the data type menu.
- *.*
Displays all the files on the medium.

Properties

Lists the file name.extension, file size, the date it was saved, the attributes, and the comment for the selected file.

Displaying Compressed Images in the File List

Selecting screen image data files from the File List causes a compressed image of the screen data to appear in the upper right portion of the File List. Screen image data is the only type of compressed image that is displayed. The compressed images of waveform and setting data are not displayed. Also, file name and color information are not displayed in the compressed image.

Note

- You cannot delete files while data acquisition is in progress
 - Deleted data cannot be recovered. Make sure not to erase the wrong files.
 - Directories can be deleted if there are no files in them.
 - If an error occurs while deleting multiple files, the files after the error will not be deleted.
 - Directory attributes cannot be changed.
 - This function can not be used in conjunction with the FTP server, FTP client, LPR client, or Web server functions.
 - Screen image data and thumbnail display data is saved together as a file pairs. If you set the designation (filter) of the files displayed in the file list to *.* then process (Delete, Rename, Copy) each file individually, the thumbnail function becomes disabled.
-

11.12 Copying Files



CAUTION

Never remove the medium or turn OFF the power while the access indicator or storage medium icon is blinking. This can damage the medium or destroy the data on the medium.

Relevant Keys

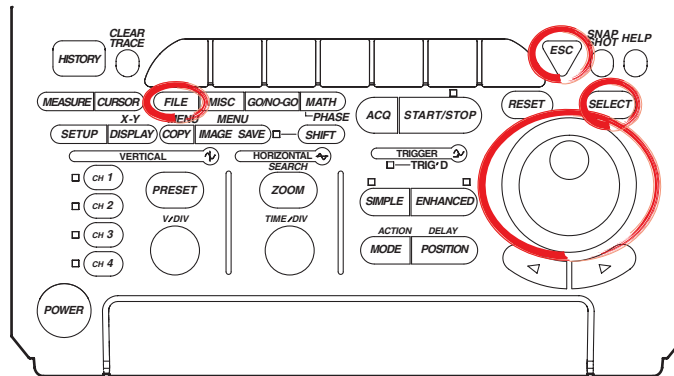

Operating Procedure

1. Press **FILE**.
2. Pressing the **Utility** soft key displays the utility setting menu and the file list dialog box.

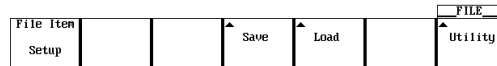

3. Pressing the **Function** soft key displays the file function menu.

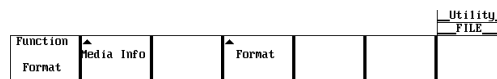

4. Press the **Copy** soft key.

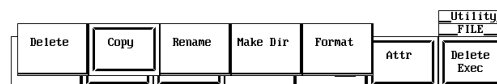

Selecting the Source Medium/Directory

5. The procedures are the same as steps 13 to 17 in section 11.6, "Saving/Loading Waveform Data."

Selecting the Source File One at a Time

6. Turn the jog shuttle to select a file.

Note

By selecting a screen image data file (files with the .tif, .bmp, .ps, .jpg, or .png extensions) in the File List window and pressing **SELECT**, the selected screen image file's compressed image appears in the upper right portion of the file list.

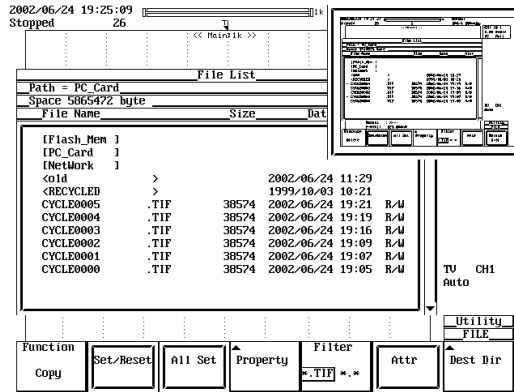

- If compressed image (thumbnail) data does not exist for the selected file, an error message appears. Pressing **ESC** clears the error message.
- The following procedure clears the compressed image from the screen.
- Move the cursor using the jog shuttle.

7. Press the **Set/Reset** soft key. If an asterisk is displayed to the left of the file name in the File List dialog box, the file will be copied.

If you press the **Set/Reset** soft key, the asterisk to the left of the file name disappears. This file will not be copied.

Go to step 11.

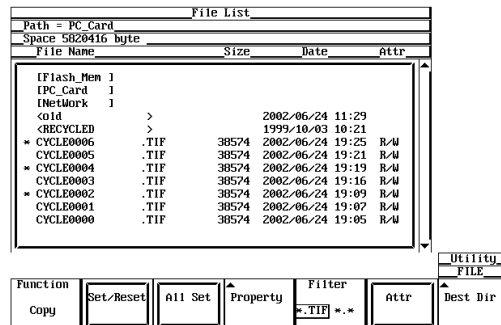

Selecting All Copy Source Files at Once

8. Turn the jog shuttle to select a file, a directory, or a medium.
9. Pressing the **All Set** soft key places an asterisk to the left of every file in the directory containing the selected file or directory. These directories and files will be copied. The name of the **All Set** soft key changes to **All Reset**.

Resetting All Selected Copy Source

10. Pressing the **All Reset** soft key removes the asterisk to the left of every file in the directory containing the selected file or directory. The directories and files will not be copied. The name of the **All Reset** soft key changes to **All Set**.

Selecting the Copy Destination

11. Press the **Dest Dir** soft key. The copy execution menu and the copy destination file list dialog box appear.

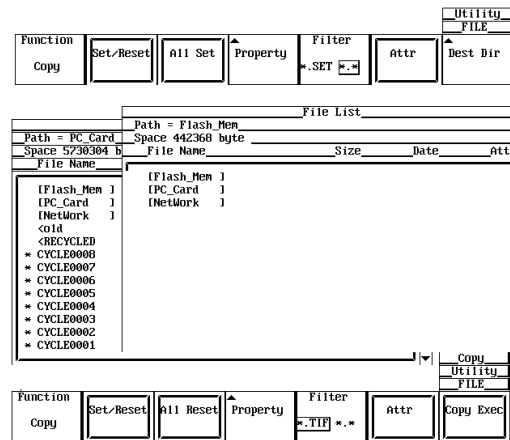

Selecting the Destination Medium/Directory

12. The procedures are the same as steps 13 to 17 in section 11.6, “Saving/Loading Waveform Data.”

Executing the Copy Operation

13. Press the **Copy Exec** soft key to copy all source files that have an asterisk.

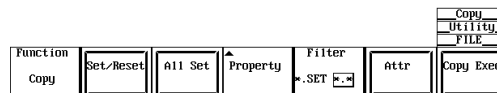

Specifying the File to be Displayed in the File List Dialog Box and Viewing its Properties

The procedures are the same as steps 30 to 33 in section 11.6, “Saving/Loading Waveform Data.”

Explanation

Selecting the Copy Source Files

You can copy all files that have an asterisk to the left of the file name. There are two methods available to select the files that are to be copied.

- **Selecting the Files One at a Time**

Place an asterisk to the left of the file names one at a time, using the **Set/Reset** soft key.

- **Selecting All Files at Once**

Selecting a file or directory and pressing the **All Set** soft key places an asterisk on every file in the directory containing the selected file or directory.

Specifying the File to be Displayed in the File List Dialog Box

You can specify the type of files to display.

- *. extension

Displays only the data file that was selected in the File Item setting menu and the data type menu.

- **

Displays all the files on the medium.

Properties

Lists the file name.extension, file size, the date it was saved, the attributes, and the comment for the selected file.

Displaying Compressed Images in the File List

Selecting screen image data files from the File List causes a compressed image of the screen data to appear in the upper right portion of the File List. Screen image data is the only type of compressed image that is displayed. The compressed images of waveform and setting data are not displayed. Also, file name and color information are not displayed in the compressed image.

Note

- You cannot copy files while the data acquisition is in progress.
 - If an error occurs while copying multiple files, the files after the error will not be copied.
 - Directory attributes cannot be changed.
 - If a file with the same name exists at the destination, copying is not allowed.
 - You cannot copy the same files to another directory immediately after copying those files. You must again select the files you wish to copy.
 - This function can not be used in conjunction with the FTP server, FTP client, LPR client, or Web server functions.
 - Screen image data and thumbnail display data is saved together as a file pairs. If you set the designation (filter) of the files displayed in the file list to *.* then process (Delete, Rename, Copy) each file individually, the thumbnail function becomes disabled.
-

11.13 Changing the Directory/File Name of the Storage Medium and Creating a Directory



CAUTION

Never remove the medium or turn OFF the power while the access indicator or storage medium icon is blinking. This can damage the medium or destroy the data on the medium.

Relevant Keys

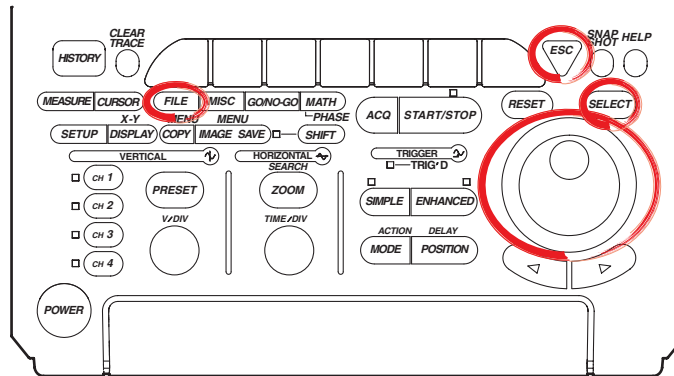

Operating Procedure

1. Press **FILE**.
2. Pressing the **Utility** soft key displays the utility setting menu and the file list dialog box.

File Item			Save	Load		FILE Utility
Setup						

3. Pressing the **Function** soft key displays the file function menu.

Function						Utility FILE
Format	Media Info		Format			

4. Press the **Rename** soft key.

Delete	Copy	Rename	Make Dir	Format		Utility FILE

Changing the Directory/File Name of the Storage Medium

Selecting the Medium/Directory

5. The procedures are the same as steps 13 to 17 in section 11.6, "Saving/Loading Waveform Data."

Changing the File Attributes

6. The procedures are the same as steps 6 and 7 in section 11.11, "Changing the File Attributes, Deleting Files."

11.13 Changing the Directory/File Name of the Storage Medium and Creating a Directory

Changing the directory/file name of the recording medium (excepting Net Drive)

7. Turn the jog shuttle to select directory, or file.

Note

By selecting a screen image data file (files with the .tif, .bmp, .ps, .jpg, or .png extensions) in the File List window and pressing **SELECT**, the selected screen image file's compressed image appears in the upper right portion of the file list.

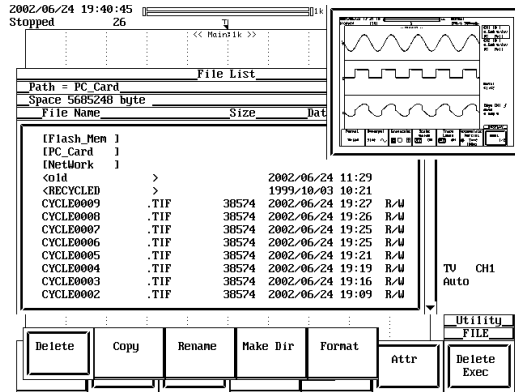

- If compressed image (thumbnail) data does not exist for the selected file, an error message appears. Pressing **ESC** clears the error message.
- The following procedure clears the compressed image from the screen.
 - Move the cursor using the jog shuttle.

8. Pressing the **File Name** soft key displays a keyboard. The name of directory/file is displayed in the entry box of the keyboard.

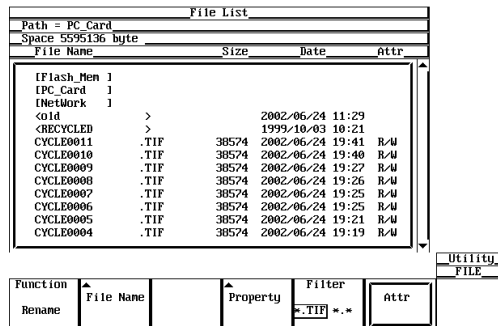

9. Enter the directory/file name according to the procedures given in section 4.1.

Specifying the File to be Displayed in the File List Dialog Box, Viewing the Properties

The procedures are the same as steps 30 to 33 in section 11.6, "Saving/Loading Waveform Data."

Creating a Directory

Follow steps 1-3 to display the file function selection menu.

4. Press the soft key corresponding to **Make Dir**.

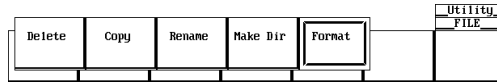

Selecting the Medium/Directory

5. The procedures are the same as steps 13 to 17 in section 11.6, "Saving/Loading Waveform Data."

Creating the Directory

6. Turn the jog shuttle to select a medium or a directory.
7. Pressing the **Dir Name** soft key displays a keyboard.

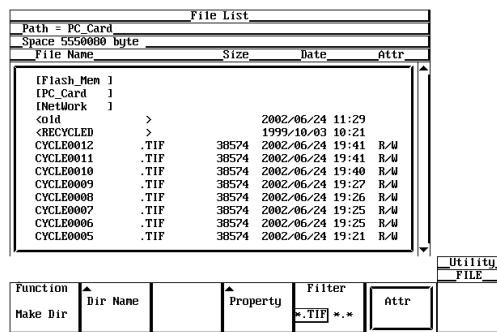

8. Enter the directory/file name according to the procedures given in section 4.1.

Specifying the File to be Displayed in the File List Dialog Box, Viewing the Properties

The procedures are the same as steps 30 to 33 in section 11.6, "Saving/Loading Waveform Data."

Explanation

Selecting the Medium and Directory

The storage medium that can be used to save and load waveform data are displayed in the File List dialog box.

- **Display Example of Storage Medium**

- Flash_Mem : Internal flash memory
- PC_Card : PC card
- FD : Floppy disk
- ZIP : Zip disk
- NetWork : Network drive (available with the Ethernet interface option)
- USB : USB storage

Selecting the File Attributes

Select the attributes for each file from the following choices.

- R/W
Read and write possible.
- R
Read only. Cannot write to the file or delete the file.

11.13 Changing the Directory/File Name of the Storage Medium and Creating a Directory

Changing the Directory/File Name of the storage medium

Number and types of characters that can be used

Item	Number of Characters	Characters that can be Used
File name	1 to 16 chars.	0 to 9, A to Z, %, _, () (parenthesis), -(minus sign)

However, a directory name that starts with "ND" (ND000 for example) is not allowed.

Creating a Directory

A new directory can be created on a medium. See above for the assignment of the directory name when creating a new directory.

Specifying the File to be Displayed in the File List Dialog Box

You can specify the type of files to display.

- *. extension
Displays only the data file that was selected in the File Item setting menu and the data type menu.
- *.*
Displays all the files on the medium.

Properties

Lists the file name.extension, file size, the date it was saved, the attributes, and the comment for the selected file.

Displaying Compressed Images in the File List

Selecting screen image data files from the File List causes a compressed image of the screen data to appear in the upper right portion of the File List. Screen image data is the only type of compressed image that is displayed. The compressed images of waveform and setting data are not displayed. Also, file name and color information are not displayed in the compressed image.

Note

- You cannot rename a directory/file or create a new directory while the data acquisition is in progress (START/STOP indicator is ON).
 - Directory attributes cannot be changed.
 - If a file with the same name exists in the same directory, renaming is not allowed.
 - If a directory with the same name exists in the same directory, the directory cannot be created.
 - This function can not be used in conjunction with the FTP server, FTP client, LPR client, or Web server functions.
 - Screen image data and thumbnail display data is saved together as a file pairs. If you set the designation (filter) of the files displayed in the file list to *.* then process (Delete, Rename, Copy) each file individually, the thumbnail function becomes disabled.
-

12.1 External Trigger Input, External Clock Input



CAUTION

Never apply signals that do not meet the following specifications as this may damage the instrument (due to overvoltage, for example).

External Trigger Input Terminal

[Input Terminal]

DL1640/DL1640L
Rear Panel
EXT CLOCK IN
EXT TRIG IN
 $\leq 40\text{Vpk } 1\text{M}\Omega$



DL1620
Front Panel

$1\text{M}\Omega/28\text{PF} < 40\text{Vpk } 1\text{M}\Omega$



This terminal is used when an external signal is used as a trigger source. (See section 6.2)

Specifications

Connector Type:	BNC
Maximum Input Voltage:	at $\pm 40\text{ V}$ (DC + AC peak) or 28 Vrms , when the frequency is 10 kHz or less.
Frequency Range:	DC to 100 MHz
Input Impedance:	approx. $1\text{ M}\Omega$ and 28 pF
Input Range:	$\pm 2\text{ V}$ (for the DL1640/DL1640L) $\pm 1\text{ V}$ (for the DL1620 with the $\pm 1\text{ V}$ range selected) $\pm 10\text{ V}$ (for the DL1620 with the $\pm 10\text{ V}$ range selected)
Trigger Sensitivity:	0.3 Vp-p (for the DL1640/DL1640L) 0.1 Vp-p at DC to 100MHz (for the DL1620 with the $\pm 1\text{ V}$ range selected) 1 Vp-p at DC to 100MHz (for the DL1620 with the $\pm 10\text{ V}$ range selected)
Trigger Level:	$\pm 2\text{ V}$ in 5 mv resolution (for the DL1640/DL1640L) $\pm 1\text{ V}$ in 5 mv resolution (for the DL1620 with the $\pm 1\text{ V}$ range selected) $\pm 10\text{ V}$ in 50 mv resolution (for the DL1620 with the $\pm 10\text{ V}$ range selected)

External Clock Input Terminal

[Input Terminal]

DL1640/DL1640L
Rear Panel
EXT CLOCK IN
EXT TRIG IN
 $\leq 40\text{Vpk } 1\text{M}\Omega$



DL1620
Front Panel

$1\text{M}\Omega/28\text{PF } \leq 40\text{Vpk } 1\text{M}\Omega$



The external trigger input terminal can also be used as an external clock input terminal. If you wish to drive the instrument with an external clock, connect a clock signal to this terminal.

Specifications

Connector Type:	BNC
Maximum Input Voltage:	at $\pm 40\text{ V}$ (DC + AC peak) or 28 Vrms, when the frequency is 10 kHz or less.
Frequency Range:	40 Hz to 5 MHz (continuous clock only)
Input Impedance:	approx. $1\text{ M}\Omega$ and 28 pF
Input Range:	$\pm 2\text{ V}$ (for the DL1640/DL1640L) $\pm 1\text{ V}$ (for the DL1620 with the $\pm 1\text{ V}$ range selected) $\pm 10\text{ V}$ (for the DL1620 with the $\pm 10\text{ V}$ range selected)
Threshold Level:	$\pm 2\text{ V}$ in 5 mv resolution (for the DL1640/DL1640L) $\pm 1\text{ V}$ in 5 mv resolution (for the DL1620 with the $\pm 1\text{ V}$ range selected) $\pm 10\text{ V}$ in 50 mv resolution (for the DL1620 with the $\pm 10\text{ V}$ range selected)
Minimum Input Amplitude:	0.3 Vp-p (for the DL1640/DL1640L) 0.1 Vp-p (for the DL1620 with the $\pm 1\text{ V}$ range selected) 1 Vp-p (for the DL1620 with the $\pm 10\text{ V}$ range selected)
Minimum Pulse Width:	10 ns for both High and Low.

12.2 Trigger Output (TRIG OUT)



CAUTION

Never apply an external voltage to the TRIG OUT terminal. This may damage the instrument.

TRIG OUT Terminal

TRIG OUT
(TTL ⌋)



This trigger outputs a TTL level signal when a trigger occurs. The signal level is normally high, but goes low when a trigger occurs.

Specifications

Connector Type: BNC
Output Level: TTL
Output Logic: ⌋(negative)
Output Delay Time: 50 ns or less
Output Hold Time: 1 μ s min at low level, 100 ns min at high level

Output Circuit Diagram

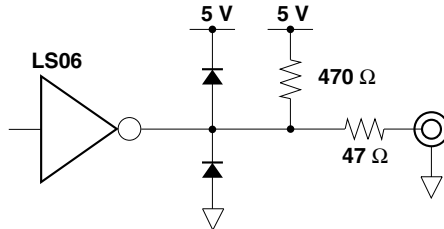

Timing Chart

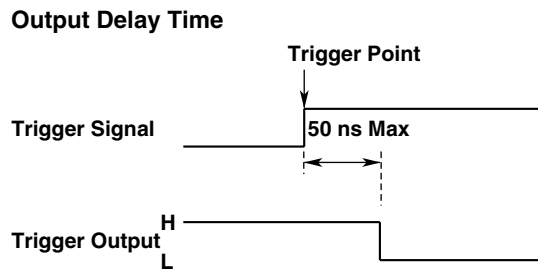

12.2 Trigger Output (TRIG OUT)

Low Level/High Level Hold Time

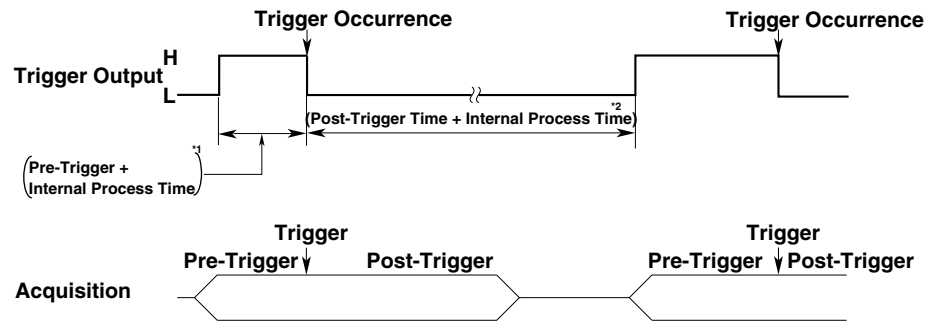

*1: HIGH (High Level) Period

Indicates the pre-trigger and internal processing time. 100 ns minimum.

*2: LOW (Low Level) Period

Indicates the post-trigger and internal processing time. 1 μ s minimum.

12.3 RGB Video Signal Output (RGB VIDEO OUT)



CAUTION

- When making a connection, turn OFF the DL1620/DL1640/DL1640L and the monitor.
- Never short circuit the RGB VIDEO OUT terminal or apply an external voltage. This may damage the instrument.

RGB VIDEO OUT Terminal



VIDEO OUT (VGA)

Through RGB output, the contents displayed on the instrument can be displayed on an external monitor. Monitors that can be connected are VGA monitors or multi-synchronous monitors that can display VGA.

Specifications

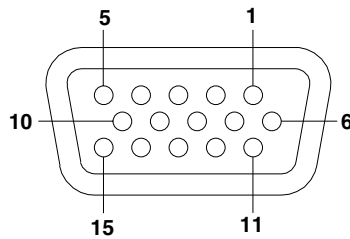

D-Sub 15-Pin Receptacle

Pin No.	Signal	Specification
1	Red	0.65 Vp-p
2	Green	0.65 Vp-p
3	Blue	0.65 Vp-p
4	—	
5	—	
6	GND	
7	GND	
8	GND	
9	—	
10	GND	
11	—	
12	—	
13	Horizontal synchronous signal	Approx. 31.3 kHz, TTL negative logic
14	Vertical synchronous signal	Approx. 60 Hz, TTL negative logic
15	—	

12.3 RGB Video Signal Output (RGB VIDEO OUT)

Connecting the Monitor

1. Turn OFF the DL1620/DL1640/DL1640L and the monitor.
2. Connect the monitor to the DL1620/DL1640/DL1640L using an analog RGB cable.
3. Turn ON the DL1620/DL1640/DL1640L and the monitor. The instrument's screen is displayed on the monitor.

Note

- The RGB VIDEO OUT terminal outputs RGB video signal at all times.
 - The picture on the monitor may flicker if the DL1620/DL1640/DL1640L or another instrument is brought too close to the monitor.
 - The ends of the screen may be cut off on some monitors.
-

12.4 Using the CH1 OUT Signal

Output Specifications for the CH1 OUT Signal

Connector type	: BNC
Input level	: 20 mV/div \pm 30% (with 50 Ω termination)
Frequency bandwidth	: Approx. 20 MHz DC (-3 dB)
Offset deviation	: \pm 20 mV

Output Signal Terminal

The terminal labeled CH1 OUT on the rear panel.



Notes About Signal Output

For the output level, the vertical center of the voltage axis in the waveform display frame is taken as 0 V.

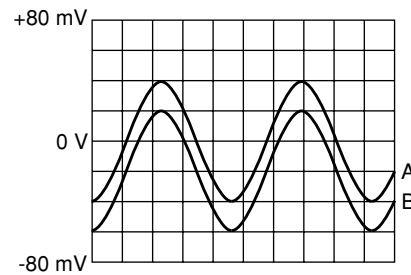

- For waveform A, output is an 80 mVp-p signal with an offset of 0 V.
- For waveform B, output is an 80 mVp-p signal with an offset of -20 mV.

- The output level does not change even if sensitivity of the voltage axis is changed.
- If the CH1 trigger level is set to any value other than 0 div, output may be distorted.
- When HF Reject is selected for the CH1 trigger, the bandwidth is limited to about 15 kHz.
- When NTSC, PAL, SECAM, or 480/60p is selected as the video signal format for the TV trigger, the bandwidth is limited to about 300 kHz.



CAUTION

- Do not apply voltage externally to the CH1 OUT terminal. Doing so may damage the terminal.

13.1 Connecting the DL1620/DL1640/DL1640L to a Personal Computer/Workstation through an Ethernet Interface (Option)

Ethernet Interface Specifications

A 100BASE-TX port is provided on the rear panel of the DL1620/DL1640/DL1640L.

Item	Specifications
Communication Port Number	1
Electrical-Mechanical Specifications	IEEE 802.3 standards
Transmission Method	Ethernet (100BASE-TX/10BASE-T)
Transmission Rate	Max. 100 Mbps
Communication Protocol	TCP/IP
Supported Services	FTP server, FTP client (network drive), LPR client (network printer), SMTP client (mail transmission), DHCP, DNS, SNTP, WebDAV
Connector Type	RJ-45 connector

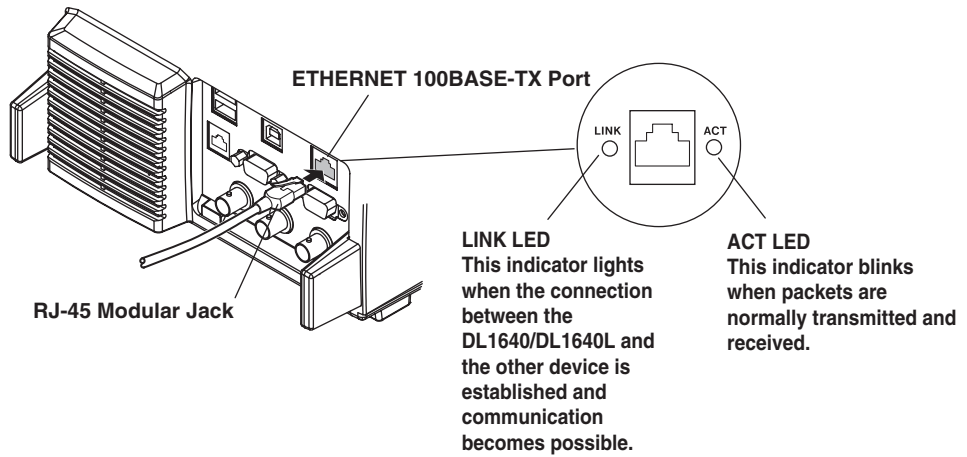

Items Necessary for Connection

Cable

Use only the following cables for connection.

- UTP (unshielded twisted-pair) cable (category 5)
- STP (shielded twisted-pair) cable

13.1 Connecting the DL1640/DL1640L to a Personal Computer/Workstation through an Ethernet Interface (Option)

Connection Method

When Connecting to a Network PC or Workstation

1. Turn OFF the power to the instrument.
2. Connect one side of the UTP (or STP) cable to the ETHERNET 100BASE-TX terminal on the rear panel.
3. Connect the other end of the UTP (or STP) cable to a hub or router.
4. Turn ON the power to the instrument.

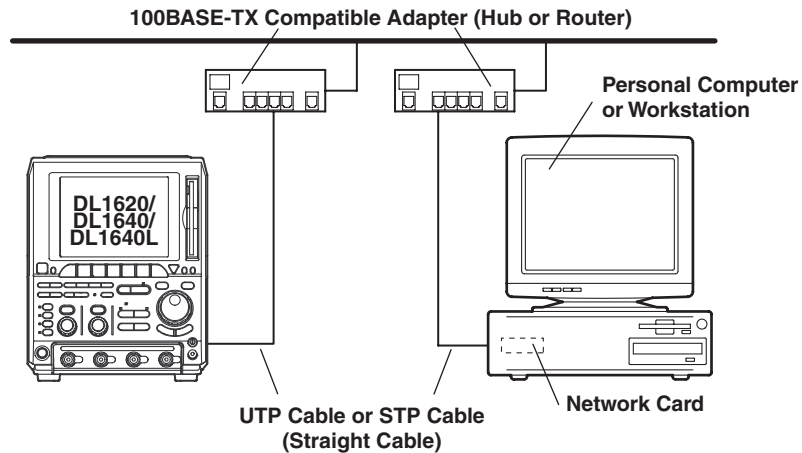

When Making a One-to-One Connection to the PC or Workstation

1. Turn OFF the power to the instrument and PC or workstation.
2. Connect one side of the UTP (or STP) cable to the ETHERNET 100BASE-TX terminal on the rear panel.
3. Connect the other end of the UTP (or STP) cable to a hub or router.
4. In the same manner, connect the PC or workstation to a hub or router.
5. Turn ON the power to the instrument.

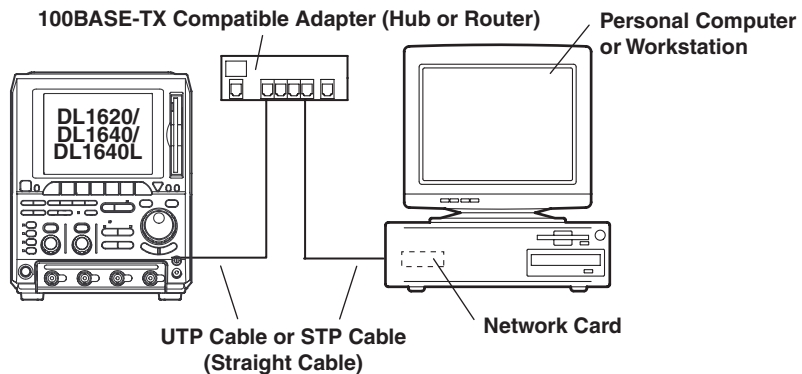

Note

- When connecting the PC or workstation one-to-one, a network card (a 10BASE-T/100BASE-TX autoswitching card) is required for the PC or workstation.
- When using a UTP cable (straight cable), be sure to use only a category 5 cable.
- Avoid connecting the PC or workstation directly to the instrument without going through the hub or router. We cannot guarantee results using a direct connection.

13.2 Configuring the Ethernet Interface (TCP/IP)

Relevant Keys

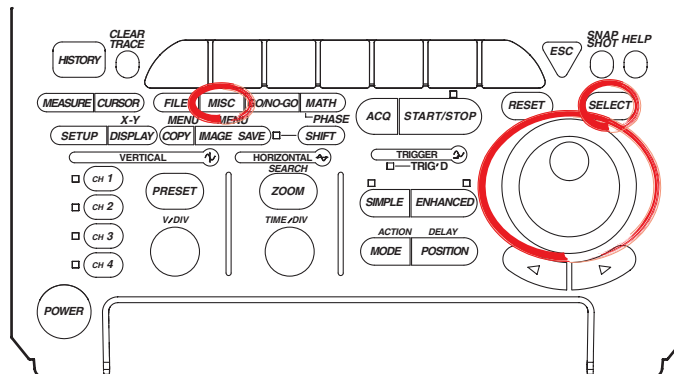

Operating Procedure

1. Press **MISC**.
2. Press the **Network** soft key to display the Network menu.

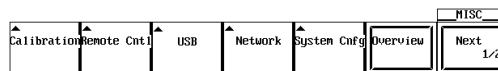

3. Press the **TCP/IP Setup** soft key to display the TCP/IP settings menu.

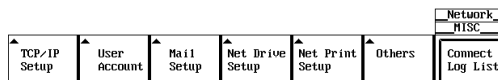

DHCP ON/OFF

4. Move the cursor to DHCP using the jog shuttle and press **SELECT** to turn DHCP ON or OFF. If you select ON, then it is not necessary to set the IP address, subnet mask, and default gateway. If you wish to set up the DNS, please skip to step 11. If you do not wish to set up the DNS, check the network cable connection and restart the DL1620/DL1640/DL1640L. The IP address, subnet mask, and default gateway are automatically set.

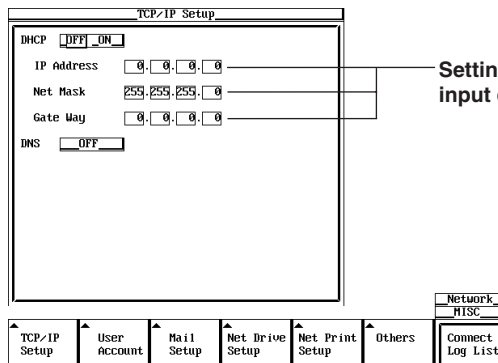

Setting the IP Address

Set the IP address if you turned DHCP OFF in step 4.

5. Move the cursor to the IP Address field with the jog shuttle, and press **SELECT** to display the settings menu.
6. Enter the IP address values from 0 to 255 using the jog shuttle.

13.2 Configuring the Ethernet Interface (TCP/IP)

Setting the Subnet Mask

Set the subnet mask if you turned DHCP OFF in step 4.

7. Move the cursor to the Net Mask field using the jog shuttle, and press **SELECT** to display the settings menu.
8. Enter the subnet mask address values from 0 to 255 using the jog shuttle.

Setting the Default Gateway

Set the default gateway if you turned DHCP OFF in step 4.

9. Move the cursor to the Gate Way field with the jog shuttle, and press **SELECT** to display the settings menu.
10. Enter the default gateway address values from 0 to 255 using the jog shuttle.

Setting the DNS

11. Move the cursor to DNS by turning the jog shuttle.
12. Press **SELECT** to display the DNS setting menu.

The screenshot shows the 'TCP/IP Setup' menu. At the top, 'DHCP' is set to 'OFF'. Below it are fields for 'IP Address', 'Net Mask' (set to 255.255.255.0), and 'Gate Way'. The 'DNS' option is selected, and a sub-menu is displayed with 'OFF' and 'ON' options. At the bottom, there is a navigation bar with buttons for 'TCP/IP Setup', 'User Account', 'Mail Setup', 'Net Drive Setup', 'Net Print Setup', 'Others', and 'Network MISC'. The 'Network MISC' button is highlighted, and a sub-menu with 'Connect Log List' is visible.

13. Press **SELECT** to set the DNS to ON, OFF, or AUTO (AUTO available only when DHCP is ON). When DNS is set to AUTO, the domain name and DNS server name are automatically set by restarting the instrument. If DNS is set to ON, the domain name, DNS server name, and domain suffix are displayed. If DNS is set to OFF, check the network cable connection and restart the DL1620/DL1640/DL1640L.

The screenshot shows the 'TCP/IP Setup' menu with 'DNS' set to 'ON'. Below this, there are input fields for 'Domain Name', 'DNS Server1', 'DNS Server2', 'Domain Suffix1', and 'Domain Suffix2'. A callout box with a keyboard icon points to these fields, stating: 'Settings for the following items can be input directly using a USB keyboard. (⌨)'. The navigation bar at the bottom is the same as in the previous screenshot.

14. Move the cursor to Domain Name by turning the jog shuttle.
15. Press **SELECT** to display the keyboard.
16. Input the domain name.
17. Move the cursor with the jog shuttle to the DNS Server 1 field, and press **SELECT** to display the setting menu.
18. Set the primary DNS server values from 0 to 255 using the jog shuttle.

19. In the same manner, set the secondary DNS server in the DNS Server 2 field.
20. Move the cursor to Domain Suffix1 by turning the jog shuttle.
21. Press **SELECT** to display the keyboard.
22. Input the primary domain suffix.
23. In the same manner, set the secondary domain suffix in the domain suffix 2 field.

Note

For keyboard (soft keyboard) operation see section 4.1, "Entering Values and Character Strings."

Turning the Power ON/OFF

24. You must restart the DL1620/DL1640/DL1640L for the settings to take affect. After all the settings are complete, turn the power to the DL1620/DL1640/DL1640L OFF, then back ON again.

Explanation

The following TCP/IP settings must be entered to use the Ethernet communications functions on the DL1620/DL1640/DL1640L.

- IP Address
- Subnet Mask
- Default Gateway

IP Address (Internet Protocol Address)

Assign an IP address to the instrument. The default setting is 0.0.0.0.

A unique IP address must be assigned to each PC on an IP network such as the internet or an intranet. The address is a 32-bit value normally expressed with four values (0-255), each separated by a period as in 192.168.111.24.

Obtain an IP address from your network administrator. The settings are automatically configured in environments using DHCP.

Subnet Mask

Specify the mask that is used to determine the network address from the IP address. The default setting is 255.255.255.0.

Huge TCP/IP networks such as the internet are often divided up into smaller networks called subunits. The subnet mask is a 32 bit value that specifies whether to use an IP address containing some number of bits that identify the network address. The portion other than the network address is the host address that identifies which computer on the network the address belongs to.

Consult the network administrator for the subnet mask setting value. In some cases, this setting may not be necessary. The settings are automatically configured in environments using DHCP.

Default Gateway

Set the IP address of the gateway (default gateway) for communicating with machines on different networks. The default setting is 0.0.0.0.

The default gateway has control functions that handle protocol exchanges when communicating on multiple networks, and that smoothly carry out sending and receiving of data.

Consult your network administrator for the default gateway setting values. In some cases, this setting may not be necessary. The settings are automatically configured in environments using DHCP.

DHCP (Dynamic Host Configuration Protocol)

DCHP is a protocol that allocates necessary setting information to all PCs connected to the network. When DHCP is ON, the following settings are automatically assigned.

- IP Address
- Subnet Mask
- Default Gateway
- DNS

To use DHCP, you must have a DHCP server installed on the network. Inquire with your network administrator to find out if you can use DCHP.

When DHCP is set to ON, different settings may be assigned each time the power is turned ON. Therefore when using the FTP server function (see section 13.8), be sure to check the IP address and other settings of the instrument on the PC or workstation each time you turn ON the instrument.

DNS (Domain Name System)

The DNS is a system that correlates the host name/domain name to the IP address. (Given AAA.BBBBB.co.jp, AAA is the hostname, and BBBBB.co.jp is the domain name.) The host/domain name can be used instead of a numeric IP address when accessing the network.

On the DL1620/DL1640/DL1640L, you can specify the host by name instead of by IP address when using the FTP client function (see sections 13.3 and 13.4) or the LPR client function (see section 13.5).

Set the domain name, the DNS server address (default is 0.0.0.0), and the domain suffix. In networks that support DHCP, these settings can be configured automatically. Consult your network administrator for details on the settings.

- **DNS Server**

Up to two DNS servers can be specified (primary and secondary). If the primary server is down, the secondary server is used to search the host name/domain name and IP address.

- **Domain Suffix**

If the IP address corresponding to the domain name described in the previous paragraph is not found on the DNS server, then it may be that the system is configured to use another domain name. Set this other domain name as a domain suffix. Up to two domain suffixes can be specified, DomainSuffix1 (primary), and DomainSuffix2 (secondary).

Note

- To change this menu setting, you must restart the DL1620/DL1640/DL1640L.
- When the Ethernet cable is not connected, if you turn ON the power to the DL1620/DL1640/DL1640L while DCHP is ON, there is a possibility of malfunction in the communications or file functions. Turn DHCP OFF and restart the instrument.

- **Configuring the TCP/IP Settings of the PC**

Communications parameters such as the IP address must be specified also on the PC side. Communications parameters are specified for each Ethernet NIC that is installed in the PC. Here, the settings of the NIC for connecting your PC and the DL1620/DL1640/DL1640L are explained.

If the IP address and other parameters are to be obtained dynamically using the DHCP server, the following settings are not necessary. In this case, select Obtain an IP address automatically under the IP Address tab of the TCP/IP Properties dialog box.

For example, if you are connecting a PC and the DL1620/DL1640/DL1640L to an independent Ethernet network, you can specify parameters as indicated in the next table.

For details on the parameters, consult your system or network administrator.

Parameter	Value	Note
IP Address	Example: 192.168.21.128	IP address for the PC
Subnet Mask	Example: 255.255.255.0	Set the same value as the subnet mask that was specified for the DL1620/DL1640/DL1640L.
Gateway	None	
DNS	Disable	
WINS	Disable	

The following procedure describes the steps for Windows 95/98/Me. If you are using Windows NT/2000 Professional/XP carry out equivalent steps according to your operating system.

1. Select Settings > Control Panel from the Start menu to open the Control Panel folder.
2. Double-click the Network icon to display the following Network dialog box.
3. Click the Configuration to select the TCP/IP connection corresponding to the Ethernet NIC that is connected to the PC and click Properties to display the TCP/IP properties dialog box.

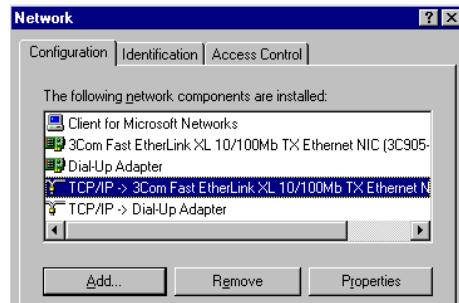

4. Set the parameters such as the IP address according to the table on the previous page and click OK.

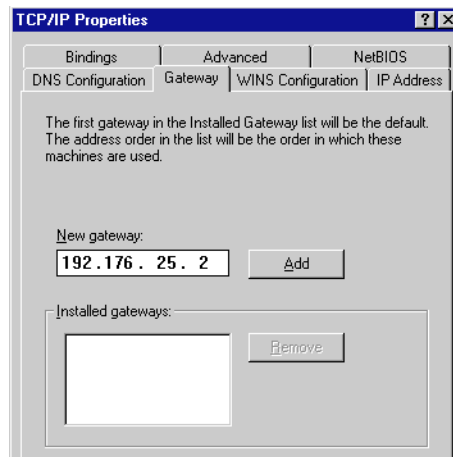
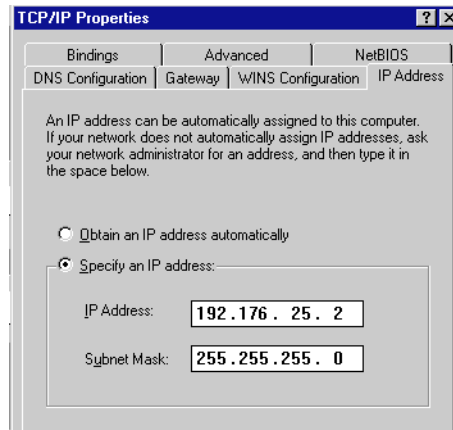

13.3 Saving and Loading Waveform and Setting Data to and from a Network Drive (FTP Client Function)

<For a description of this function, see page 1-30>

Relevant Keys

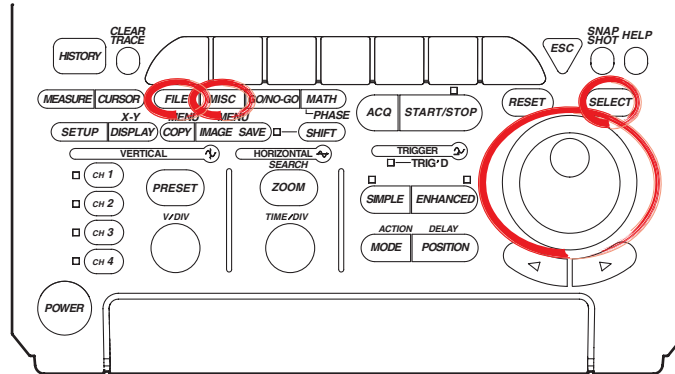

Operating Procedure

Entering Settings for a Network Drive

1. Press **MISC**.
2. Press the **Network** soft key and press the **Net Drive Setup** soft key to display the settings menu.

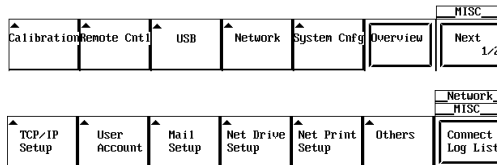

3. Use the jog shuttle to move the cursor to FTP Server, then press **SELECT** to display the keyboard.

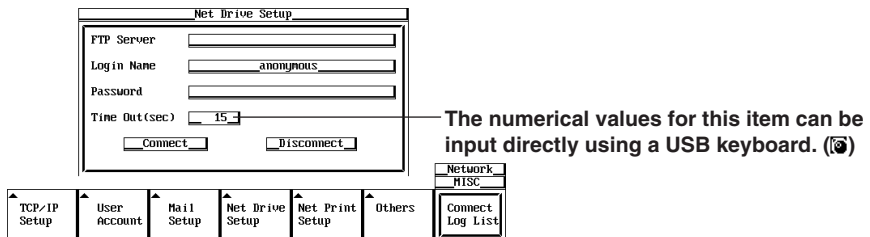

4. Enter the IP address of the FTP server. When using DNS, you can specify it by name.
5. Use the jog shuttle to move the cursor to Login Name, then press **SELECT** to display the keyboard.
6. Enter a login name of 15 characters or less.
7. Use the jog shuttle to move the cursor to Password, then press **SELECT** to display the keyboard.

13.3 Saving and Loading Waveform and Setting Data to and from a Network Drive (FTP Client Function)



- Enter a password of 15 characters or less for the login name. If the login name is anonymous, you don't need to enter a password.

- Use the jog shuttle to move the cursor to Timeout. Press **SELECT** to set the timeout time. The available setting range is 0 to 3600(s).

Note

- For keyboard (soft keyboard) operation see section 4.1, "Entering Values and Character Strings."
- If Login Name is set to anonymous, it is not necessary to enter a password.

Connecting/Disconnecting to a Network Drive

- Use the jog shuttle to move the cursor to Connect, then press **SELECT** to make the connection. If the connection has been made successfully the  icon appears in the upper right part of the screen.
Use the jog shuttle to move the cursor to Disconnect, then press **SELECT** to close the connection. The  icon in the upper right of the screen is turned off.

Saving/Loading the Waveform and the Setting Data

- Press **FILE** and press the **Utility** soft key to display the File List.

- Use the jog shuttle to move the cursor to NetWork.

File List			
Path = NetWork			
Space 2147483647 byte			
File Name	Size	Date	Attr
(Flash_Mem]			
(ZIP]			
(NetWork]			
<Network >		2002/07/15 11:46	
<Software >		2002/07/09 09:23	
<Mail >		2002/06/28 10:09	
<Utilities >		2002/06/25 18:20	
<Documents >		2002/06/20 15:37	
<Desktop >		2001/10/17 00:00	
<resource.frk >		2001/08/10 00:00	
06720006	.TIF	38574	2002/07/12 09:15
06720003	.TIF	38574	2002/07/12 09:13
06720004	.TIF	38574	2002/07/12 09:13

- For the remaining procedures, please see section 11.7, "Saving/Loading Setup Data" through section 11.13, "Changing the Directory/File Name of the Storage Medium and Creating a Directory."

13.3 Saving and Loading Waveform and Setting Data to and from a Network Drive (FTP Client Function)

Note

- You must run FTP server software on PCs and workstations that will be connected to the network. Also, please note the following regarding the server software:
 - Use UNIX format for list output (character strings returned by the *dir* command).
 - Make the home directory and its subdirectories writable.
 - You can't change to a higher directory than the home directory.
 - The newest file is not necessarily displayed at the top of the file list.
 - You cannot access files or directories having names longer than seventeen or more characters.
 - Depending on the server, the < . . > notation for the top directory may not be displayed.
 - In the following cases, the time information in a file list will not be displayed accurately:
 - When Windows NT uses an AM or PM timestamp.
 - When using a server that returns kanji or other non-ASCII character strings in a list.
 - The following are not possible:
 - Turning file protect ON and OFF on saved files.
 - Formatting a network drive.
 - Copying between network drives.
 - Renaming a file on the network.
 - This function can not be used in conjunction with the FTP server or Web server functions.
 - Before saving data to a network drive, you must configure TCP/IP (see 13.2, "Configuring the Ethernet Interface (TCP/IP)").
 - When connected to the network, you must disconnect then reconnect for settings to take effect.
 - When you are disconnected by the server when using the FTP client, you will be automatically reconnected if you perform a file operation (save, load, etc.) This is the same if Network Drive is selected for Save to File when using an action trigger or GO/NO-GO.
 - The time it takes to load waveform data from a network drive depends on the status of the network. If there is enough space on your storage medium, copy the waveform data to the storage media before loading it, reducing loading time.
-

Explanation

You can save data such as waveform and settings data to network drives via Ethernet in the same manner as with floppy disks or Zip disks.

Entering Settings for a Network Drive

- **FTP Server**
Input the IP address of the FTP server (the PC or workstation running the FTP server) on the network to which waveform and setting data will be saved. On networks supporting DNS, you can specify the host and domain by name instead of by IP address.
- **Login Name**
Enter a login name of 15 characters or less. The default value is anonymous. The available characters consist of all ASCII characters on the keyboard (including space).
- **Password**
Enter a password corresponding to the login name using 15 characters or less. The available characters consist of all ASCII characters on the keyboard (including space).
- **Time Out**
When accessing the FTP server from this instrument, if can't receive even after a fixed time (the timeout time) elapses, this means that the instrument is unable to send to or receive from the FTP server, and the connection will close. The available setting range is 0 to 3600 s. The default setting is 15 s.

13.4 Saving Screen Image Data to a Network Drive (FTP Client Function)

<For a description of this function, see page 1-30>

Relevant Keys

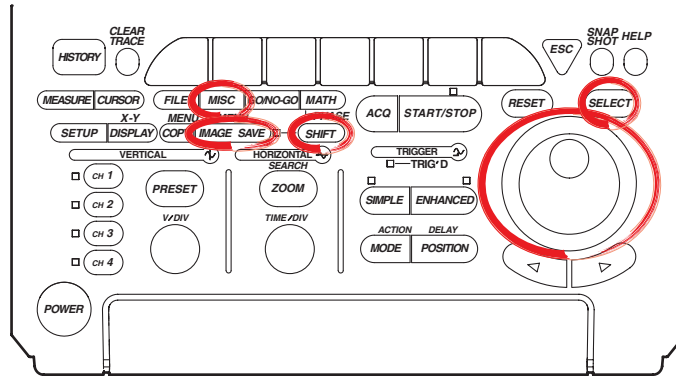

Operating Procedure

Entering Settings for a Network Drive

1. Press **MISC**.
2. Press the **Network** soft key and press the **Net Drive Setup** soft key to display the settings menu.

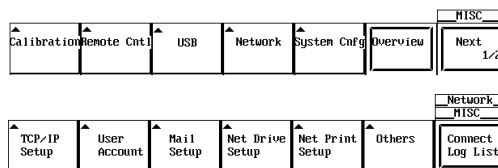

3. Use the jog shuttle to move the cursor to FTP Server, then press **SELECT** to display the keyboard.

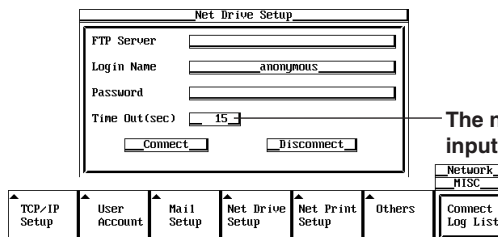

The numerical values for this item can be input directly using a USB keyboard. (Ⓜ)

4. Enter the IP address of the FTP server address. If you are using DNS, you can specify it by name.
5. Use the jog shuttle to move the cursor to Login Name, then press **SELECT** to display the keyboard.
6. Enter a login name of 15 characters or less.
7. Use the jog shuttle to move the cursor to Password, then press **SELECT** to display the keyboard.

13.4 Saving Screen Image Data to a Network Drive (FTP Client Function)

- Enter the password of 15 characters or less for the login name.

- Use the jog shuttle to move the cursor to Timeout, then press **SELECT** to set the timeout time. The available setting range is 0 to 3600(s).

Note

- For keyboard (soft keyboard) operation see section 4.1, "Entering Values and Character Strings."
- If Login Name is set to anonymous, it is not necessary to enter a password.

Connecting to a Network Drive

- Use the jog shuttle to move the cursor to Connect, then press **SELECT** to make the connection. If the connection was made successfully, the  icon appears in the upper right of the screen.

Saving the Screen Image

- Press **SHIFT** to activate shift mode. Functions marked in purple on the panel become active.
- Press **IMAGE SAVE**.
- Press the **File List** soft key to display the File List, and select Network.

File Name	Size	Date	Attr
[Flash_Men]			
[ZIP]			
[Network]			
<Network >		2002/07/15 11:46	
<Software >		2002/07/09 09:23	
<RAI >		2002/06/28 10:09	
<Utilities >		2002/06/25 18:20	
<Documents >		2002/06/20 15:37	
<Desktop >		2001/10/17 00:00	
<resource.frk >		2001/08/10 00:00	
06720006 .TIFF	38574	2002/07/12 09:15	
06720003 .TIFF	38574	2002/07/12 09:13	
06720004 .TIFF	38574	2002/07/12 09:13	

- For the remaining procedures, please see 11.7, "Saving/Loading Setup Data" through section 11.13, "Changing the Directory/File Name of the Storage Medium and Creating a Directory."

Note

- You must run FTP server software on PCs and workstations that will be connected to the network. Also, please note the following regarding the server software:
 - Use UNIX format for list output (character strings returned by the *dir* command).
 - Make the home directory and its subdirectories writable.
 - You can't change to a higher directory than the home directory.
 - The newest file is not necessarily displayed at the top of the file list.
 - You cannot access files or directories having names longer than seventeen or more characters.
 - Depending on the server, the < . . > notation for the top directory may not be displayed.
 - In the following cases, the time information in a file list will not be displayed accurately:
 - When Windows NT uses an AM or PM timestamp.
 - When using a server that returns kanji or other non-ASCII character strings in a list.
 - The following are not possible:
 - Turning file protect ON and OFF on saved files.
 - Formatting a network drive.
 - Copying between network drives.
 - Renaming a file on the network.
 - This function can not be used in conjunction with the FTP server or Web server functions.
 - Before saving data to a network drive, you must configure TCP/IP (see "13.2 Configuring the Ethernet Interface (TCP/IP)").
 - When connected to the network, you must disconnect then reconnect for settings to take effect.
 - When you are disconnected by the server when using the FTP client, you will be automatically reconnected if you perform a file operation (save, load etc.) This is the same if Network Drive is selected for Save to File when using an action trigger or GO/NO-GO.
-

Explanation

You can save a screen image to a network drive via Ethernet just as you would to a floppy disk drive or Zip drive.

Entering Settings for a Network Drive

- **FTP Server**

Input the IP address of the FTP server (the PC or workstation running the FTP server) on the network to which screen image data will be saved. On networks supporting DNS, you can specify the host and domain by name instead of by IP address.
- **Login Name**

Enter a login name of 15 characters or less. The default value is anonymous. The available characters consist of all ASCII characters on the keyboard (including space).
- **Password**

Enter a password corresponding to the login name using 15 characters or less. The available characters consist of all ASCII characters on the keyboard (including space).
- **Time Out**

When accessing the FTP server from this instrument, if can't receive even after a fixed time (the timeout time) elapses, this means that the instrument is unable to send to or receive from the FTP server, and the connection will close. The available setting range is 0 to 3600 s. The default setting is 15 s.

13.5 Sending Screen Image Data to a Network Printer (LPR Client Function)

<For a description of this function, see page 1-30>

Relevant Keys

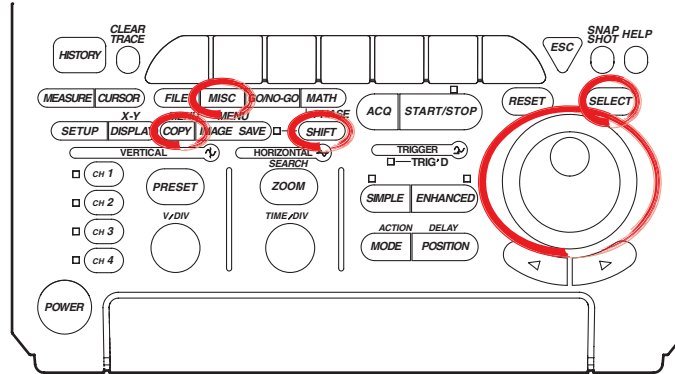

Operating Procedure

Entering Settings for a Network Printer

1. Press **MISC**.
2. Press the **Network** soft key, then press the **Net Print Setup** soft key to display the settings menu.

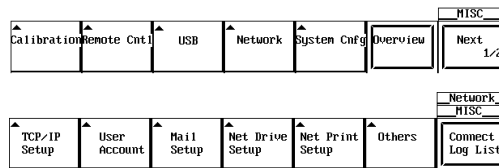

3. Use the jog shuttle to move the cursor to LPR Server, then press **SELECT** to display the keyboard.

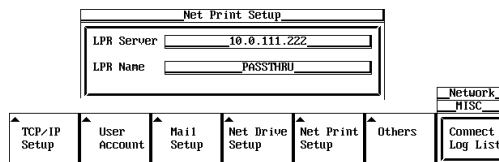

4. Enter the printer server address. If you are using a DNS, specify it by name.
5. Use the jog shuttle to move the cursor to LPR Name, then press **SELECT** to display the keyboard.
6. Enter the printer name.

Note

For keyboard (soft keyboard) operation see section 4.1, "Entering Values and Character Strings."

Outputting the Screen Image Data

7. Press **SHIFT** to set the keys in the shifted condition. Functions marked in purple on the panel become active.
8. Press **COPY**.

13.5 Sending Screen Image Data to a Network Printer (LPR Client Function)

9. Press the **Copy to** soft key to select **Net Print**.

Copy to	Format	Information	Comment				COPY
Built-in	Normal	Long	OFF	ON			
Built-in	USB	Net Print	Comment				COPY

10. For the remaining procedures, please see 10.3, "Outputting Screen Image to a USB Printer."

However, when NetPrint is selected, PS is added to the Format item.

Copy to	Format	Color	Comment				COPY
Net Print	ESC-P	OFF	ON				
Copy to	PS	LIPS3	PCL5	ESC-P	ESC-P2	BJ	
Net Print							

Note

- Before using this function, see section 13.2, "Configuring the Ethernet Interface (TCP/IP)" and enter the TCP/IP settings.
- You can output to any TCP/IP compatible printer.
- This function can not be used in conjunction with the FTP server or Web server functions, or the File operation.

Explanation

You can send screen images simultaneously to a network printer via Ethernet, and the built in printer (optional).

Entering Settings for a Network Printer

• LPR Server

Specify the IP address of the network printer server. On networks supporting DNS, you can specify the host and domain by name instead of by IP address.

• Printer Name (LPR Name)

Specify the name of the printer to which screen images will be output.

Printer Format

The following six printer formats are supported.

- ESC-P
- ESC-P2
- LIPS3
- PCL5
- BJ
- PS (PostScript)

13.6 Using the Mail Function (Fixed Interval)

<For a description of this function, see page 1-31>

Relevant Keys

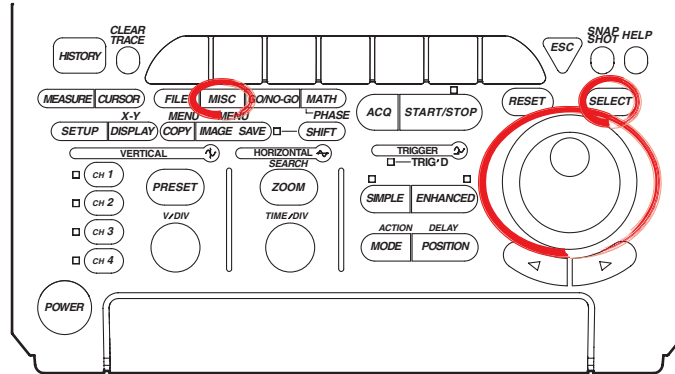

Operating Procedure

Mail Settings

1. Press **MISC**.
2. Press the **Network** soft key to display the Network menu.

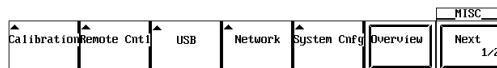

3. Press the **Mail Setup** soft key to display the mail settings menu.

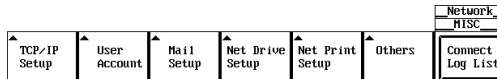

4. Move the cursor to Mail Server using the jog shuttle, then press **SELECT** to display the keyboard.

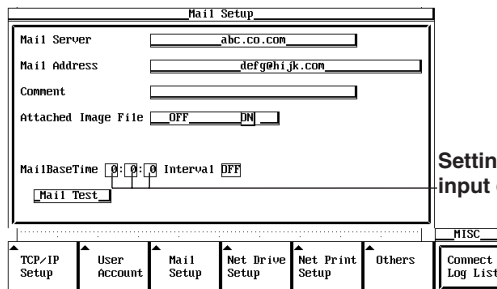

Settings for the following items can be input directly using a USB keyboard. (Ⓜ)

5. Enter the mail server name. If you are using a DNS, specify it by name.
6. Move the cursor to Mail Address using the jog shuttle, then press **SELECT** to display the keyboard.
7. Enter the mail address of 40 characters or less.
8. If necessary, move the cursor to Comment using the jog shuttle, then press **SELECT** to display the keyboard.
9. Enter a comment or 30 characters or less.
10. Move the cursor to Attached Image File using the jog shuttle, then press **SELECT** to display the keyboard.
11. Press **SELECT** to select either ON (attach image file) or OFF (do not attach image file).

12. Move the cursor to Mail Base Time using the jog shuttle, then press **SELECT** to display the keyboard.
13. Enter the mail transmission time.
14. Move the cursor to Interval using the jog shuttle, then press **SELECT** to select the mail interval.

Sending a Test Mail Transmission

15. Move the cursor to Mail Test with the jog shuttle, then press **SELECT** to send a test transmission to the specified mail recipient.

Note

- For keyboard (soft keyboard) operation see section 4.1, "Entering Values and Character Strings."
- For mail sent by this instrument, the sender's address will be the same as the specified recipient address.
- When error history is included in the mail's contents, the most recent errors appear at the top.
- Before using this function, see section 13.2, "Configuring the Ethernet Interface (TCP/IP)" and enter the TCP/IP settings.
- If you set [Interval] to OFF, mail is not transmitted at specified intervals.

Explanation

You can transmit DL1620/DL1640/DL1640L status information to a specified e-mail address on the network at periodic intervals.

Mail Settings

- **Mail Server**

Specify the IP address of the network mail server. On networks supporting DNS, you can specify the host and domain by name instead of by IP address.

- **Mail Address**

Enter the address of the mail recipient using 40 characters or less.

Attaching Image Files (Version 1.13 or Later)

When sending mail, you can attach screen images. The file format of screen image files is fixed at PNG. Color is ON (256 colors). For details about the image format, see section 10.4, "Storing Screen Image to the External Storage Medium."

The file name is DL_image.png.

When the screen image file is attached by an Action ON trigger or a GO/NO-GO determination as in the next section, the file name is automatically assigned in the format DL_nnnn.png (where nnnn is a number from 0001 to 1000).

- **Comment**

The comment appears on the first line of mails that are sent. Comments are optional. Use 30 characters or less for the comment.

- **MailBaseTime**

Specify the time to start transmitting the e-mail messages. Set the time in units of hour : minute : second in the following range.

0 : 0 : 0 to 23 : 59 : 59

- **Interval**

The allowable mail transmission intervals are as follows:

Off / 1H / 2H / 3H / 4H / 6H / 8H / 12H / 24H

When OFF is selected, transmission at specified intervals is not possible.

Sending a Test Mail

Sends a test mail to the address specified by Mail Address.

13.6 Using the Mail Function (Fixed Interval)

Data Sent from the DL1620/DL1640/DL1640L

The following four items are sent.

- **Acquisition status**
Start/Stop, trigger status, acquisition counter
- **Error log information**
Error number, and up to 16 lines of the English error message text
- **GO/NO-GO success/fail information**
Time of GO/NO-GO determination only (see sections 9.9 and 9.10)
- **Results of waveform parameter measurement**
Automatic measurement of waveform parameters (see sections 9.2 and 9.4), and the time of GO/NO-GO determination by waveform parameters only (see section 9.9)

Sample Transmission:

```
[Comment]   aaaaaa
```

```
[ACQ Status]   Stopped   162
```

```
[GO/NOGO Status]   Success: 140   Fail: 21
```

```
Max (C1)   4.16667V  
SDv (C2)   697.941mV  
Freq(C3)   500.0000kHz  
+Wd (C4)   1.00us>
```

```
ErrNo 004 Completed GO/NO-GO.
```

```
ErrNo 886 GO/NO-GO is in execution. Please press the Abort key.
```

```
ErrNo 004 Completed GO/NO-GO.
```

```
ErrNo 886 GO/NO-GO is in execution. Please press the Abort key.  
Stop.
```

13.7 Using the Mail Function (Action Mail Function)

<For a description of this function, see page 1-31>

Relevant Keys

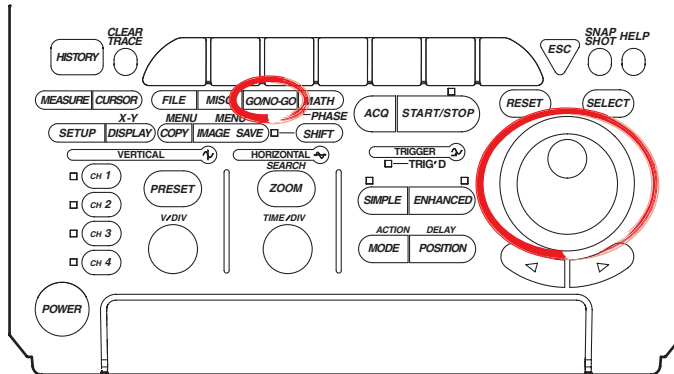

Operating Procedure

Mail Settings

1. Follow steps 1 through 9 in section 13.6, "Using the Mail Function (Fixed Interval)" to input the MailServer, MailAddress, and a Comment if necessary.
2. It is not necessary to set the MailBaseTime and Interval using the action mail function. However, turn Interval OFF when only using the action mail function without using the fixed interval mail function.

Setting the Action

3. Press **GO/NO-GO**.
4. Press the **MODE** soft key then select **Zone** or **Parameter**.

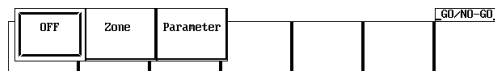

5. Press the **Setup** soft key to display the GO/NO-GO setting menu.

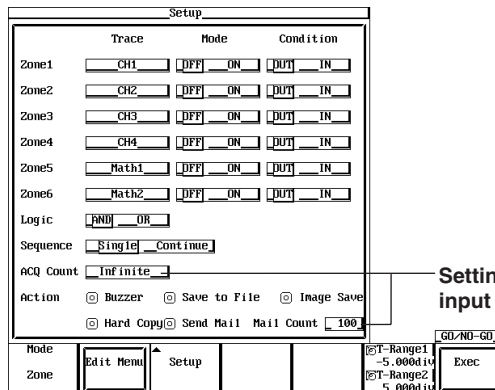

Settings for the following items can be input directly using a USB keyboard. (F3)

13.7 Using the Mail Function (Action Mail Function)

6. Use the jog shuttle to move the cursor to Action, and select Send Mail.
7. Select Mail Count to set a limit for the number of mails that are sent.
8. Press the **Exec** soft key to start GO/NO-GO.

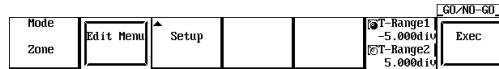

Note

- The e-mail destination is the Mail Address set in **MISC**, NetWork, Mail Setup.
- For mail sent by this instrument, the sender's address will be the same as the specified recipient address.
- This function can be used in conjunction with 13.6, "Using the Mail Function (Fixed Interval)." Turn the Interval OFF only when using the action mail function.
- Before using this function, see section 13.2, "Configuring the Ethernet Interface (TCP/IP)" and enter the TCP/IP settings.

Explanation

You can send the trigger time and other information to the specified network mail address as the action of a GO/NO-GO determination or an action trigger.

Mail Settings

For details, see section 13.6, "Using the Mail Function (Fixed Interval)."

- **Attaching Image Files, Version 1.13 or Later**

If the attach screen image data setting was selected using the procedure in section 13.6, "Using the Mail Function (Fixed Interval)," the current screen image is attached every time an e-mail is sent. The file name is automatically assigned in the format DL_nnnn.png (where nnnn is a number from 0001 to 1000).

Data Sent from the DL1620/DL1640/DL1640L

The following five items are sent.

- **Acquisition status**
Start/Stop, acquisition counter
- **Trigger time**
- **GO/NO-GO success/fail information**
Time of GO/NO-GO determination only (see sections 9.9 and 9.10)
- **Cause of failure**
Time of GO/NO-GO determination only (see sections 9.9 and 9.10)
- **Results of waveform parameter measurement**
Automatic measurement of waveform parameters (see sections 9.2 and 9.4), and the time of GO/NO-GO determination by waveform parameters only (see section 9.9)

Sample Transmission Report

```
[Comment]      aaaaaa
[ACQ Status]   Stopped    1
[Trigger Date and Time]  2000/07/17   17:28:59.38
[GO/NOGO Status]   Success: 9   Fail: 1
[NOGO Factor]    Param4(Ch4,tWd )
Max (C1)      4.16667V
SDv (C2)     697.941mV
Freq(C3)     500.0000kHz
+Wd (C4)     1.00us>
```

13.8 Accessing DL1620/DL1640/DL1640L Drives from a Network Drive (FTP Server Function)

<For a description of this function, see page 1-30>

Relevant Keys

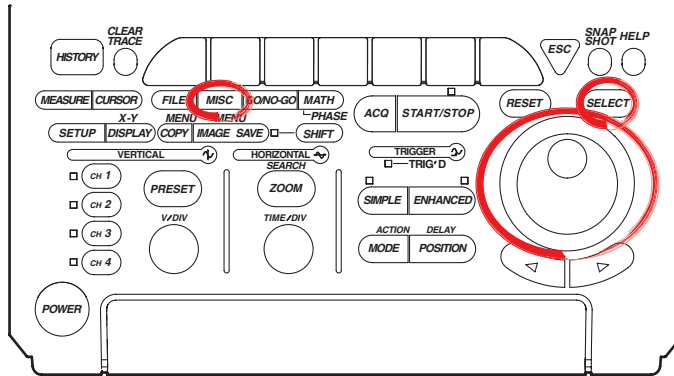

Operating Procedure

User Account Settings

1. Press **MISC**.
2. Press the **Network** soft key to display the Network menu.

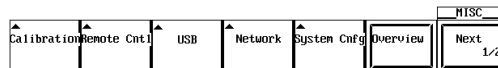

3. Press the **User Account** soft key to display the account settings menu.

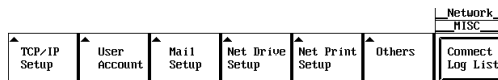

4. Move the cursor to **User Name** using the jog shuttle, then press **SELECT** to display the keyboard.

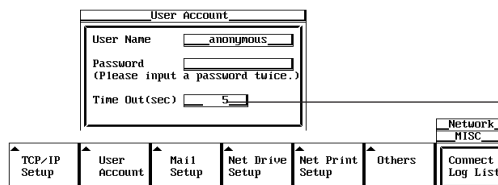

The numerical values for this item can be input directly using a USB keyboard. (Ⓜ)

5. Enter the user name. If you do not wish to limit access, use the anonymous setting. If access is to be limited, enter a user name of 15 characters or less.
6. Move the cursor to Password using the jog shuttle, then press **SELECT** to display the keyboard.
7. Enter the password. Enter the same password again. If the user name is set to anonymous, it is not necessary to enter a password.
8. Move the cursor to Timeout using the jog shuttle, then press **SELECT**.
9. Enter the Timeout time using the jog shuttle. If the DL1620/DL1640/DL1640L is not being accessed at the Timeout time, the connection to the network will be automatically closed.

Note

For keyboard (soft keyboard) operation see section 4.1, "Entering Values and Character Strings."

13.8 Accessing DL1640/DL1640L Drives from a Network Drive (FTP Server Function)

Executing the FTP Client Software

- Execute the FTP client software from a personal computer or workstation. Perform file operations using the username specified in step 6.

Displaying the Connection Logging List

- When you press the **Connection Logging List** soft key, the 25 most recent access times, user names, and IP addresses are displayed.

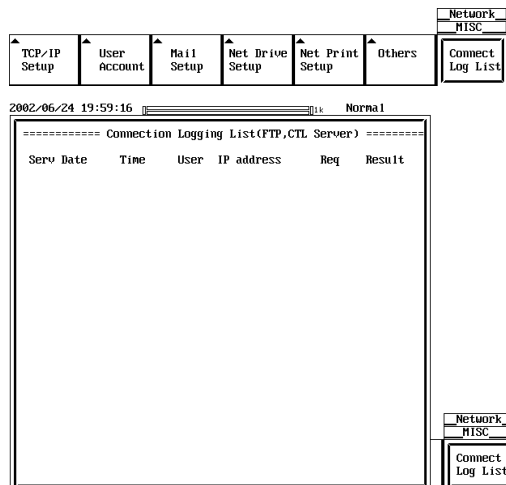

Note

- The DL1620/DL1640/DL1640L supports two clients, but they cannot be used simultaneously.
- When the DL1620/DL1640/DL1640L is being accessed from a PC or workstation (i.e. when it's logged on),  is displayed in the upper right part of the screen.
- This function can not be used in conjunction with the FTP client, LPR client, or Web server functions, or the File operation.
- The log is cleared when the power is turned OFF.
- Before accessing a drive, see 13.2, "Configuring the Ethernet Interface (TCP/IP)" and enter the TCP/IP settings.
- You must restart the DL1620/DL1640/DL1640L for the settings to take effect.
- The files taken from a personal computer or workstation to the DL1620/DL1640/DL1640L have .wvf, .hdr, and .set extensions.

Explanation

You can access the DL1620/DL1640/DL1640L's Zip drive, floppy drive, PC card, internal flash memory drive, or USB storage from a PC or workstation via Ethernet. In order to access these devices, you must be running FTP client software on the PC or workstation.

User Account Settings

- User Name**
15 characters or less may be used. The default value is anonymous.
The available characters consist of all ASCII characters on the keyboard (including space).
- Password**
15 characters or less may be used.
The available characters consist of all ASCII characters on the keyboard (including space).
- Time Out**
If the instrument is not being accessed at the time specified here, the connection to the network will be automatically closed.
The default setting is 5 s. If you are using an FTP client software, set a longer value here.

13.9 Viewing the Ethernet Interface Option and MAC Address

Relevant Keys

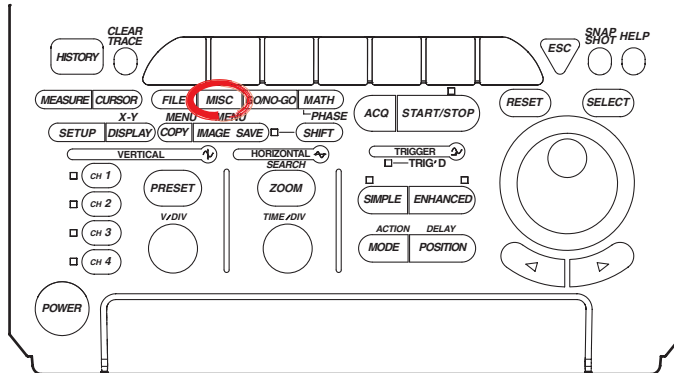

Operating Procedure

1. Press **MISC**.
2. Press the **Overview** soft key.

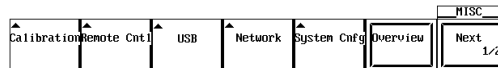

3. When Ether:Yse(/C7) appears for the Option item in the overview screen, this indicates that the Ethernet interface is installed. The number on the right side is the MAC address (in the example, MAC:000064_830_051).

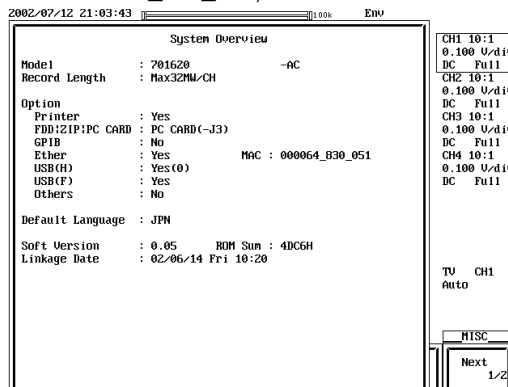

Note

- Ether: Yes (/C7) is only displayed if the Ethernet interface option is installed.
- If XXXXXX_XXX_XXX is displayed for your MAC address, contact your nearest YOKOGAWA dealer.

Explanation

Check the MAC address, and whether the Ethernet interface (optional) is installed.

The Presence of the Ethernet Interface (Option)

The presence of the Ethernet interface is displayed under Ethernet in the Information window.

- If Yes is displayed, the Ethernet interface is installed.
- If No is displayed, the Ethernet interface is not installed.

MAC Address

The MAC address is a unique address that has already been set on the instrument, and is necessary for transmission between nodes.

13.10 Setting the FTP Passive Mode and LPR/SMTMP Timeout

Relevant Keys

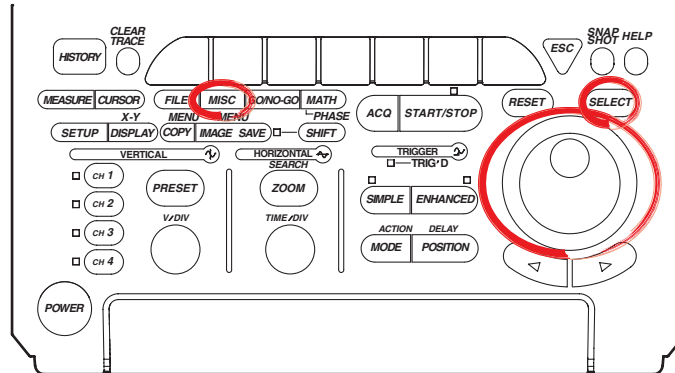

Operating Procedure

1. Press **MISC**.
2. Press the **Network** soft key to display the Network menu.

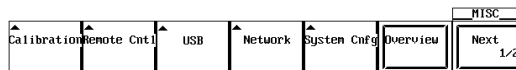

3. Press the **Others** soft key to display the Others settings menu.

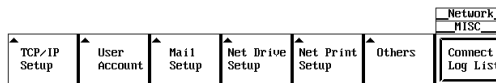

Turning ON/OFF the FTP Passive Mode

4. Turn the jog shuttle to select FTP Passive.

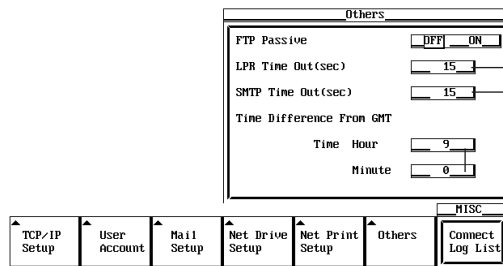

Settings for the following items can be input directly using a USB keyboard. (Ⓜ)

5. Press **SELECT** to select ON or OFF.

Setting the LPR Timeout Time

4. Turn the jog shuttle to select LPR Time Out.
5. Press **SELECT** to display the timeout time selection box.
6. Turn the jog shuttle to set the timeout time.
7. Press **SELECT** or **ESC** to close the box.

Setting the SMPT Timeout Time

4. Turn the jog shuttle to select SMTP Time Out.
5. Press **SELECT** to display the timeout time selection box.
6. Turn the jog shuttle to set the timeout time.
7. Press **SELECT** or **ESC** to close the box.

Explanation

Enters special settings related to the FTP client, LPR, and SMTP. Normally, these parameters do not need to be specified.

Turning ON/OFF the FTP Passive Mode

Turn this function ON when using the DL1620/DL1640/DL1640L behind a firewall that requires the passive mode. The default setting is OFF.

(A firewall is furnished on a system that has security features. It prevents intrusion from the outside into the network system.)

Setting the LPR Timeout Time

The DL1620/DL1640/DL1640L closes the connection to the printer if there is no response from the printer for a certain period of time (timeout time) when it accesses the printer.

Select the value in the range of 0 to 3600 s. The default value is 15 s.

Setting the SMTP Timeout Time

When a mail server is accessed from the DL1620/DL1640/DL1640L and connection cannot be established after a certain period of time (timeout time), the DL1620/DL1640/DL1640L decides that the connection to the mail server is not possible and closes the connection.

Select the value in the range of 0 to 3600 s. The default value is 15 s.

13.11 Setting the Time Difference from the GMT (Greenwich Mean Time) and SNTP

Relevant Keys

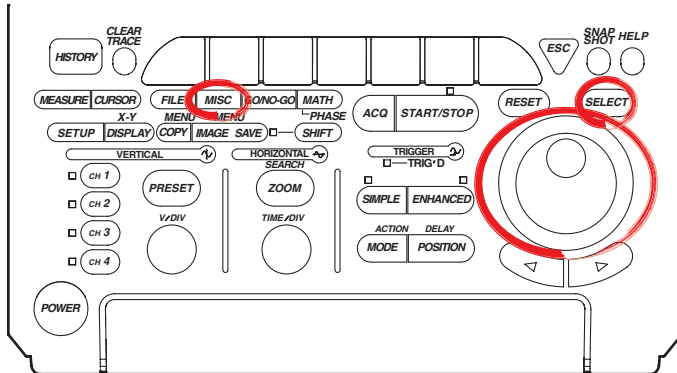

Procedure

1. Press **MISC**.
2. Press the Network soft key to display the Network menu.
3. Press the Others soft key to display the Others settings menu.

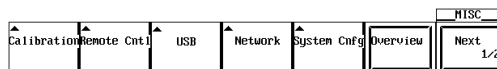

4. Turn the jog shuttle to select Time Hour for Time Difference From GMT.

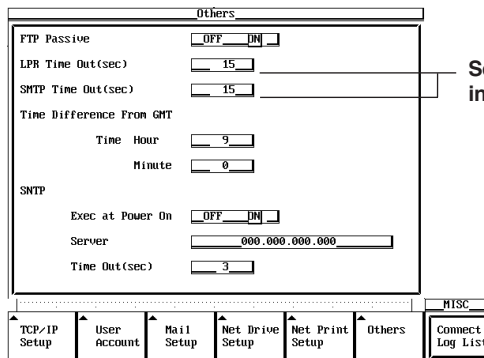

Settings for the following items can be input directly using a USB keyboard. (Ⓜ)

5. Press **SELECT** to display a dialog box where you can make time settings.
6. Turn the jog shuttle to set the number of hours in the range of -12 to 13.
7. Likewise, set the Minute of Time Difference From GMT in the range of 0 to 59.

Note

Minute can be specified only if Time Hour is set in the range of -11 to 12. (Minute cannot be specified if Time Hour is set to -12 or 13.)

Setting Up SNTP (Simple Network Time Protocol, Version 1.13 or Later)

8. Turn the jog shuttle to select Exec at Power On.
9. Select ON or OFF by pressing **SELECT**.
10. Turn the jog shuttle to select Server.
11. Press **SELECT** to display the keyboard.
12. Enter the IP address for the SNTP server.
13. Turn the jog shuttle to select Time out.
14. Press **SELECT** to display the time settings box.
15. Turn the jog shuttle to set the time out time in the range from 1-60.

Explanation

Set the time difference from the GMT (Greenwich Mean Time). Make sure that you set this value if you are using the Web server function.

Setting the Time Difference from the GMT (Greenwich Mean Time)

Set the time difference in the range of –12 hours 00 minute to 13 hours 00 minute.

For example, the Japanese standard time is ahead of the GMT by 9 hours. In this case, set Time Hour to 9 and Minute to 00.

Checking the Standard Time

Check the standard time for the region where the DL1620/DL1640/DL1640L is used with one of the following methods.

- Check the date and time settings of your computer.
- Check the Web site at <http://www.worldtimeserver.com/>

Note

The DL1620/DL1640/DL1640L does not support daylight saving time. To set the daylight saving time, adjust the time difference from the GMT.

SNTP Settings

When turning ON the power to the instrument, the instrument's time is synchronized with that of the SNTP server connected to the network.

Note

-
- If a time difference from world standard time (Greenwich Mean Time) is specified, the time obtained from the SNTP server is adjusted accordingly, and that time is used.
 - When setting the date and time on the instrument, you can synchronize the time with the SNTP server. For details, see section 3.6, "Setting the Date and Time."
 - When not synchronizing the time with the SNTP server, do not enter the SNTP server's IP address.
-

13.12 Using the Web Server Function

You can use the Web server function with the DL1620/DL1640/DL1640L to display the screen image of the DL1620/DL1640/DL1640L on the Web browser on your computer and perform file operations on the DL1620/DL1640/DL1640L using the keys displayed in your Web browser.

This section contains the following information.

- Overview of the Web Server Function -> See this page.
- Operating Environment
 - Computer Environment -> See page 13-28.
 - DL1620/DL1640/DL1640L Environment -> See page 13-29.
- Preparations for Using the Web Server Function
 - Preparations on the DL1620/DL1640/DL1640L -> See page 13-30.
 - Preparations on the Computer -> See page 13-31.
- Using the Web Server Function
 - Using the FTP Server Function -> See 13-35.
 - Capturing Data -> See page 13-36.
 - Displaying the Measurement Trend of Waveform Parameters -> See page 13-41.
 - Using Control Scripts -> See page 13-45.
 - Displaying the Log -> See page 13-47.
 - Displaying the DL1620/DL1640/DL1640L Information -> See page 13-49.
 - Viewing the Link Destination -> See page 13-50.

Overview of the Web Server Function

FTP server function (on the Web browser)

View the list of files stored on the storage media of the DL1620/DL1640/DL1640L (internal flash memory or built-in storage medium) and transfer files to your computer.

Data capture

The following operations are possible:

- Change the display format of the DL1620/DL1640/DL1640L and display data in the history memory.
- Display the screen image of the DL1620/DL1640/DL1640L.
- Save waveform and setup data on your computer.
- Load setup data saved on your computer to the DL1620/DL1640/DL1640L.

Measurement trend of waveform parameters

Using the Excel function, display the trend of the selected waveform parameters.

The statistical processing of measured values is also possible.

Control script

Control the DL1620/DL1640/DL1640L using communication commands. (Refer to the Communication Interface User's Manual IM701610-17E.)

Log

Displays the log of errors, GO/NO-GO determinations, and action-on-trigger events that occurred on the DL1620/DL1640/DL1640L. Up to the 30 newest incidents are logged.

DL1620/DL1640/DL1640L information

Displays the DL1620/DL1640/DL1640L model, the presence/absence of options, the ROM version (firmware version), etc.

Link

View the Web page of the DL1620/DL1640/DL1640L.

Operating Environment

Computer Environment

Computer

Computer running Microsoft Windows 98 Second Edition, Microsoft Windows NT 4.0, Microsoft Windows Millennium Edition, Microsoft Windows 2000 Professional, or Microsoft Windows XP Professional.

OS

Microsoft Windows 98 Second Edition, Microsoft Windows NT 4.0, Microsoft Windows Millennium Edition, Microsoft Windows 2000 Professional, or Microsoft Windows XP Professional.

Internal memory

64 MB or more recommended.

Communication port

Ethernet communication port that supports 10BASE-T or 100BASE-TX. Use this communication port to connect the computer to the network.

Display

Display supported by the OS indicated above with a minimum resolution of 1024 × 768 pixels or higher.

Mouse or pointing device

Mouse or pointing device supported by the OS indicated above.

Files required for the Web browser

The following files are required when using the Web Server function's data capture, measurement trend, or command script functions. For the installation procedure, see "Installing Files Required for the Web Browser" (page 13-32).

```
msvbvm60.dll
cmdlgjp.dll
comdlg32.ocx
```

Tested Combinations of OS and application software

OS	Web Browser	Spreadsheet Software*
Windows NT	Internet Explorer 5.0	Microsoft Excel 97
Windows 98	Internet Explorer 5.0	Microsoft Excel 97
Windows 98 Second Edition	Internet Explorer 5.0	Microsoft Excel 97
Windows 2000 Professional	Internet Explorer 5.0/5.5/6.0	Microsoft Excel 97
Windows Millennium Edition	Internet Explorer 5.5/6.0	Microsoft Excel 97/2000/2002
Windows XP Professional	Internet Explorer 6.0	Microsoft Excel 2002

* The spreadsheet software is required when displaying the trend of waveform parameters with the Web server function.

DL1620/DL1640/DL1640L Environment

Connection to the Network

Connect the DL1620/DL1640/DL1640L to the network using the Ethernet. For the connection procedure, see section 13.1.

TCP/IP

Configure the network environment and IP address for communication using the Ethernet interface. For the procedure, see section 13.2.

Communication interface

Set the communication interface to Network. For the procedure, see "Setting the Communication Interface to Network" (page 13-30).

User account

Set the user account used to access the DL1620/DL1640/DL1640L from the computer. For the procedure, see section 13.8.

Time difference from the Greenwich Mean Time

When using the Web server function, set the time difference from the GMT. Normally, the time difference is also set on the computer. Setting the time difference correctly allows the DL1620/DL1640/DL1640L and the computer to detect the local time correctly. Consequently, the computer is able to detect whether a file is new when transferring or saving the file. For the procedure, see section 13.11.

Note

- Use Internet Explorer version 5.0 or later as the Web browser.
- The Web server function contains software programs that have not been authenticated. Therefore, the following dialog box may appear. In such case, click **Yes** and install the software.

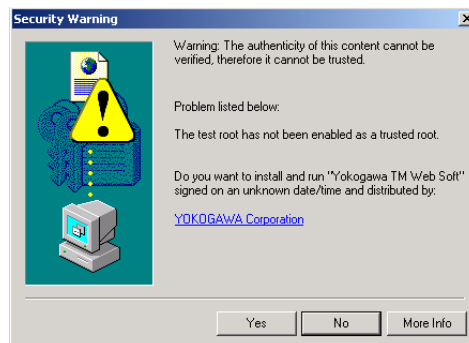

- You cannot open multiple Internet Explorer windows on the same computer and use the same function of the Web server function simultaneously.
 - When using the storage function of the FTP server function (on the Web browser), data capture function, or the log display on the same computer, other Web server functions cannot be used.
 - When using the storage function of the FTP server function (on the Web browser), data capture function, or the log display on a computer, other computers cannot use the Web server function.
 - The Web server function uses communicates through the Ethernet interface. If the Ethernet interface is configured to control the DL1620/DL1640/DL1640L using a communication command (refer to the Communication Interface User's Manual IM701610-17E), the Ethernet interface cannot be used simultaneously.
 - When the DL1620/DL1640/DL1640L is printing or operating on files (file operation from the front panel key or file transfer using the FTP server function), the Web server function cannot be used.
-

Preparations for Using the Web Server Function

Connecting the Computer and the DL1620/DL1640/DL1640L to the Network

Connect the computer and the DL1620/DL1640/DL1640L to the network. For the connection procedure, see section 13.1.

Preparations on the DL1620/DL1640/DL1640L

Setting the Communication Interface to Network

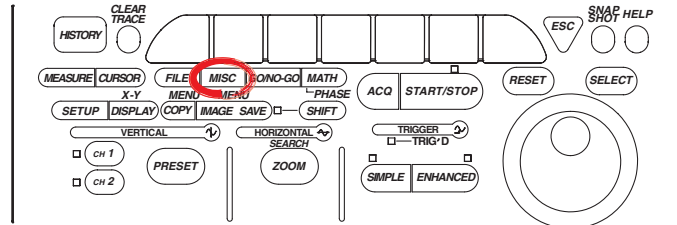

Turn ON the DL1620/DL1640/DL1640L. After it starts, perform the following procedure.

1. Press **MISC** to display the MISC menu.
2. Press the **Remote Cntl** soft key to display the Remote Cntl menu.

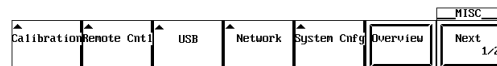

3. Press the **Device** soft key to display the Device menu.

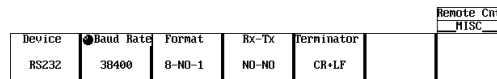

4. Press the **Network** soft key. The Ethernet interface is selected as the communication interface.

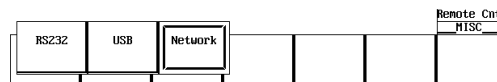

Setting up the TCP/IP

5. Set the TCP/IP on the computer and the DL1620/DL1640/DL1640L. For the procedure on the DL1620/DL1640/DL1640L, see section 13.2.

Setting the User Account Used to Access the DL1620/DL1640/DL1640L

6. Set the user account used to access the DL1620/DL1640/DL1640L from the computer. For the procedure, see section 13.8.

Setting the Time Difference from the GMT (Greenwich Mean Time)

7. Set the time difference between the DL1620/DL1640/DL1640L location and the GMT. For the procedure, see section 13.11.

Rebooting

8. To activate the TCP/IP, user account, and time difference settings, turn OFF the DL1620/DL1640/DL1640L. After a few seconds, turn ON the DL1620/DL1640/DL1640L again.

Preparations on the Computer

1. Start your computer and log on to the system.
If the computer is running Windows NT, Windows 2000, or Windows XP, log on as an administrator. If you do not log on as an administrator, you may not be able to install files that are required to use the Web server function (described later).

Logging on to the Web Server (DL1620/DL1640/DL1640L)

2. Start Internet Explorer.
3. Enter the IP address of the DL1620/DL1640/DL1640L (for example, 192.168.0.101) or the host name of the DL1620/DL1640/DL1640L (for example, dl1600-1) if a DNS server is available on the network, as shown below.

Enter the IP address **http://192.168.0.101/**

Enter the host name **http://DL1620/DL1640/DL1640L-1/**



4. Press the ENTER key on the keyboard. A network password input dialog box appears.
5. Enter the user name and password.
 - Enter the user account (see the previous page) used to access the DL1620/DL1640/DL1640L. In the example below, "DLUSER" and "*****" are entered as the user name and password, respectively.
 - If the user name of the user account is set to "anonymous" (default setting), the password is not required.
6. Click **OK**. If the logon to the DL1620/DL1640/DL1640L Web server is successful, the Web server window appears.

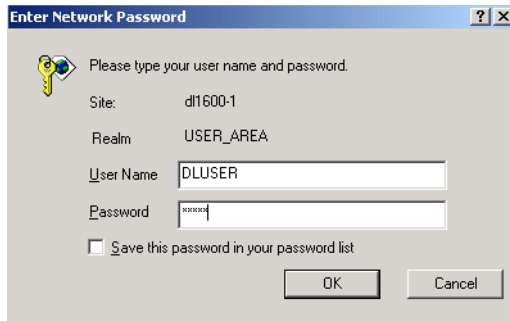

Web server window

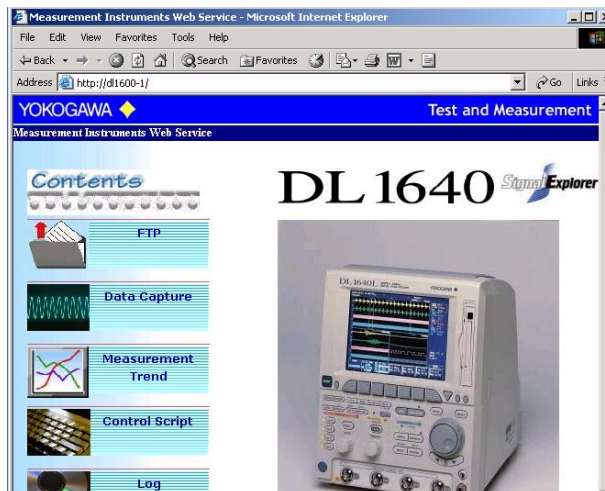

Installing Files Required for the Web Browser

- **Using the DL1620/DL1640/DL1640L and the Computer While Connected to the Internet**

When you use the Web server function for the first time, the files required for the Web browser are installed automatically from the Microsoft Web site.

* If `Msvbvm60.dll`, `cmdlgjp.dll`, and `comdlg32.ocx` are already installed on the computer when using the Web server function for the first time, step 7 is not required.

7. When the data capture, measurement trend, or command script function of the Web server function are used for the first time, three files (`Msvbvm60.dll`, `cmdlgjp.dll`, and `comdlg32.ocx`) are automatically downloaded from the Microsoft Web site and installed on the computer. At this point, a dialog box allowing you to confirm the installation appears. Click **Yes**. (You may need to restart your computer during the installation.)

After the installation is completed successfully, proceed to step 9.



OR

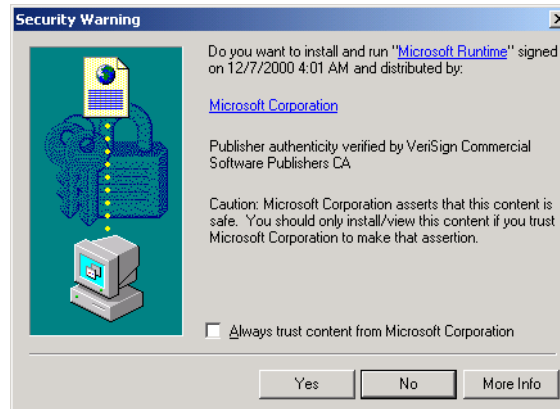

- **Using the DL1620/DL1640/DL1640L without Connecting to the Internet**

If `Msvbvm60.dll`, `cmdlgjp.dll` and `cmdlg32.ocx` are not installed on the computer when using the Web server function for the first time, install the files beforehand according to the following procedure.

7. Download the following file from the YOKOGAWA Web site (<http://www.yokogawa.com/tm/Bu/DLsoft/web.htm>).
YOKOGAWA T&M Web Runtime: ytmwrun.exe
Data size: Approx. 1.5 MB
8. Double-click the file that you downloaded above. The installation of the aforementioned three files starts. Follow the instructions on the screen to install the files.

Checking the Web Browser (Internet Explorer) Security Settings

Check Internet Explorer security settings. The settings indicated in the table on the next page are the default settings. If your browser security settings do not match those on the next page, adjust them accordingly. Otherwise, the Web server function cannot be used. The following explanation uses Internet Explorer 5.5. With other versions, perform the equivalent steps accordingly.

9. Click **Internet Options** on the **Tools** menu. The Internet Options dialog box appears.
10. Click the **Security** tab.
11. Select a Web content zone.
The Web content zone varies depending on your network environment and browser settings. Ask your network administrator to select the correct zone.

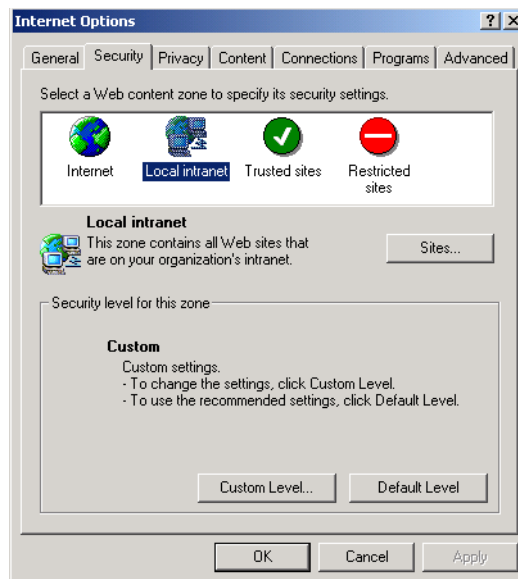

12. Click **Custom Level**. The Security Settings dialog box opens.

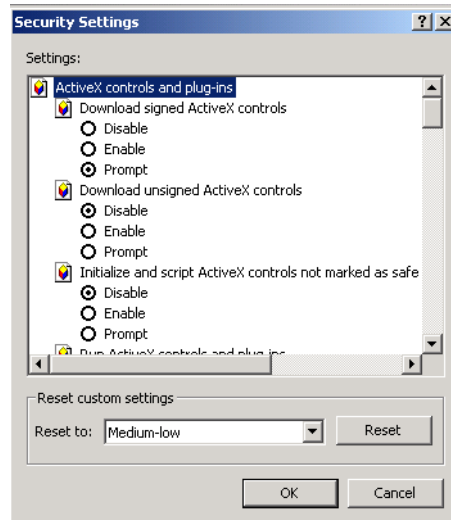

13. Adjust the security settings according to the following table.

Item	Security Level
Run ActiveX controls and plug-ins	Enable
Script ActiveX controls marked safe for scripting	Enable
Download signed ActiveX controls	Prompt

14. Click **OK**.

Using the Web Server Function

Using the FTP Server Function (with the Web Browser)

Before using this function, make sure that the communication interface of the DL1620/DL1640/DL1640L is set to Network (see page 13-30).

Click the **FTP** icon in the Web server window. A window used to view the storage media of the DL1620/DL1640/DL1640L (storage media view window) appears.

The storage media view window may not appear. In this case, click the Refresh button of the Web browser. A logon dialog box appears. Log on. The storage media view window appears.

Web server window

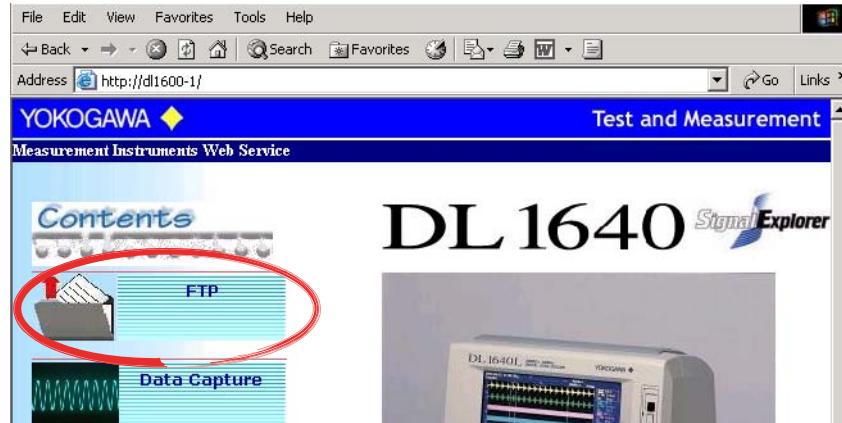

Storage media view window

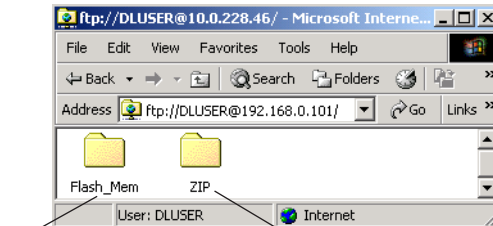

Internal flash memory

Built-in storage media

Depending on the product specifications, one of the following is displayed.

- Fd: Floppy disk
- Zip: Zip disk
- PC Card: PC card

- You can open folders on each storage medium and view the file list.
- You can select files displayed in the window and transfer files to the computer.

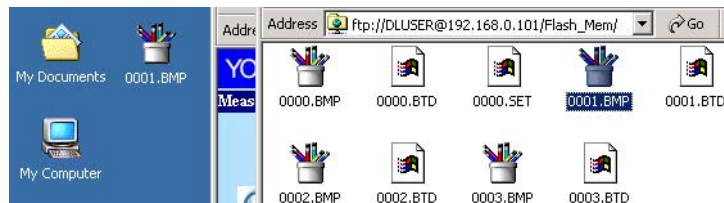

Note

- Up to two computers can be logged on to the file transfer function simultaneously.
- You cannot operate the files simultaneously from two computers.
- When the DL1620/DL1640/DL1640L is printing or operating on files (file operation from the front panel key or file transfer using the FTP server function), the Web server function cannot be used.

Capturing Data

Before using this function, make sure that the communication interface of the DL1620/DL1640/DL1640L is set to Network (see page 13-30).

Click the **Data Capture** icon in the Web server window. The Data Capture window appears. It displays the screen image of the DL1620/DL1640/DL1640L and the control panel that allows you to save and load data.

Web server window

Update indicator

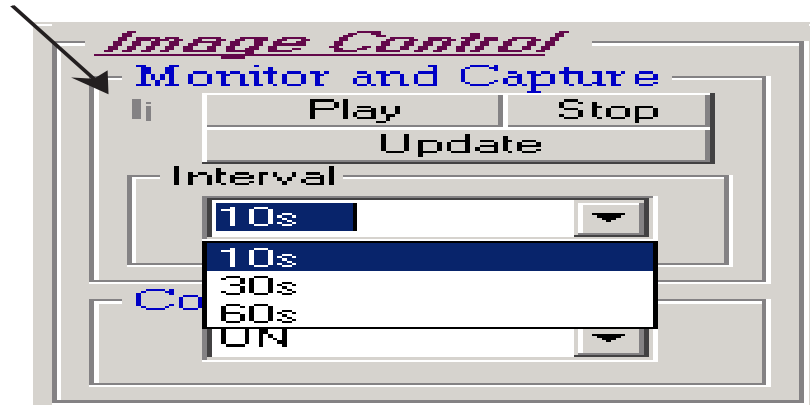

Data Capture window

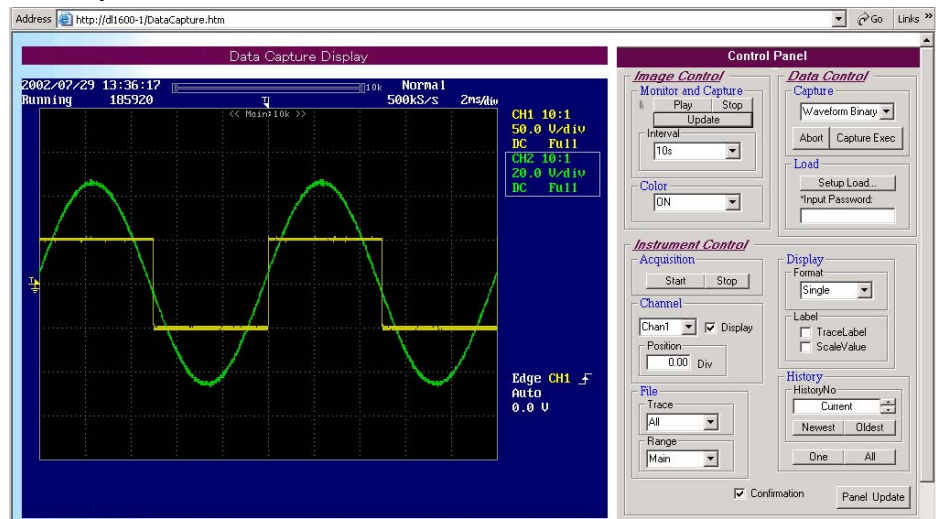

↑ DL1640/DL1640L screen image

↑ Control panel

Displaying and Saving the Screen Image (Image Control)

The screen image of the DL1620/DL1640/DL1640L can be displayed on the computer screen and then saved.

- **Updating the Screen Image (Monitor & Capture)**

Play

Click **Play**. The update indicator becomes green and the screen image begins being updated at then specified display update interval (see below).

Stop

Click **Stop** to turn off the update indicator and stop the screen image updating.

Update

The screen image is updated when you click **Update**.

Interval

Set the display update **Interval** to 10 s, 30 s, or 60 s.

Update indicator

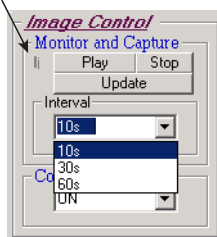

- **Selecting the Display Color of the Screen Image (Color)**

Select the display **Color** from **ON**, **OFF**, **Reverse**, and **Gray**. For a description of the information displayed with each setting, see the explanation in section 10.4.

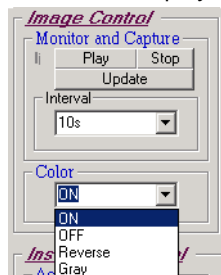

Note

The time it takes to display the screen image on the computer screen varies depending on the color setting. In descending order of time, the color settings are ON, Reverse, Gray, and OFF.

- **Saving the Screen Image on the Computer**

Right-click the screen image. A shortcut menu appears as shown in the following figure. Click **Save Picture As** to save the current screen image.

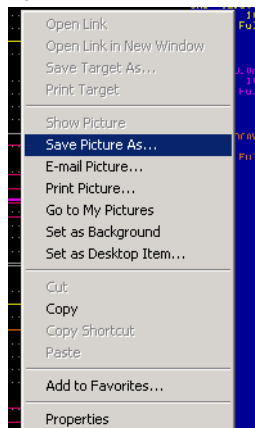

Saving Data on the Computer and Loading Setup Data from the Computer to the DL1620/DL1640/DL1640L (Data Control)

- **Saving Data on the Computer (Capture)**

Data type

Select the type of data to be saved from **Waveform Binary**, **Waveform ASCII**, **Waveform Float**, **Setup**, and **Measure**. For details on the settings, see sections 11.6, 11.7, and 11.9.

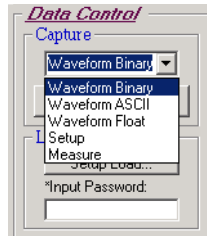

Capture Exec

In the dialog box that appears when you click **Capture Exec**, set the save destination and file name, and save the data.

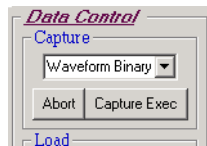

Abort

To abort the save operation while data is being saved, click **Cancel** in the dialog box. Then, click **Abort** on the control panel.

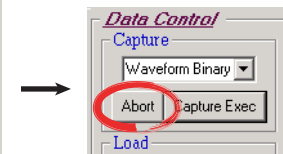
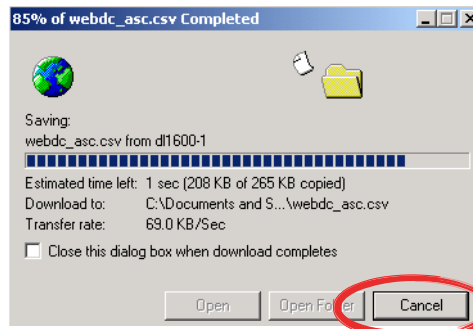

You must enter a password to abort. For details, see "Input Password" in the next section.

- **Loading the Setup Data from the Computer to the DL1620/DL1640/DL1640L (Load)**

Input Password

Enter the password (see page 13-31) that you used to log on to the Web server (DL1620/DL1640/DL1640L). If the user name of the user account is set to "anonymous" (default setting), the password is not required.

Setup Load

Click **Setup Load** to display the Open dialog box. Select the setup data file that you want to load and click **OK** to load the file.

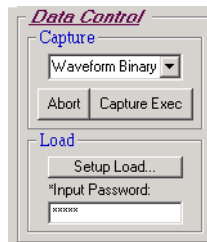

Note

- Depending on the operating condition of the DL1620/DL1640/DL1640L (such as when measurements are in progress), it may not be possible to save data or load setup data.
- When data is being saved or the setup data is being loaded, other Web server functions cannot be used.
- When loading setup data or aborting a save operation, a temporary file (zzzftpzzztmpzzz.bat) is created in the Internet Explorer startup folder. When the operation is complete, the temporary file is deleted.
- If you try to save data when there is no waveform data or waveform parameter, an error appears on the DL1620/DL1640/DL1640L screen, and a 0-byte file is saved.

Controlling the DL1620/DL1640/DL1640L (Instrument Control)

You can use the computer to set the display format and the data save conditions of the DL1620/DL1640/DL1640L. The settings made here apply to the display format and save conditions used to save the data described on the previous page.

- **Starting/Stopping Waveform Acquisition (Acquisition)**

Start: Click **Start** to start waveform acquisition.

Stop: Click **Stop** to stop waveform acquisition.

- **Turning the Waveform Display ON or OFF, and Setting the Vertical Position (Channel)**

Selecting the Target Waveform

In the **Channel** group box, select the channel that you want to display or not, and for which you want to set the vertical position from the following:

Chan1 to Chan4 (or Chan1 to Chan2 (channels1 to 2) for the DL1620) (channels 1 to 4)

Display ON or OFF

To display the waveform of the selected channel (turn it ON), select the **Display** check box. Clear the check box not to display the waveform of the selected channel (turn it OFF).

Vertical Position

You can set the vertical position of the waveform of the selected channel. For a description of the vertical position selectable range, see section 5.2.

- **Setting the Display Format (Display)**

Display Format

Select the number of divisions on the screen when displaying waveforms from the following:

Single, Dual, or Quad.

For the meaning of the selections, see the explanations in section 8.1.

Turning the Display of the Waveform Labels and Scale Values (Label) ON or OFF

- Display Waveform Label (TraceLabel)

To display the labels of the displayed waveforms, select the **TraceLabel** check box. Clear the check box not to display the labels.

- Turning the Display of the Upper and Lower Limits of the Displayed Waveforms (ScaleValue) ON or OFF

To display the upper and lower limits of the displayed waveforms, select the **ScaleValue** check box. Clear the check box not to display the upper and lower limits.

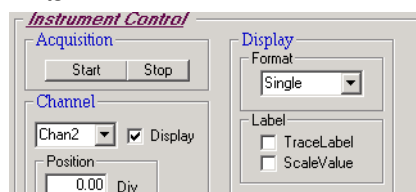

- **Selecting the Waveforms to Be Saved (File)**

- **Selecting the Target Waveforms (Trace)**

From the **Trace** list, select the waveforms to be saved from the following:

All (all waveforms), 1 to 4 (or 1 to 2 (channels 1 to 2) for the DL1620) (channels 1 to 4), or Math 1 to Math 2 (or Math 1 only for the DL1620) (computed waveforms).

- **Selecting the Range to be Saved (Range)**

Select the range in which the displayed target waveforms are to be saved from the following:

Main, Z1, Z2, and Z1_Z2 (displayed as Z1&Z2 on the DL1620/DL1640/DL1640L's menu.)

For the meaning of the selections, see the explanations in section 11.6.

- **Setting the History Data Display**

- **Selecting by History Data Number (History No.)**

You can specify the history number of the data to be displayed.

- **Selecting the Newest or Oldest Data**

You can specify the newest or the oldest data in the history data to be displayed.

- **Selecting One or All**

- One
Click **One** to display a single history data point that is selected by the data number or selected by newest or oldest.
- All
Click **All** to display all history data.

- **Updating the Settings (Panel Update)**

Click **Panel Update** to update the control panel settings on the Data Capture window (computer) to match the latest setting of the DL1620/DL1640/DL1640L.

- **Automatically Updating the Screen Image (Confirmation)**

Select the **Confirmation** check box to automatically update the screen image using the same conditions as Color-OFF when you change settings above that can change the screen image. Clear the check box not to update automatically.

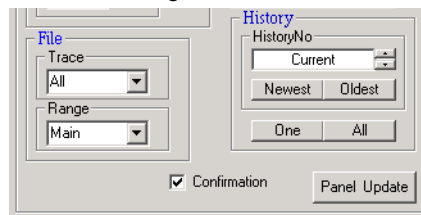

Note

- You cannot set the history data display when the DL1620/DL1640/DL1640L is making measurements.
- Setting the history data display when there is no history data results in an error.
- When controlling the DL1620/DL1640/DL1640L, the timeout time on the computer is 30 s. Depending on the condition of the DL1620/DL1640/DL1640L, a timeout may occur preventing you from controlling the DL1620/DL1640/DL1640L.

Displaying the Measurement Trend of Waveform Parameters

Before using this function, make sure that the communication interface of the DL1620/DL1640/DL1640L is set to Network (see page 13-30).

Click the **Measurement Trend** icon in the Web server window. The Measurement Trend window where the trend display of waveform parameters can be set appears.

Web server window



DL 1640 *Signal Explorer*

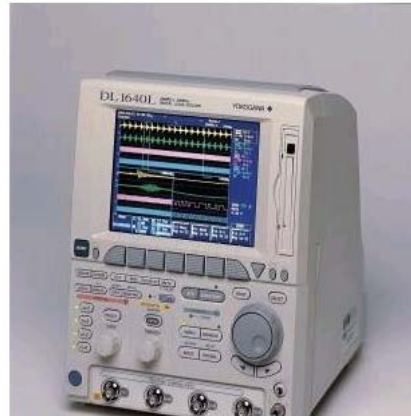

Measurement Trend window

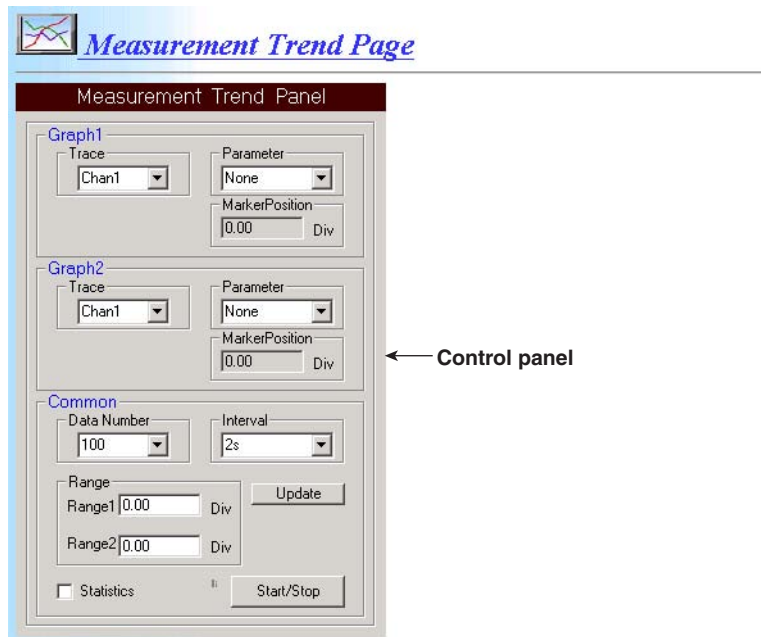

Note

- This function retrieves the selected waveform parameters at the selected interval from the DL1620/DL1640/DL1640L to the computer and displays the trend. To display the retrieved measurement values and trend, Microsoft Excel 97 or later must be installed on the computer.
- If the measurement value of a waveform parameter is not a normal number (Not A Number), the cell displaying the measurement value in Microsoft Excel is blank.

Setting the Trend Display Conditions

- **Selecting the Waveform Parameter to Be Displayed (Graph 1 and Graph 2)**

You can display two trend graphs. For each graph, you can specify the trend target waveform and the waveform parameter. When the waveform parameter is "Marker," you can set Marker Position.

- **Selecting the Target Waveform (Trace)**

From the **Trace** list, select the target waveform for the trend display from the following:

Chan1 to Chan4 (or Chan1 to Chan2 (channels 1 to 2) for the DL1620) (channels 1 to 4), Math1 to Math2 (or Math1 only for the DL1620) (computed waveforms)

- **Selecting the Waveform Parameter**

From the **Parameter** list, select the target waveform parameter for the trend display (same expression as the communication command) from the following. For the meaning of the waveform parameters and the marker cursors, see the explanations in sections 9.1 or 9.2.

Parameter DL1620/DL1640/DL1640L Menu	DL1620/DL1640/DL1640L Menu	Parameter	DL1620/ DL1640/DL1640L Menu
None	Not selected	NOVERSHOOT	-OShot
AVERAGE	Avg	NWIDTH	-Width
AVGFREQ	AvgFreq	PERIOD	Period
AVGPERIOD	AvgPriod	PNUMBER	Pulse
BWIDTH1	Burst1	POVERSHOOT	+OShot
BWIDTH2	Burst2	PTOPEAK	P-P
DELAY (For a detailed setting, use Delay Setup on the DL1620/DL1640/DL1640L)	Delay	–	–
DUTYCYCLE	Duty	PWIDTH	+Width
FALL	Fall	RISE	Rise
FREQUENCY	Freq	RMS	Rms
HIGH	High	SDEVIATION	Sdev
LOW	Low	TY1INTEG	Int1TY
MAXIMUM	Max	TY2INTEG	Int2TY
Marker(M1<2>) (marker cursor for cursor measurements)	M1<2>	XY1INTEG	Int1XY
MINIMUM	Min	XY2INTEG	Int2XY

- **Setting the Marker Position**

You can set the marker position if Marker(M1) or Marker(M2) is selected as the waveform parameter.

- **Setting the Conditions for Retrieving the Measurement Values of Waveform Parameters (Common)**

- **Number of Displayed Measurement Values (Data Number)**

Select the number of measurement values (measurement values retrieved from the DL1620/DL1640/DL1640L to the computer) to be displayed in Excel from the following. If the number of measurement values exceeds the selected number, the values are cleared from the oldest values to display the newest measurement values.

10, 20, 50, 100, 200, and 500

- **Retrieve Interval**

Select the retrieve interval from the following. However, of the selected waveform parameters, select the interval to match the longest parameter cycle measured on the DL1620/DL1640/DL1640L.

2 s, 5 s, 10 s, 30 s, and 60 s

Measurement Range

You can set the range on the time axis to measure the waveform parameter.

Range1 and Range2 are the start and end points, respectively.

Selectable range: ± 5 div

Resolution: Varies depending on the record length.

However, the measurement start point cannot be set to the same point as the measurement end point or to a value to the right of the measurement end point.

Turning the Statistics Display ON or OFF

- The statistics (Max, Min, and Average) of the waveform parameters retrieved to the computer can be displayed.
- To display the statistics, select the **Statistics** check box. Clear the check box not to display the statistics.
- The number of measurement values displayed in Excel is up to the number specified in Number of Displayed Measurement Values (Data Number) on the previous page. The statistics are determined on all the measured data since the trend display was started, not only on the displayed measurement values.

Updating the Settings

Click **Update** to update the Marker Position and Range that are set on the control panel of the Measurement Trend window to match the latest settings of the DL1620/DL1640/DL1640L.

Starting/Stopping the Trend Display of Waveform Parameter Measurement Values

• Start

Click **Start/Stop**. The indicator becomes yellow and the retrieval of the measurement values of waveform parameters starts at the specified retrieve interval. At the same time, Microsoft Excel starts and the measurement values and trend graphs are displayed/drawn. If the statistical display is ON, the statistics are also displayed. The retrieval of the measurement values of waveform parameters continues until the operation is stopped.

• Stop

- Click **Start/Stop** while the trend display is in progress. The indicator goes OFF, and the display and drawing of the measurement values and trend graph stop.
- If you attempt to save the data to a file or close Excel while the trend display is in progress, a runtime error occurs. In this case, select **No** on the runtime error dialog box and close the dialog box. Then, click Start/Stop in the Measurement Trend window to stop the trend display. After stopping the trend display, save the file or close Excel.

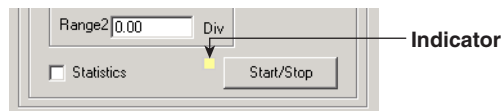

Display Example of Measurement Values, Trend Graphs, and Statistics

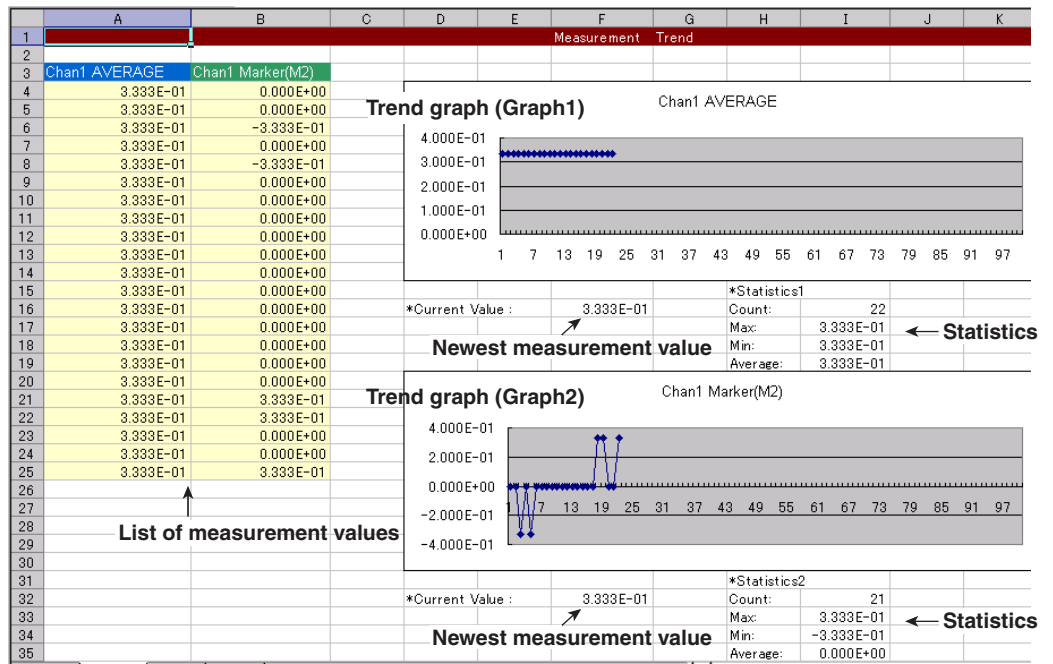

Using Control Scripts

Before using this function, make sure that the communication interface of the DL1620/DL1640/DL1640L is set to Network (see page 13-30).

Click the **Control Script** icon in the Web server window. The Control Script window used to send communication commands (see the Communication Interface User's Manual IM701610-17E) to the DL1620/DL1640/DL1640L and display the responses from the DL1620/DL1640/DL1640L appears.

Web server window



Control Script window

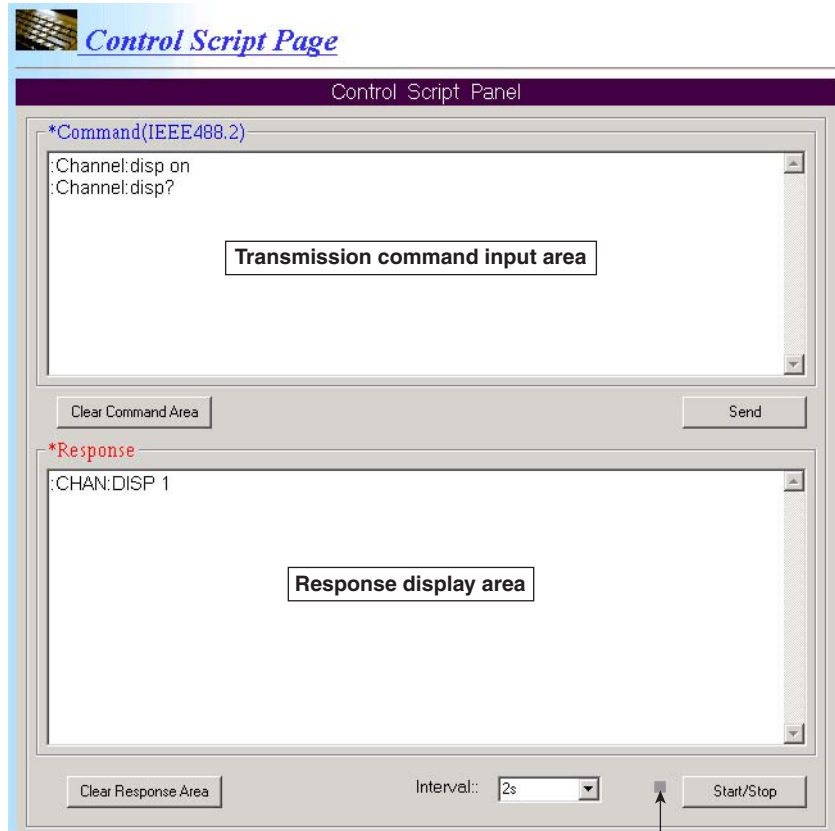

Indicator

Sending Commands (*Command IEEE 488.2)

- **Entering Transmission Commands**

Enter commands in the transmission command input area.
Maximum number of input characters: Up to 50,000 (50 KB).

- **Sending Commands**

Click **Send** to send commands in the transmission command input area collectively in the display order of the area.

- **Clearing the Entered Commands (Clear Command Area)**

Click **Clear Command Area** to clear all the commands in the transmission command input area.

Displaying the Responses from the DL1620/DL1640/DL1640L (*Response)

The responses from the DL1620/DL1640/DL1640L to the commands (queries) sent to it using the control script function can be received and displayed.

- **Clearing the Responses (Clear Response Area)**

Click **Clear Response Area** to clear all the responses received from the DL1620/DL1640/DL1640L that are displayed in the response display area.

Sending Commands Periodically and Displaying Responses

The commands in the transmission command input area can be sent periodically. If commands (queries) that require responses from the DL1620/DL1640/DL1640L are sent, the responses from the DL1620/DL1640/DL1640L are displayed in the response display area.

- **Setting the Transmission Interval**

Select the command transmission interval from the following:
2 s, 5 s, 10 s, 30 s, and 60 s

- **Starting Periodic Transmission (Start)**

Click **Start/Stop**. The indicator becomes in yellow, and the command transmission and response display start at the specified transmission interval.

- **Stopping Periodic Transmission (Stop)**

Click **Start/Stop** while the periodic transmission is in progress. The indicator goes OFF, and the command transmission and response reception/display stop. However, if the last command before stopping the periodic transmission was a query command, the response to that command is displayed in the response display area.

Note

- If a wrong command is sent, the error message is not automatically displayed in the Control Script window. The error code and message are displayed by entering the “:status:error?” command in the transmission command input area and sending the command. You can also confirm the error on the screen image displayed using the data capture function and also on the DL1620/DL1640/DL1640L screen.
- Binary data cannot be received or displayed.
- The transmission timeout is 30 s. Transmission and reception exceeding 30 s results in a timeout error. If all the commands specified in the transmission command entry area is sent, and the responses to the commands are not received within 30 s, a timeout error occurs.

Displaying the Log

Before using this function, make sure that the communication interface of the DL1620/DL1640/DL1640L is set to Network (see page 13-30).

Click the **Log** icon in the Web server window. The Log window displaying the log of errors, GO/NO-GO determination, and action-on-trigger events that occurred on the DL1620/DL1640/DL1640L appears. Up to the 30 newest events are logged. Events older than those do not appear in the log.

Web server window

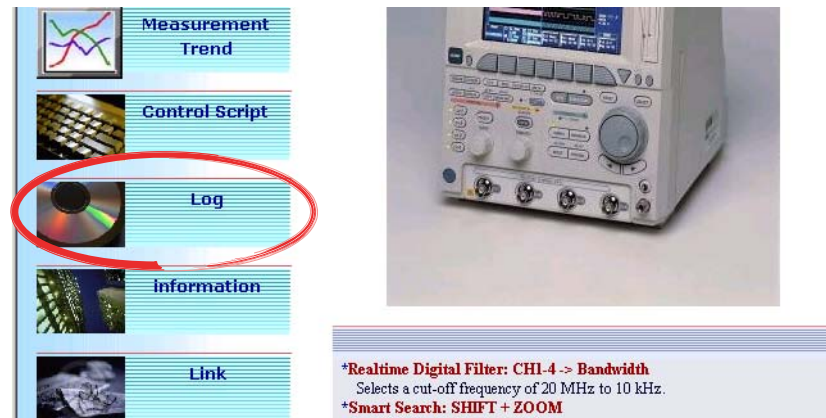

Log window

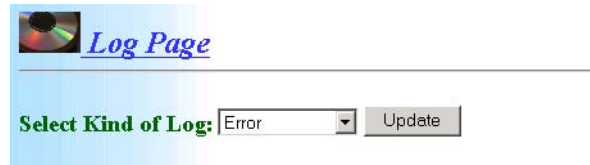

Displaying the Log

- **Selecting the Log Type (Select Kind of Log)**

From the list, select the log item to be displayed from the following:

 - **Error** (log of errors that occurred on the DL1620/DL1640/DL1640L)
 - **Go/Nogo** (log of GO/NO-GO determinations)
For the setup procedure of the GO/NO-GO determination, see sections 9.9 and 9.10.
 - **Action Trigger** (log of action-on-trigger events)
For the setup procedure of action-on-trigger events, see section 6.15.
- **Updating the Log (Update)**

Click **Update** to display the selected log. If the selected type of log is the same as that of the log being displayed, the log is updated.

Log Display Example

The following figure shows an example of GO/NO-GO determination log.

Displays Executing... while GO/NO-GO determination or action-on-trigger is in progress.

No.	Date	Time	Factor	Action
3	2002/07/29	14:34:31.30	trigger	Buzzer,File: /ZP0/0010.WVF ,Image: /ZP0/0006.TIF ,Mailto:
2	2002/07/29	14:34:23.48	trigger	Buzzer,File: /ZP0/0009.WVF ,Image: /ZP0/0005.TIF ,Mailto:
1	2002/07/29	14:34:14.18	trigger	Buzzer,File: /ZP0/0008.WVF ,Image: /ZP0/0004.TIF ,Mailto:

If screen image data or waveform data files are saved in the GO/NO-GO determination or action-on-trigger, the files can be saved on the computer from the log display.

Drives are displayed as follows in the GO/NO-GO determination log.

- RD0: Internal flash memory
 - FD0: Floppy disk
 - ZP0: ZIP disk
 - CA0: PC card
 - ND0: Network drive (when the Ethernet interface option is installed)
 - US□-□: USB storage
- └── Partition number (or LUN (Logical Unit Number))
 └── Address number

Note

- When the DL1620/DL1640/DL1640L is printing or operating on files (file operation from the front panel key or file transfer using the FTP server function), files cannot be saved on the computer. In addition, other Web server functions cannot be used while saving files.
- Files on the network drive (NetWork) cannot be saved to the computer.

Displaying the DL1620/DL1640/DL1640L Information

Before using this function, make sure that the communication interface of the DL1620/DL1640/DL1640L is set to Network (see page 13-30).

Click the **Information** icon in the Web server window. The Information window displaying the DL1620/DL1640/DL1640L model (Model), the maximum available record length (Record Length), the storage media type (Media), the presence of options (Option), the ROM version (firmware version, Soft Version), and other information appears.

Web server window

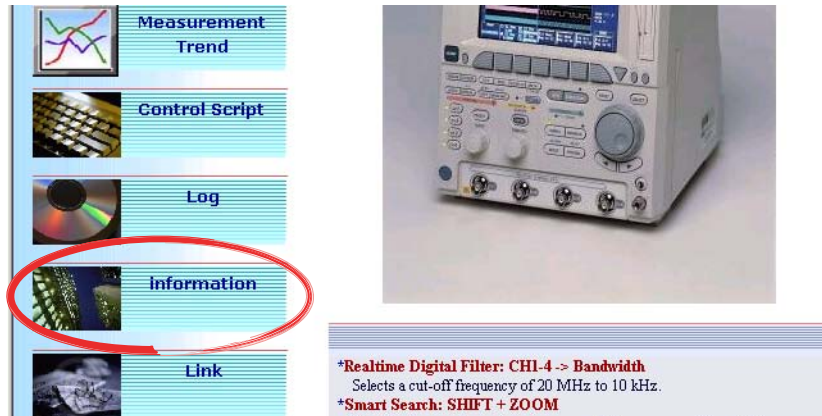

Information window

Information Page

System Overview

Item	Contents
Model	701610 -AC
RecordLength	Max8MW/CH
Media	ZIP(-J2)
Option	Printer:Yes
	GPIO:No
	Ether:Yes(MAC>000064_830_001)
	USB(H):Yes
	USB(F):Yes
	Others:No
Soft Version	1.01

Viewing the Link Destination

Before using this function, make sure that the communication interface of the DL1620/DL1640/DL1640L is set to Network (see page 13-30).

Click the **Link** icon in the Web server window. You can view the Web page of the DL1620/DL1640/DL1640L.

Web server window

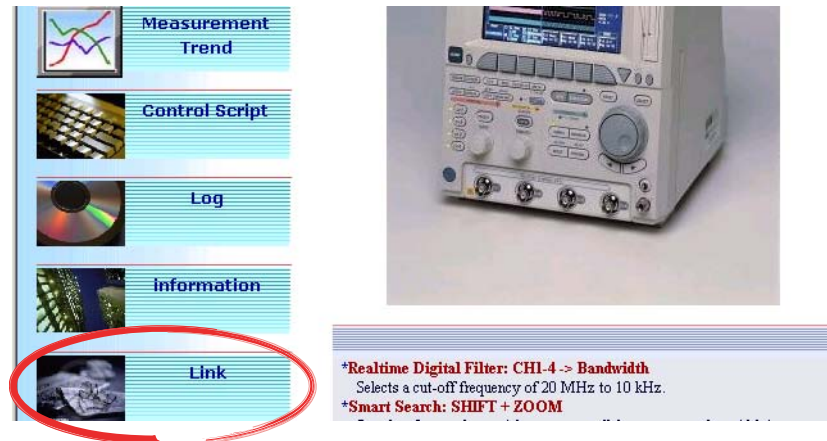

***Realtime Digital Filter: CH1-4 -> Bandwidth**
Selects a cut-off frequency of 20 MHz to 10 kHz.

***Smart Search: SHIFT + ZOOM**

Web Page Example (English Web Page)

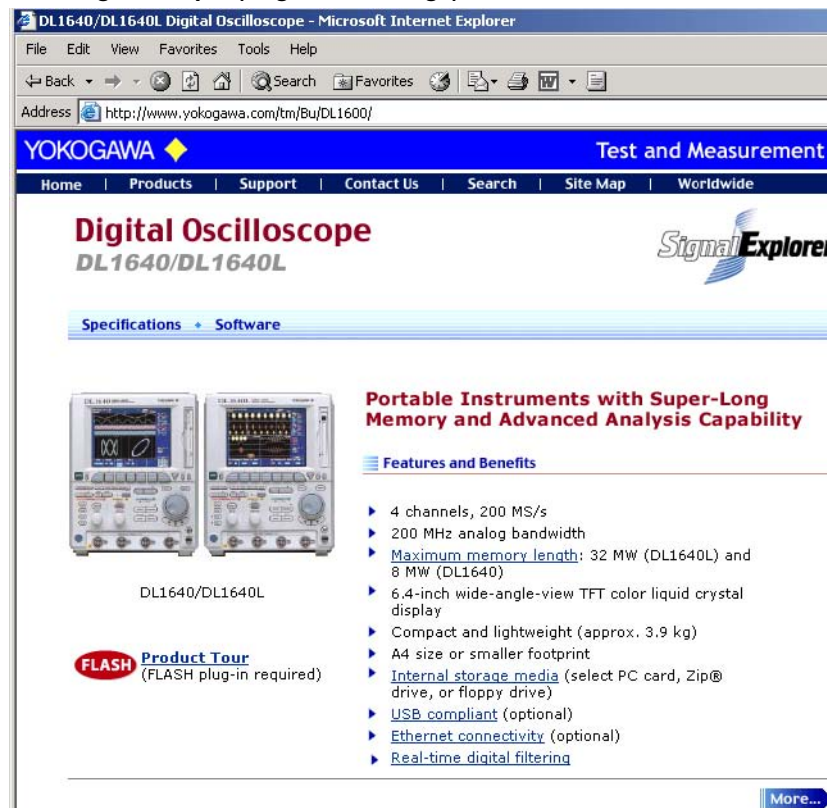

DL1640/DL1640L Digital Oscilloscope

Specifications + Software

DL1640/DL1640L

FLASH Product Tour
(FLASH plug-in required)

Portable Instruments with Super-Long Memory and Advanced Analysis Capability

Features and Benefits

- ▶ 4 channels, 200 MS/s
- ▶ 200 MHz analog bandwidth
- ▶ Maximum memory length: 32 MW (DL1640L) and 8 MW (DL1640)
- ▶ 6.4-inch wide-angle-view TFT color liquid crystal display
- ▶ Compact and lightweight (approx. 3.9 kg)
- ▶ A4 size or smaller footprint
- ▶ Internal storage media (select PC card, Zip® drive, or floppy drive)
- ▶ USB compliant (optional)
- ▶ Ethernet connectivity (optional)
- ▶ Real-time digital filtering

[More...](#)

Note

- To use the link function, the computer must be connected to the Internet.
- If the message language of the DL1620/DL1640/DL1640L is set to English, the English Web page is displayed; if the message language is set to Japanese, the Japanese Web page is displayed. For the setup procedure of the message language, see section 14.2.

13.13 Using the Instrument as a Windows Network Drive (Version 1.13 or Later)

You can set up the internal memory or external storage medium of the DL1620/DL1640/DL1640L as a network drive accessible from a PC running Windows XP.

Operating Procedure

Setting Up the DL1620/DL1640/DL1640L

Follow the procedures in section 13.2, "Configuring the Ethernet Interface (TCP/IP)," and section 13.8 "Accessing DL1620/DL1640/DL1640L Drives from a Network Drive (FTP Server Function)" to enter TCP/IP and user account settings, then connect to the network.

PC Settings

1. Open My Network Places.
2. Choose Map Network Drive under Tools on the menu bar. The Map Network Drive dialog box appears.

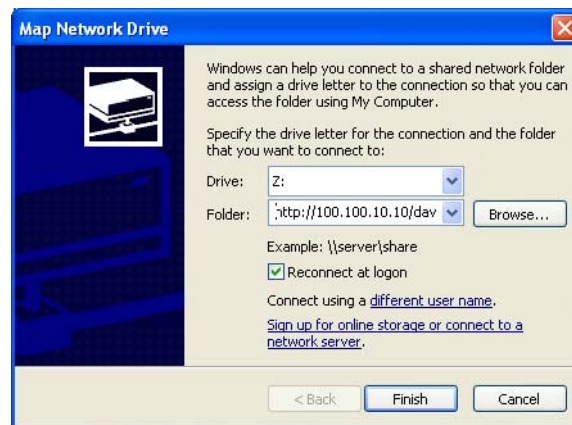

3. Select the drive to assign in the drive selection area.
4. Enter the instrument's IP address in the folder input area using the format, http://instrument's IP address/dav/.
5. The enter user name and password input dialog box appears. Enter the user name and password specified under user account (see section 13.8, "Accessing DL1620/DL1640/DL1640L drives from a network drive.")
6. Click Finish. The instrument is registered as a network drive.
7. To cancel the registration as a network drive, select Disconnect Network Drive under Tools on the menu bar. The disconnect network drive dialog box opens.
8. Select the network drive you wish to disconnect, and click OK.

Explanation

Network Drive

When the instrument is registered as a network drive, the DL1620/DL1640/DL1640L can be selected as a save destination using a software application running on a PC.

Note

Only Windows XP can register network drives.

Available Characters

This function uses the Windows WebDAV client function and the instrument's WebDAV server function. The characters that can be used with the WebDAV server function on this instrument are as follows.

Upper and lowercase English letters, space, numbers and:

! " # \$ % & ' () + , - . = @ [] ^ _ ` { } ~

Therefore, please make note of the following.

- Files and folders whose names contain characters other than the ones indicated above cannot be saved on the instrument's drive. Also, these files cannot be copied or moved.
- When using the Japanese version of Windows XP, a new folder cannot be created on the instrument's drive because the default name for newly created folders contains Japanese characters.
- Files in the instrument's drive containing characters other than those listed above are not displayed in the file list using WebDAV.

Also, these files and folders are not taken into account in the calculation of used disk space. Therefore, the actual amount of used disk space is different from the calculated amount of space.

File Information

If you copy files or folders from the instrument's drive to a Windows local disk, the creation date and time of the file or folder changes to that of the date and time copied. Likewise if you copy files or folders from a Windows local disk to the instrument's drive, the creation and modified dates and times of the file or folder changes to that of the date and time when copied.

14.1 Setting the Screen Color and Brightness

Relevant Keys

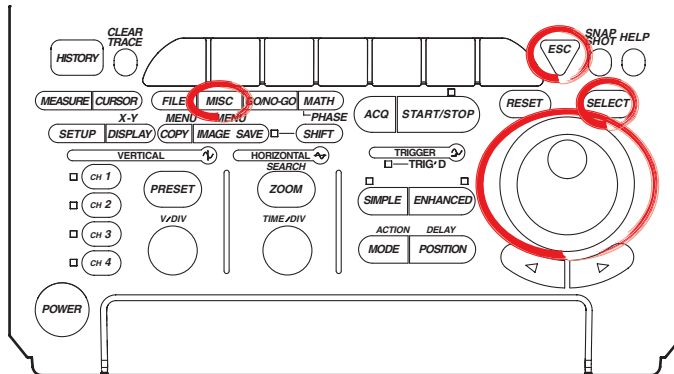

Operating Procedure

1. Press **MISC**.
2. Press the **Next 1/2** soft key.

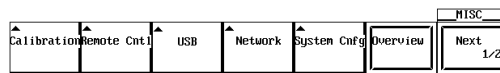

3. Pressing the **Graphic Color** soft key displays a menu used to set the display color and brightness.

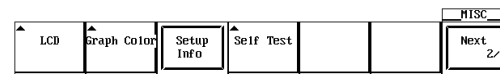

4. Pressing the **Mode** soft key displays a menu used to select the settings.

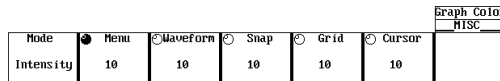

Setting the Color

5. Pressing the **RGB** soft key displays the display color setting menu.

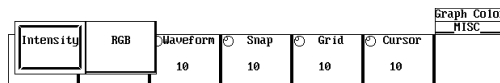

6. Pressing the **Menu** soft key displays a dialog box used to set the display color of the menu items.

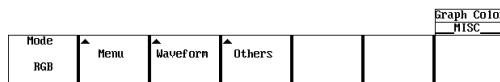

14.1 Setting the Screen Color and Brightness

- Turn the jog shuttle to move the cursor to the desired item.

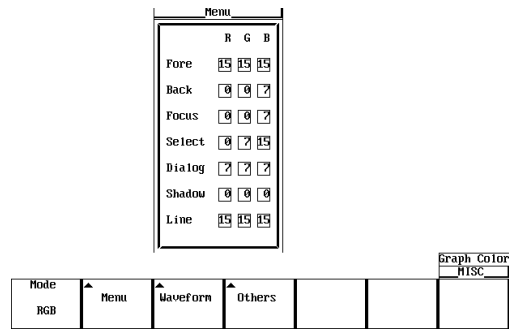

- Pressing **SELECT** displays the color setting menu.
- Turn the jog shuttle to set the color.
- Pressing **SELECT** closes the color setting menu.
- Pressing **ESC** closes the dialog box used to set the display color of the menu items.
- In a similar fashion, set the colors for the Waveform and Others items.

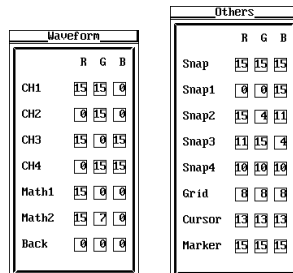

Setting the Brightness

- Pressing the **Intensity** soft key displays the brightness setting menu.

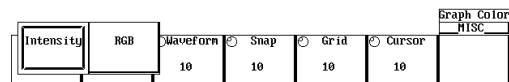

- Press the **Menu** soft key.

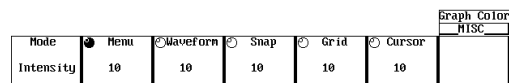

- Turn the jog shuttle to set the brightness of the menu screen.
- In a similar fashion, set the brightness for Waveform, Snap, Grid, and Cursor items.

Explanation**Screen Color**

You can set arbitrary colors for the following items. The colors are set using R (red), G (green), and B (blue) ratios from 0 to 15.

Menu Screen

Fore:	Selected menu item
Back:	Background
Focus:	Selected cursor
Select :	Selected menu
Dialog:	Dialog box
Shadow:	Background color of the selected menu
Line:	Lines on the menu screen

Waveform

CH1 to CH4:	Waveform color (or CH1 to CH2 for the DL1620)
Back:	Background color of the waveform display area

Others

Snap:	Snapshot waveform
Snap1 to 4:	Loaded snapshot waveforms
Grid:	Grid
Cursor:	Cursor
Marker:	Marker

Brightness

You can set the brightness for the following items from 1 to 15 steps.

Menu:	Menu screen
Waveform:	Waveform
Snap:	Snapshot waveform
Grid:	Grid
Cursor:	Cursor

14.2 Changing the Menu/Message Language and Click Sound

Relevant Keys

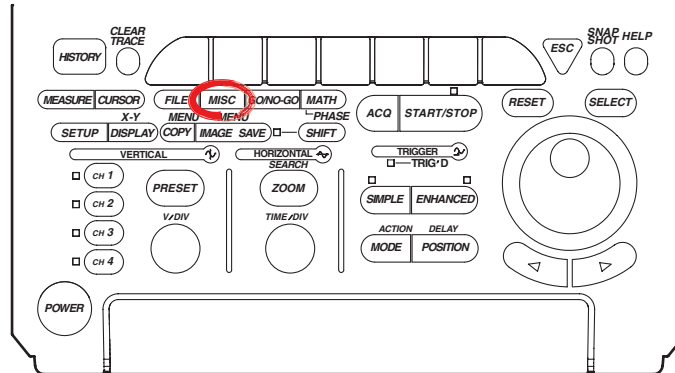

Operating Procedure

1. Press **MISC**.
2. Pressing the **System Cnfg** soft key displays the system configuration menu.

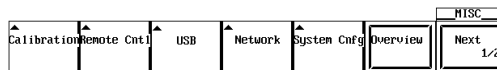

Setting the Menu Language

3. Press the **Menu Language** soft key to display the menu language selection menu.

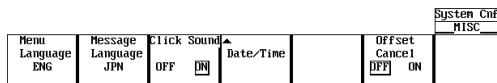

4. Press the **ENG**, **CHN**, or **KOR** soft key to select a menu language.

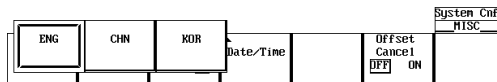

Setting the Message Language

3. Press the **Message Language** soft key to display the message language selection menu.

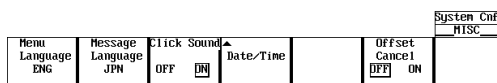

4. Press the **JPN**, **ENG**, **CHN**, or **KOR** soft key to select a message language.

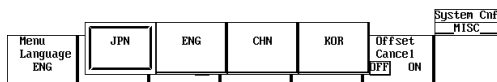

Note

The combinations of menu and message languages that can be set are as shown in the table below.

		Menu Language		
		English	Chinese	Korean
Message Language	Japanese	✓	-	-
	English	✓	✓	✓
	Chinese	✓	✓	-
	Korean	✓	-	✓

If Japanese*, Chinese, or Korean are set as either the menu language or message language option, then only that same language or English can be specified for the remaining option.

For example, if Chinese is set as the menu language, then only Chinese or English can be set as the message language. In this example, if the message language were changed to Korean, the menu language would also be changed to Korean.

* Japanese can only be set as the message language.

Setting the Click Sound

3. Press the **Click Sound** soft key to select ON or OFF.

Menu Language ENG	Message Language JPN	Click Sound OFF <input checked="" type="checkbox"/>	Date/Time	Offset Cancel OFF ON	System Cnfg MISC
----------------------	-------------------------	--	-----------	----------------------------	---------------------

Explanation

Setting the Menu Language

You can set the menus to display in English (ENG), Chinese (CHN), or Korean (KOR).

Setting the Message Language

When errors occur, and at other times, messages appear. You can specify to have these messages displayed in Japanese (JPN), English (ENG), Chinese (CHN), or Korean (KOR). The messages codes are common to each of these languages. For details on messages, see section 15.2.

Turning ON/OFF the Click Sound

Set whether or not to make click sounds when the jog shuttle is turned. The default setting is ON.

14.3 Turning OFF the Backlight and Setting the Brightness of the Backlight

Relevant Keys

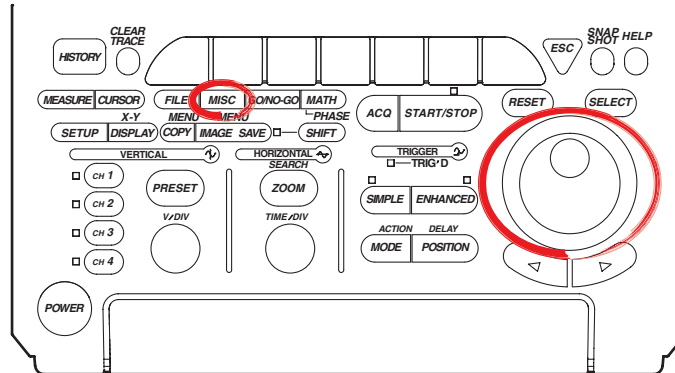

Operating Procedure

1. Press **MISC**.
2. Press the **Next 1/2** soft key.

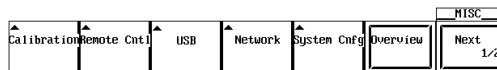

3. Press the **LCD** soft key to display the backlight ON/OFF menu.

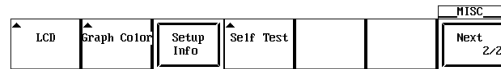

Setting Auto OFF

4. Press the **Auto OFF** soft key to select either ON or OFF.



5. If Auto OFF is turned ON, press the **Time** soft key. Using the jog shuttle, set the time at which the backlight will automatically turn OFF.

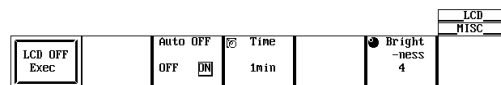

Setting the Brightness of the Backlight

6. Press the **Brightness** soft key. Using the jog shuttle, adjust the brightness of the backlight.

Turning ON/OFF the Backlight

7. Press the **LCD OFF Exec** soft key to turn OFF the backlight.



Press any key to return to the measurement screen.

Explanation

Turning ON/OFF the backlight (LCD OFF)

Turns ON/OFF the LCD backlight. If a key is pressed when the backlight is OFF, the screen returns to the measurement screen.

Automatically Turning OFF the Backlight (Auto OFF)

The backlight automatically turns OFF, if there is no key operation for the specified time.

Brightness of the Backlight (Brightness)

You can also change the brightness of the backlight.

The lifetime of the backlight can be prolonged by dimming the backlight or turning OFF the backlight when it is not necessary.

14.4 Canceling the Offset Voltage

Relevant Keys

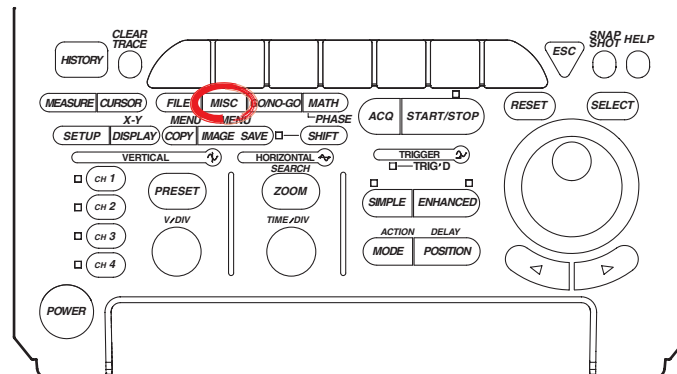

Operating Procedure

1. Press **MISC**.
2. Pressing the **System Cnfg** soft key displays the system configuration menu.

						MISC
Calibration	Remote Cntl	USB	Network	System Cnfg	Overview	Next 1/2

3. Press the **Offset Cancel** soft key to select ON or OFF.
The default value is OFF.

						System Cnfg
						MISC
Menu Language ENG	Message Language JPN	Click Sound OFF	Date/Time	Offset Cancel OFF	ON	

Explanation

You can select whether or not the offset voltage that is specified for each channel is reflected in the results of computations and automated measurement of waveform parameters.

OFF: Does not reflect the offset voltages in the results of computations and automated measurement of waveform parameters.

The vertical position of the display screen corresponds to the offset voltage.

ON: Reflect the offset voltages in the results of computations and automated measurement of waveform parameters.

The waveform that has offset voltage (DC voltage) removed from the input signal can be observed. In this case, the vertical position becomes 0 V.

Note

- Offset cancel applies to all channels.
- To set whether or not to cancel the offset for each channel, use linear scaling.

14.5 Changing the USB Keyboard Language/ Confirming the Type of Keyboard that is Connected(Optional)

Relevant Keys

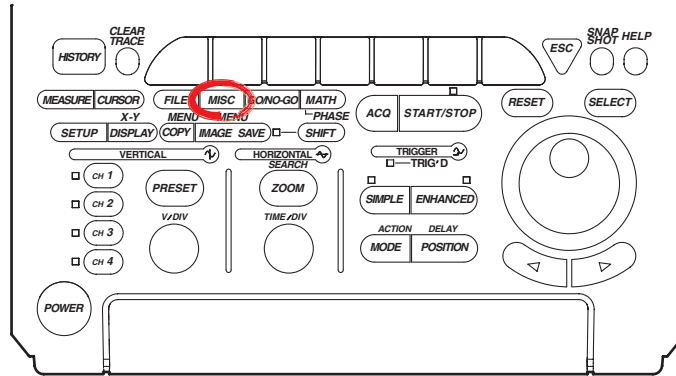

Operating Procedure

1. Press **MISC**.
2. Press the **USB** soft key.

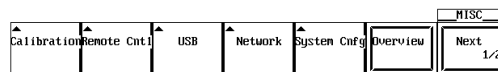

Changing the USB Keyboard Language

3. Press the **USB Keyboard** soft key to select ENG or JPN.

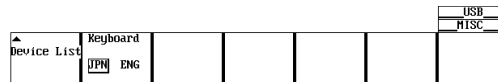

Confirming the Type of Keyboard that is Connected

3. Press the **USB List** soft key to display the USB Device List. Check the type of USB keyboard that is connected.

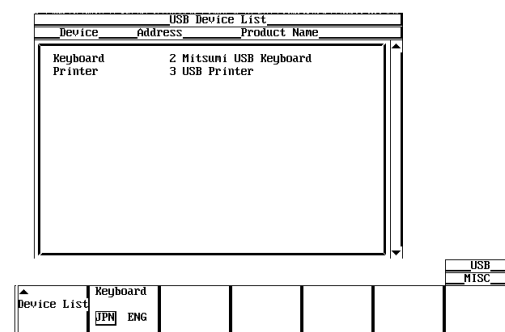

14.5 Changing the USB Keyboard Language/Confirming the Type of Keyboard that is Connected(Optional)

Explanation

The USB keyboard that can be used depends on the language (English or Japanese) selected.

A 104 USB keyboard (English) or a 109 USB keyboard (Japanese) that conforms to USB Human Interface Devices (HID) Class Ver. 1.1 can be used.

- ENG: 104 keyboard and 89 keyboard
- JPN: 109 keyboard and 89 keyboard

The default language is English.

15.1 Troubleshooting

Troubleshooting

For corrective actions when a message appears on the screen, read the following pages. If servicing is required or if the instrument does not operate properly after taking the following corrective actions, contact your nearest YOKOGAWA dealer.

Problem	Possible Cause	Corrective Action	Reference Section
The power cannot be turned ON.	The source voltage is outside the rated range.	Use a correct power supply.	3.3
	The main power switch on the rear panel is not turned ON.	Turn ON the main power switch.	
Nothing is displayed.	The backlight is turned OFF.	Press any key.	14.3
	The screen colors are not appropriate.	Select appropriate colors for the screen.	14.1
The display is abnormal.	The system is not operating correctly.	Turn ON the power again.	3.3
The waveform display is not updated.	Loaded waveform data from an external storage medium.	Unload the loaded waveform.	11.6
Keys do not work.	The instrument is in the remote mode.	Press SHIFT + CLEAR TRACE activate local mode.	—
	Other causes.	Execute a key test. If the test fails, servicing is required.	15.3
Triggering does not occur.	The trigger settings are not appropriate.	Set correct trigger settings.	Chapter 6
The measured values are odd.	Did not allow adequate warm-up time.	Allow at least 30 minutes for the instrument to warm-up after turning ON the power.	—
	The instrument has not been calibrated.	Perform calibration.	4.7
	The probe's phase has not been corrected.	Correct the phase properly.	3.5
	The probe attenuation is not correct.	Set to the correct value.	5.4
	An offset voltage is added. Other causes	Set the offset voltage to zero. Perform calibration. If the measured values are still odd, servicing is required.	5.5 4.7
Cannot output to the internal printer.	The printer head is damaged or worn out.	Servicing is required.	15.6
Output from internal printer is blurred.	The printer head is dirty.	Perform the self test for the internal printer. This can eliminate dirt from the printer head.	15.6
Cannot save to the medium.	The medium has not been formatted.	Format the medium.	11.5
	The medium is write protected.	Remove the write protection from the medium.	—
	Insufficient space on the medium.	Delete unnecessary files or use a new medium.	11.11
The instrument cannot be configured or controlled via the communication interface.	The address used in the program is different from the actual address. The GP-IB interface is not being used according to the electrical and mechanical specifications.	Use the same address in the program and the instrument. Comply with the specifications.	Communication Interface User's Manual (IM701610-17E)

15.2 Messages and Corrective Actions

Error Messages

If an error occurs during operation, an error code may appear on the screen. This section describes the meanings of the error messages and the corrective actions which they require. The messages can be displayed either in English or Japanese (see section 14.2). If the corrective action requires servicing, contact your nearest YOKOGAWA dealer.

In addition to the error messages listed in this section, there are also communication related error messages. These messages are described in the Communication Interface User's Manual (IM701610-17E).

Status Messages

Code	Message	Description	Reference Section
0	Aborted hard copy.	—	10.2
1	Aborted file operation.	—	Chapter 11
2	Completed data store.	—	4.4
3	Completed data recall.	—	4.4
4	Completed GO/NO-GO.	—	9.9, 9.10
10	Set to remote mode by communication commands.	Press SHIFT+ CLEAR TRACE to change to local mode.	—
11	Local lockout by communication commands.	To allow key operation, release the lockout using communication commands	—
13	All settings will be initialized. Power up with the RESET key depressed.	—	4.2
21	Completed action-on-trigger.	—	6.15
22	Executed unload.	—	11.6, 11.8
23	Release the Preview mode.	—	10.2
25	Aborted the search.	—	7.7, 7.8, 8.9
26	Executed the search, but no record was found that matched the conditions.	—	7.7, 7.8
27	Executed the search, but no pattern was found that matched the conditions.	—	8.9
28	Pattern contains points that are between Thr Lower and Thr Upper.	—	8.9
29	FFT will be performed on all records. Abort the operation by setting the history Display Mode to One.	—	—
30	Aborted the recalculation of the FFT.	—	—
32	Aborted statistical measurement processing.	—	9.3
36	Key invalid for this model.	—	—
37	Analysis aborted.	—	—
38	Data not detected. Execute again after changing the settings or reacquiring the waveform.	—	—
39	The corresponding field was not found.	—	—
40	The frame contains indefinite data (greater than Thr Lower but less than Thr Upper).	—	—
41	Bandwidth filter not set.	—	5.7, 7.4
42	Power supply batter is flat. Please do charge of the battery or replace	—	—

Error in Execution (600 to 879)

Code	Message	Corrective Action	Reference Section
601	Invalid file name.	Check the file name.	—
602, 603	No storage media inserted.	Check the presence of the medium.	—
604	Storage media failure.	Check the medium.	—
605	File not found.	Check the filename and the medium.	Chapter 11
606	Storage media is protected.	Set the disk's write protect switch to OFF.	—
607	Storage media failure.	Check the medium.	—
608 to 610	Invalid file name.	Check the file name.	—
611, 612	Storage media full.	Delete unnecessary files or use another disk. The number of bytes necessary is given in the pages indicated on the right.	11.11
613	Cannot delete a directory if there are files in the directory.	Delete all files in the directory before deleting the directory.	11.11
614	File is protected.	Clear the write disable (*) mark.	11.11
615	Physical format error.	Reformat the medium. If the same error occurs, this instrument cannot format the medium.	11.5
616 to 620	File system failure.	Check using another medium. If the same message still appears, servicing is required.	—
621	File is damaged.	Check the file.	—
622 to 641, 656 to 663	File system failure.	Check using another medium. If the same message still appears, servicing is required.	—
646 to 653	Storage media failure.	Check the medium	—
654	Storage media failure.	Check the floppy disk's format type.	11.5
665	Cannot load this file format.	Files stored on other models (DL/AG series) cannot be loaded.	—
666	File is now being accessed. Wait a moment.	Execute after accessing is finished.	—
667	Cannot be executed while data acquisition is in progress.	Press START/STOP to stop the waveform acquisition.	4.5
668	Cannot find '.HDR' file.	Check the file.	11.6
669	Cannot load the specified file on this ROM version or this model.	Upgrade the ROM version (upper compatible).	—
671	Save data not found.	Check the presence of data to be stored.	—
676	Unknown file format.	Check whether the data file in a format that is supported. Change the file extension.	11.12
677	P-P compression cannot be used to save FFT waveforms.	Turn OFF the P-P compression.	11.6
679	Data that have been P-P compressed and saved cannot be loaded.	—	—
680	Cannot load waveform data that has been saved in history All mode when With Setup mode is OFF. Please turn With Setup mode ON.	—	11.6
681	Cannot load waveform data that has been saved in trace All mode when With Setup mode is OFF. Please turn With Setup mode ON.	—	11.6
682	Cannot load waveform data of more than 8 M record length when With Setup mode is OFF. Please turn With Setup mode ON.	—	11.6
683	Cannot load compressed waveform data of more than 8 M record length.	—	11.6
684	Cannot load waveform data that has been compressed and saved in history All mode.	—	11.6

15.2 Messages and Corrective Actions

Code	Message	Corrective Action	Reference Section
700	Illegal printer head position.	Set the release arm to the "HOLD" position.	10.1
701	Paper empty.	Load a paper roll.	10.1
702	Printer overheated.	Turn OFF the power immediately. Servicing is required.	—
703	Printer overheated.	Turn OFF the power immediately. Servicing is required.	—
704	Printer is not installed.	Check that the printer is installed.	ii
705	Printer time out.	Servicing is required.	—
711	The printer has malfunctioned.	Servicing is required.	—
712	Printer error. Turn the power of the printer from OFF to ON.	—	—
713	Printer offline.	—	—
714	Out of paper.	—	—
715	Printer is in use.	—	—
716	Cannot detect printer. Turn ON the printer. Check connectors.	—	—
717	No files supporting the thumbnail display window.	—	10.4
741	Cannot be executed while data acquisition is in progress.	Press START/STOP to stop the waveform acquisition.	4.5
743	There is no data to be undone.	Cannot undo because the data were cleared during initialization or auto setup.	4.2, 4.3
744	Cannot be executed while data acquisition is in progress.	Press START/STOP to stop the waveform acquisition.	4.5
745	This data cannot be backed up.	—	—
746	There is no data to be recalled.	—	4.4
747	Cannot start during data output.	Wait until data output is complete.	Chapter 10
751	Cannot access file while hard-copying.	Wait until the hard copy completes.	10.2
752	Cannot compress this screen image. Turn off the compression switch.	Turn OFF the compression setting.	10.3
753	Calibration failure. Disconnect the input and execute again. If it fails again, servicing is required.	Servicing is required.	—
766	Cannot start when loading waveform data that has been saved in history All mode.	Unload the files.	11.6
767	Insufficient output data. Increase Mag or widen the Time Range interval.	Increase Mag or widen the Time Range interval.	10.2
768	Hard copying. Abort or wait until it is complete.	Pressing Copy again aborts the operation.	10.2
769	Cannot perform calibration while waveform data is loaded.	Unload the loaded files from the FILE menu.	11.6
770	Pattern is not specified.	Set at least one search pattern not to X.	8.9
771	Cannot start when waveform data that has been acquired in the linear average mode is loaded.	Unload the loaded files from the FILE menu.	11.6
772	Cannot be executed while computation is in progress.	Aborted when Math/Display is turned Off.	9.5
773	Failed to measure statistics. The target waveform data exists or the measured waveform data may not exist. If Cycle Statistic is specified, the instrument may be configured in a way that fails to detect the cycle.	Check that there is at least one period of waveform within the measurement range.	9.3
775	Cannot store because the data is locked. Release the lock through Store Detail.	Release the lock through Store Detail.	4.4

Code	Message	Corrective Action	Reference Section
776	The File item is inappropriate. Select Waveform, Snap, or Measure.	Select Waveform, Snap, or Measure.	—
777	Executing file Load, Save, or Format. Abort or wait until it is complete.	—	—
778	Hard copying or saving image. Abort or wait until it is complete.	—	—
779	Specified data does not exist. Execute the analysis.	—	—
780	Failed to process statistics. The target waveform data may not exist.	—	9.1
810	Cannot connect to the server.	Confirm the network settings and connection.	Chapter 13
811	Not yet connected to the ftp server.	Confirm the network settings and connection.	Chapter 13
812	This ftp function in not supported.	—	Chapter 13
813	FTP Error: Rwd	Confirm the network settings and connection.	Chapter 13
814	FTP Error: Cwd	Confirm the network settings and connection	Chapter 13
815	FTP Error: Rm	Confirm the network settings and connection.	Chapter 13
816	FTP Error: List	Confirm the network settings and connection.	Chapter 13
817	FTP Error: Mkdir	Confirm the network settings and connection.	Chapter 13
818	FTP Error: Rmdir	Confirm the network settings and connection.	Chapter 13
819	FTP Error: Get	Confirm the network settings and connection.	Chapter 13
820	FTP Error: Put	Confirm the network settings and connection.	Chapter 13
821	FTP Error: GetData	Confirm the network settings and connection.	Chapter 13
822	FTP Error: PutData	Confirm the network settings, connection, and disk capacity.	Chapter 13
823	FTP Error: AppendData	Confirm the network settings, connection, and disk capacity.	Chapter 13
824	FTP Error: Client Handle	Confirm the network settings and connection.	Chapter 13
825	FTP Error: Others	Confirm the network settings and connection.	Chapter 13
845	Cannot send data to a network printer.	Confirm the network settings and connection.	Chapter 13
846	Cannot send the e-mail message.	Confirm the network settings and connection.	Chapter 13
857	Connecting to a NetDrive. Wait until connection has been established.	—	Chapter 13
858	Failed to initialize network.	Confirm the network settings,	Chapter 13
859	The second time password is different from the first time. Please repeat the second time password input.	Set a correct password.	Chapter 13
860	Failed to acquire time from SNTP server. Confirm the network settings and connections.	Confirm the network settings and connection.	Chapter 13

Error in Setting (880 to 959)

Code	Message	Corrective Action	Reference Section
880	Illegal date/time.	Set a correct date and time	3.6
881	Illegal file name.	The file name contains characters that are not allowed or the file name is restricted in MS-DOS.	4.1
884	Cannot change this parameter while data. acquisition is in progress.	Press START/STOP to the waveform acquisition.	4.5
886	GO/NO-GO is in execution. Please press the Abort key.	All keys other than START/STOP are disabled during GO/NO-GO determination.	9.9, 9.10
894	Duplicated label.	Set a different label.	8.5
899	Cannot change when Channel Display is OFF or Math settings are invalid.	Turn ON the channel display or set Math operation.	5.1 9.5 to 9.7
901	Cannot change when ExtClock is active.	Change the timebase to Internal.	5.11
916	Cannot change settings during action-on-trigger.	Select Abort or press START/STOP .	4.5, 6.15

15.2 Messages and Corrective Actions

Code	Message	Corrective Action	Reference Section
920	Cannot set the acquisition mode to Average when the trigger mode is set to Single or Single(N).	Change the acquisition mode or the trigger mode.	6.1, 7.2
921	It is not possible to make a setting that will result in the repetitive mode when the trigger mode is set to Single (N).	Setting or set the trigger mode to a different mode.	6.1
923	Cannot set the trigger mode to Single or Single(N) when the acquisition mode is Average.	Change the acquisition mode or the trigger mode.	6.1, 7.2
926	Cannot set the trigger mode to Single(N) during repetitive sampling mode.	Turn OFF the repetitive sampling mode, lower the T/div setting, or shorten the record length.	5.12, 7.1
927	Cannot set this parameter during repetitive sampling mode.	Turn OFF the repetitive sampling mode, lower the T/div setting, or shorten the record length.	5.12, 7.1
930	Not possible in the current record length.	Change the record length.	7.1
931	Cannot carry out computation at the current record length.	Change the record length.	7.1
932	The operation is not possible when waveforms are loaded. Unload the loaded files from the FILE menu.	Unload the files.	11.6
933	Setting or executing is not possible during the search operation.	Abort the search.	7.7, 7.8
934	Search pattern does not exist. Execute the search.	Change the search conditions.	8.9
935	Settings cannot be changed or executed during the history search operation.	Abort the search.	7.7, 7.8
936	The record cannot be selected	Check the record number using Show Map.	7.7, 7.8
937	History record does not exist.	History record is not created in the average mode, repetitive sampling mode, or roll mode.	7.2
938	Setting or executing is not possible during FFT recalculation. Abort the operation by setting the history Display Mode to One.	Set the history Display Mode to One.	7.6
940	Cannot be configured or executed while updating the history all display. Aborted when history display mode is set to One.	Set the history Display Mode to One.	7.6
941	Cannot output color in this format.	Turn OFF the color.	10.3
942	Zones cannot be edited in the following cases: • When the main window is not displayed. • When the target waveform is not displayed.	Display the main window and the target waveform.	9.9
943	The zone waveform does not exist.	Create the zone waveform.	9.9
944	The zone is being edited. To perform other operations, select Quit to exit zone editing.	Select Quit to exit zone editing.	9.9
945	Zones determination is not possible in the following cases: • When the main window is not displayed. • When the target waveform is not displayed. • When the zone waveform does not exist.	Display the main window and the target window and create the zone waveform.	9.9
948	Processing statistics. To perform other operations, abort the statistical processing.	Abort statistical processing.	9.3
949	Settings cannot be entered in the current trigger mode. Set the trigger mode to Single.	—	6.1
950	Setting not allowed. Invalid byte or bit.	—	—
951	Cannot be set when CS channels are not specified.	—	—

System Operation Errors (960 to 968, 972 to 981)

Code	Message	Corrective Action	Reference Section
952	Cannot set this parameter when the acquisition mode is Average.	—	7.2
961	Failed to backup setup data. Will initialize.	Check the condition of the built-in lithium battery using the overview screen. Servicing is required.	—
966	Fan stopped ; Turn off the power immediately	Turn OFF the power immediately. Servicing is required.	—
967	Backup battery is flat	Servicing is required to replace the battery.	—
972	Fatal error in the communication driver	Servicing is required.	—
982	The USB devices power consumption exceeded the capacity of the USB hub.	—	16.8
983	The voltage of power supply battery is too low. Turn off the power immediately. Please do charge of the battery or replace.	Check the output from the DC power supply being used.	3.3
984	The voltage of power supply battery is too high. Turn off the power immediately. Confirm the voltage of the battery.	Check the output from the DC power supply being used.	3.3

Note

When servicing is required, double-check by initializing the instrument.

15.3 Self-Diagnostic Test (Self Test)

Relevant Keys

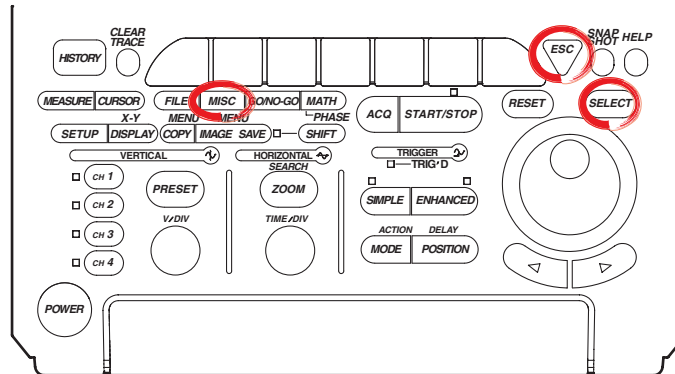

Operating Procedure

Displaying the Self Test Menu

1. Press **MISC**.
2. Press the **Next 1/2** soft key to display the self test soft key menu.

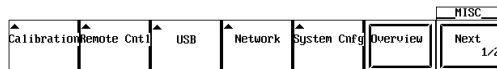

3. Press the **Self Test** soft key to display the self test menu.
Go to step 4 for a memory test, step 9 for a key test, step 13 for a printer test, and step 16 for a floppy disk drive test, a Zip drive test, a PC card drive test or an accuracy test.

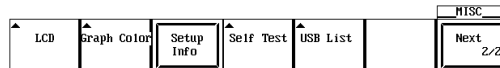

Execute the Memory Test

4. Pressing the **Test Item** soft key displays the test item menu.



5. Press the **Memory** soft key to be tested.

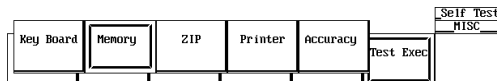

6. Pressing the **Test Exec** soft key executes the memory test.

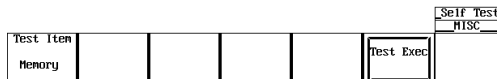

Executing the Key Test

7. After step 3, press the **Test Item** soft key to display the test item menu.
8. Press the **Key Board** soft key to be test.

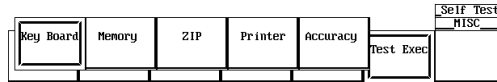

9. Pressing the **Test Exec** soft key executes the key test.

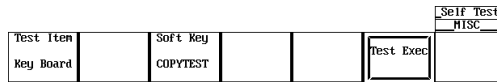

10. Press all the keys. To terminate the key test, press **ESC** twice.

Testing the Soft Keys

11. Pressing the **Soft Key** soft key displays a keyboard.
12. Using the jog shuttle and **SELECT**, check that the characters on the keyboard can be entered correctly. Pressing **ESC** twice clears the keyboard.

Executing the Printer Test

13. After step 3, press the **Test Item** soft key to display the test item menu.
14. Press the **Printer** soft key to be test.

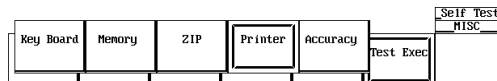

15. Pressing the **Test Exec** soft key executes the printer test.



Testing the FDD, Zip Drive, PC Card Drive, or Accuracy

16. After step 3, press the **Test Item** soft key to display the test item menu.
17. Press the soft key corresponding to the **FDD**, **ZIP**, **PC CARD**, or **Accuracy** test.

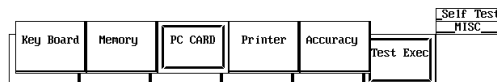

18. Pressing the **Test Exec** soft key executes the selected test.



Note

Insert a floppy disk, a Zip disk, or a PC card before executing the FDD, Zip, or PC card test.

Explanation

Memory Test

This test checks the internal ROM. The ROM is functioning correctly, if Pass is displayed. If Failed is displayed, contact your nearest YOKOGAWA dealer as listed on the back cover of this manual.

Key Test

Tests whether or not the front panel keys are operating correctly. If the name of the key that is pressed is highlighted, then it is operation correctly. If it does not, contact your nearest YOKOGAWA dealer as listed on the back cover of this manual.

Floppy Disk Drive/Zip Drive/PC Card Drive Test

This test checks the floppy disk drive, Zip drive, or PC card drive. If Failed is displayed, contact your nearest YOKOGAWA dealer as listed on the back cover of this manual.

Printer Test

This test checks the optional built-in printer. The printer is functioning correctly if gray shading is printed properly. If it is not, contact your nearest YOKOGAWA dealer as listed on the back cover of this manual.

Accuracy Test

This test checks A/D accuracy. If Failed is displayed, contact your nearest YOKOGAWA dealer as listed on the back cover of this manual.

15.4 Checking the System Condition

Relevant Keys

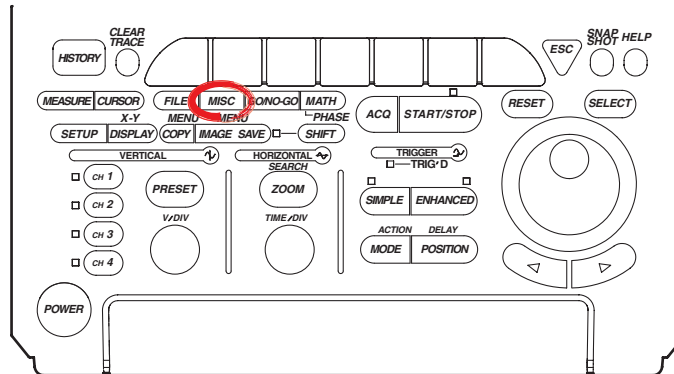

Operating Procedure

1. Press **MISC**.
2. Pressing the **Overview** soft key displays the overview screen. Pressing any key clears the overview screen.

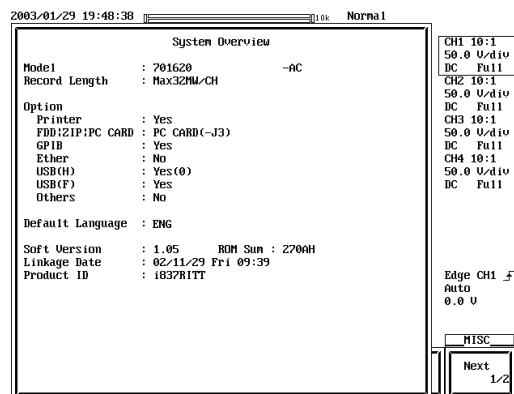
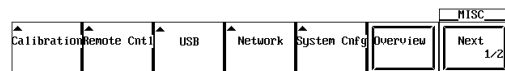

Explanation

This function allows you to check the ROM version, model, and installed options. The screen is shown in the procedure.

15.5 Resetting the Circuit Breaker (DC Power Supply Model)

Circuit Breaker Position

A protective circuit breaker is installed on the rear panel in place of a power supply fuse.

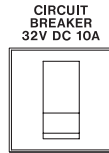

Circuit Breaker Activation

If an overload occurs and excessive current flows, the power supply is cut. When this happens the reset button trips as shown in the figure below, and the white indicator is exposed.

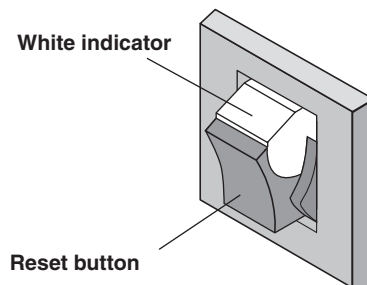

Resetting the Circuit Breaker

When the circuit breaker activates and the power supply is cut, wait 1 minute then push in the Reset button. The Reset button returns to its original position. If the overload continues, the Reset button will not return to its original position.

CAUTION

- When the circuit breaker activates and the power supply is cut, this may indicate an abnormality in the internal circuitry. If the Reset button does not return to its original position regardless of how many times you repeat the reset procedure, contact your nearest YOKOGAWA dealer.

15.6 Recommended Replacement Parts

The three-year warranty applies only to the main unit of the instrument (starting from the day of delivery) and does not cover any other items such as expendable items (items which wear out). Contact your nearest YOKOGAWA dealer for replacement parts.

Parts Name	Limited Life
Built-In Printer	Under normal usage, 120 rolls of paper (part No.: B9850NX)
LCD Back Light	Approx. 25000 hours when used continuously

The following parts are wear out parts. We recommend you replace them periodically as indicated below. Contact your nearest YOKOGAWA dealer for replacement parts.

Parts Name	Recommended Replacement Period
Cooling Fan	3 years
Backup Battery (Lithium Battery)	5 years

16.1 Input Section

Item	Specifications
Number of Input Channels	4 (CH1 to CH4), or 2 (CH1 to CH2) for the DL1620
Input Coupling Settings	AC 1 M Ω , DC 1 M Ω , GND
Input Connector	BNC
Input Impedance	1 M Ω \pm 1.0%, approx. 28 pF
Voltage Axis Sensitivity Setting	1 M Ω input : 2 mV/div to 10 V/div (1-2-5 steps)
Maximum Input Voltage	1 M Ω input (at 1 kHz or less): 300 V DC or 300 V RMS CAT I, 424 V peak
DC Offset Range (Max)	2 mV/div to 50 mV/div : \pm 1 V
(At 1 : 1 probe attenuation)	100 mV/div to 500 mV/div : \pm 10 V 1 V/div to 5 V/div : \pm 100 V 10 V/div : \pm 50 V
Vertical (Voltage) Axis Precision	
DC Precision ^{*1}	2 mV/div to 5 mV/div : \pm (2% of 8 div + offset voltage precision) 10 mV/div to 10 V/div : \pm (1.5% of 8 div + offset voltage precision)
Offset Voltage Precision ^{*1}	2 mV/div to 50 mV/div : \pm (1% of set value + 0.2 mV) 100 mV/div to 500 mV/div : \pm (1% of set value + 2 mV) 1 V/div to 10 V/div : \pm (1% of set value + 20 mV)
Frequency Characteristics ^{*1*2}	1 M Ω input (BNC terminal) 10 V/div to 10 mV/div : DC to 200 MHz 5 mV/div to 2 mV/div : DC to 80 MHz
(-3 dB point when sine wave of amplitude \pm 4 div is input)	1 M Ω input (defined at the tip of the probe when using the passive probe 700960) 10 V/div to 10 mV/div : DC to 200 MHz 5 mV/div to 2 mV/div : DC to 80 MHz
-3 dB Point for AC Coupling Used	10 Hz or less (When using the 10 : 1 probe (standard accessory), 1 Hz or less)
Interchannel Skew (with identical settings)	1 ns or less
Residual Noise ^{*3}	Larger of \pm 1.25 mV or \pm 0.15 div (typical ^{*4})
Interchannel Isolation (at identical voltage sensitivity)	200 MHz : -35 dB (typical ^{*4})
A/D Conversion Resolution	8 bits (24 LSB/div)
Probe Attenuation Settings	1 : 1, 10 : 1, 100 : 1, 1000 : 1, 10 A : 1 V ^{*5} , 100 A : 1 V ^{*5}
Bandwidth	10 kHz to 20 MHz band limit ON/OFF
Maximum Sample Rate	Realtime sampling mode : 200 MS/s Repetitive sampling mode: 50 GS/s
Maximum Record Length	High-resolution mode ON : (DL1620/DL1640) 4 Mwords/CH, (DL1640L) 16 Mwords/CH High-resolution mode OFF : (DL1620/DL1640) 8 Mwords/CH, (DL1640L) 32 Mwords/CH

*1 As measured following calibration (after 30-minute warmup), with internal-clock timebase, under standard operating conditions as described on section 16.11.

*2 For repetitive events
The frequency region for single shot is DC to sampling frequency/2.5 or the frequency region for the repetitive event, whichever is less.

*3 Measured under following conditions: input block shorted; 10 kWord record length; Normal acquisition mode; accumulation OFF; 1 : 1 probe attenuation

*4 The typical value is a representative or standard value. It is not a warranted value.

*5 Setting made to match the type of optional current probe being used, respectively 700937, 701930, 701931, 701932, and 701933.

16.2 Trigger Section

Item	Specifications
Trigger Mode	Auto, Auto Level, Normal, Single, Single(N)
Trigger Source	CH1 to CH4 (or CH1 to CH2 for the DL1620), EXT, LINE (Only on models with "-AC" suffix)
Trigger Coupling	CH1 to CH4 (or CH1 to CH2 for the DL1620) : DC, AC EXT : DC
HF Rejection	Trigger source band limit (OFF, DC to approx. 15 kHz) selection (CH1 to CH4, or CH1 to CH2 for the DL1620)
Trigger Hysteresis	Select the trigger hysteresis width
Trigger Level Setting Range	CH1 to CH4 : ± 4 div from screen center (CH1 to CH2 for the DL1620) EXT : ± 2 V for the DL1640/DL1640L : ± 1 V for the DL1620 with the ± 1 V range selected : ± 10 V for the DL1620 with the ± 10 V range selected
Trigger Level Resolution	CH1 to CH4 : 0.01 div for the DL1640/DL1640L (CH1 to CH2 for the DL1620) EXT : 5 mV for the DL1640/DL1640L : 5 mV for the DL1620 with the ± 1 V range selected : 50 mV for the DL1620 with the ± 10 V range selected
Trigger Level Precision ^{*1}	CH1 to CH4 ^{*1} : $\pm(1 \text{ div} + 10\% \text{ of trigger level})$ (CH1 to CH2 for the DL1620) EXT ^{*2} : $\pm(50 \text{ mV} + 10\% \text{ of trigger level})$ for the DL1640/DL1640L : $\pm(50 \text{ mV} + 10\% \text{ of trigger level})$ for the DL1620 with the ± 1 V range selected : $\pm(500 \text{ mV} + 10\% \text{ of trigger level})$ for the DL1620 with the ± 10 V range selected
External-Trigger Probe Attenuation	1 : 1, 10 : 1
Trigger Sensitivity ^{*2}	CH1 to CH4 : 1 div _{P-P} (at DC to 200 MHz) (CH1 to CH2 for the DL1620) EXT : 300 mV _{P-P} (at DC to 100 MHz) for the DL1640/DL1640L : 100 mV _{P-P} (at DC to 100 MHz) for the DL1620 with the ± 1 V range selected : 1 V _{P-P} (at DC to 100 MHz) for the DL1620 with the ± 10 V range selected
Trigger Position	Can be set in 1% increments of record length
Trigger Delay Setting Range	0 to 4 s
Hold Off Time Range	80 ns to 10 s
Trigger Slope	Rise, Fall, Rise/Fall (with edge trigger)

Item	Specifications
Trigger Type	Edge : Activate the trigger on the edge of a single trigger source.
	A → B(N) : Trigger occurs nth time condition B becomes true after condition A becomes true. Count : 1 to 10 ⁸ Condition A: Enter, Exit Condition B: Enter, Exit
	A Delay B : Trigger occurs first time condition B becomes true after specified delay following condition A true. Delay : 5 ns to 5 s Condition A: Enter, Exit Condition B: Enter, Exit, Both
	OR : Trigger occurs on the OR of trigger conditions that are specified on multiple trigger sources. The trigger condition can either be edge or window. Rise (IN), Fall (OUT), or Don't Care can be specified on each channel from CH1 to CH4.
	Pattern : Trigger occurs on the edge of the clock channel based on the True/False condition of the parallel pattern that is specified on multiple trigger sources. If the clock channel is set to Don't Care, then the trigger occurs only on the True or False condition (Enter or Exit) of the parallel pattern. The parallel pattern is the AND of the channel states of each channel.
	Pulse Width : Trigger occurs on the width of the True/False condition of the parallel pattern that is specified on multiple trigger sources. The parallel pattern is the AND of the channel states of each channel or the AND of the window conditions of each channel.
	Pulse>T : Triggers when the width above is greater than T. Setting range: 0.005 μs to 1000000.000 μs
	Pulse<T : Triggers when the width above is less than T. Setting range: 0.0075 μs to 1000000.000 μs
	T1<PLS<T2 : Triggers when the width above is greater than T1 and less than T2. Setting range T1: 0.005 μs to 999999.995 μs T2: 0.010 μs to 1000000.000 μs
	$\overline{T1}<PLS<\overline{T2}$: Triggers when the width above is greater than T1 and T2. Setting range T1: 0.0075 μs to 999999.995 μs T2: 0.010 μs to 1000000.000 μs
	Time out : Triggers when the width above exceeds Time. Setting range 0.005 μs to 1000000.000 μs
	Time accuracy* ¹ : ±(0.5% of setting* ³ + 1 ns) Minimum detectable time* ² : 5 ns (typical value* ⁴)
	TV : Trigger for video signal, in NTSC, PAL, 1080/60i, 1080/50i, 720/60p, 480/60p, 1080/25p, 1080/24p, 1080/24sF, or 1080/60ps format. Input channel must be CH1. User can select field no. and line no. • Conditions A and B are parallel pattern conditions that are set separately to High, Low, or "Don't Care" for each channel and for EXT input.

*1 As measured immediately after calibration, under standard operating conditions (see section 16.11), with machine warmed up.

*2 As measured under standard operating conditions (see section 16.11) after warmed up.

*3 When set to T1<Pulse<T2, the value of T2.

*4 The typical value is a representative or standard value. It is not a warranted value.

16.3 Time Axis

Item	Specifications
Time Axis Range	DL1620/DL1640 2 ns/div to 800 s/div (record length is 8 Mwords) 2 ns/div to 500 s/div (record length is 100 kword or 1 Mwords) 2 ns/div to 50 s/div (record length is 10 kwords) 2 ns/div to 5 s/div (record length is 1 kwords) DL1640L 2 ns/div to 800 s/div (record length is 16 Mwords(high resolution mode) or 4 Mwords) 2 ns/div to 640 s/div (record length is 32 Mwords(high resolution mode is OFF)) 2 ns/div to 500 s/div (record length is 100 kwords, 1 Mwords, or 10 Mwords) 2 ns/div to 50 s/div (record length is 10 kwords) 2 ns/div to 5 s/div (record length is 1 kwords)
Timebase Precision ^{*1}	±(0.005%)
Time Axis Precision ^{*1}	±(0.005% + 50 ps + 1 digit) ^{*2}
EXT CLOCK IN	Connector Type BNC Maximum Input Voltage ±40 V(DC + ACpeak) or 28 Vrms, 10 kHz or less Input Frequency Range 40 Hz to 5 MHz (continuous clock only) Sampling Jitter ±10 ns or less Minimum Input Level 0.3 V _{P-P} for the DL1640/DL1640L 0.1 V _{P-P} for the DL1620 with the ±1 V range selected 1 V _{P-P} for the DL1620 with the ±10 V range selected Threshold Level ±2 V (5 mV resolution) for the DL1640/DL1640L ±1 V (5 mV resolution) for the DL1620 with the ±1 V range selected ±10 V (50 mV resolution) for the DL1620 with the ±10 V range selected Input Impedance Approx. 1 MΩ, 28 pF Minimum Pulse Width At least 10 ns (for both High and Low)

*1 As measured under standard operating conditions (see section 16.11) after warmed up.

*2 1 digit may be unreliable depending on the sampling.

16.4 Display

Item	Specifications
Display	6.4-inch color TFT liquid crystal display
Screen Size	130.6 mm (width) × 97.0 mm (height)
Total Picture Elements ^{*1}	640 × 480 dots
Waveform Picture Elements	500 × 384 dots

*1 The liquid crystal display (LCD) may contain a number of defective pixels. (Up to 40 pixels per million of the color LCD may be defective.) Therefore, there may be a small number of "lit" or "dead" pixels on the LCD. This is not a malfunction.

16.5 Functions

Acquisition/Display

Item	Specifications
Acquisition Mode	Select from four modes: Normal, Averaging, Envelope.
Sampling Mode	Select realtime or repetitive sampling. (Availability depends on time axis settings.)
High-resolution Mode	If combined with a filter, improves the S/N ratio up to a maximum of 13 bits.
Record Length	DL1620/DL1640 : 1 kword, 10 kwords, 100 kwords, 1 Mword, 8 Mwords DL1640L : 1 kword, 10 kwords, 100 kwords, 1 Mword, 4 Mwords, 10 Mwords, 32 Mwords
Zoom	Can zoom up to 2 time axis ranges of displayed waveform(s).
Display Format	1, 2, or 4 waveform windows.
Interpolation	Display samples using dot display, "sine" interpolation, linear interpolation, or pulse interpolation.

Item	Specifications
Graticule	Select from three graticule types.
Auxiliary Display Items	Select display or nondisplay of scale values, waveform labels, or trigger mark.
X - Y Display	Display two X-Y waveform (XY1 or XY2).
Accumulation	Displays multiple iterations of waveform, in either "persistence mode" or "color-grade mode."
Snapshot	Freezes the current waveform on screen. Saves or loads the snapshot waveforms.
Trace Clear	Removes the currently displayed waveform.

Vertical/Horizontal Axis Setting

Item	Specifications																									
Channel ON/OFF	Independent ON or OFF for each channel.																									
Input Filter	Set a 20 MHz, 1.28 MHz, 640 kHz, 320 kHz, 160 kHz, 80 kHz, 40 kHz, 20 kHz, or 10 kHz band limit ON or OFF independently for each channel.																									
Vertical Position Setting	Waveforms can be moved vertically in the range ± 4 div from the center of the waveform display frame.																									
Linear Scaling	Set scaling coefficient, offset, and unit separately for each channel.																									
Roll Mode	The roll display mode is enabled when the trigger mode is auto, auto-level, or single and the time axis is as follows. <table border="1"> <thead> <tr> <th>Model</th> <th>Record Length</th> <th>T/div</th> </tr> </thead> <tbody> <tr> <td rowspan="3">DL1620/ DL1640</td> <td>1 kwords</td> <td>50 ms/div to 5 s/div</td> </tr> <tr> <td>10 kwords</td> <td>50 ms/div to 50 s/div</td> </tr> <tr> <td>100 kwords to 1 Mwords</td> <td>50 ms/div to 500 s/div</td> </tr> <tr> <td rowspan="6">DL1640L</td> <td>8 Mwords</td> <td>200 ms/div to 800 s/div</td> </tr> <tr> <td>1 kwords</td> <td>50 ms/div to 5 s/div</td> </tr> <tr> <td>10 kwords</td> <td>50 ms/div to 50 s/div</td> </tr> <tr> <td>100 kwords to 1 Mwords</td> <td>50 ms/div to 500 s/div</td> </tr> <tr> <td>4 Mwords</td> <td>100 ms/div to 800 s/div</td> </tr> <tr> <td>10 Mwords</td> <td>500 ms/div to 500 s/div</td> </tr> <tr> <td>32 Mwords</td> <td>1 s/div to 640 s/div(500 ms/div to 800 s/div)</td> </tr> </tbody> </table> <p>Ranges in parentheses () take effect in high resolution mode.</p>	Model	Record Length	T/div	DL1620/ DL1640	1 kwords	50 ms/div to 5 s/div	10 kwords	50 ms/div to 50 s/div	100 kwords to 1 Mwords	50 ms/div to 500 s/div	DL1640L	8 Mwords	200 ms/div to 800 s/div	1 kwords	50 ms/div to 5 s/div	10 kwords	50 ms/div to 50 s/div	100 kwords to 1 Mwords	50 ms/div to 500 s/div	4 Mwords	100 ms/div to 800 s/div	10 Mwords	500 ms/div to 500 s/div	32 Mwords	1 s/div to 640 s/div(500 ms/div to 800 s/div)
Model	Record Length	T/div																								
DL1620/ DL1640	1 kwords	50 ms/div to 5 s/div																								
	10 kwords	50 ms/div to 50 s/div																								
	100 kwords to 1 Mwords	50 ms/div to 500 s/div																								
DL1640L	8 Mwords	200 ms/div to 800 s/div																								
	1 kwords	50 ms/div to 5 s/div																								
	10 kwords	50 ms/div to 50 s/div																								
	100 kwords to 1 Mwords	50 ms/div to 500 s/div																								
	4 Mwords	100 ms/div to 800 s/div																								
	10 Mwords	500 ms/div to 500 s/div																								
32 Mwords	1 s/div to 640 s/div(500 ms/div to 800 s/div)																									

Analysis

Item	Specifications
Search and Zoom Function	Search for, then expand and display a portion of the displayed waveform. Choose from the following five search methods. Edge : Count the rising or falling edges, and automatically search either edge. Serial Pattern : Automatically search a serial pattern (up to 64 bits) with a synchronized or unsynchronized clock. Parallel Pattern : Automatically search a parallel pattern from CH1-CH4, Math1, Math2(CH1-CH2, Math1 for the DL1620) Pulse Width : Automatically search for parts where a pulse width meets specified conditions. Auto Scroll : Automatically scroll the zoom position.
History Search Function	You can search for and display waveforms from the history memory that satisfy specified conditions. Choose from the following two search methods. Zone : Set an area on the screen, then extract and display only those waveforms that pass through the area (Pass mode), or do not pass through the area (By Pass mode). Parameter : Extract and display only the automatic measurement results of the waveform parameters which meet the specified conditions.
Cursor Measurement Function	Allows selection of cursor type from Marker, Horiz, Vertical, H&V, Degree, and Vertical History.
Automatic Measurement of Waveform Parameters Function	Capable of performing automated measurement of waveform parameters. Automated measurement of waveform parameters within one period (P-P through Int2XY), statistical processing of waveform parameters, and statistical processing on the waveform parameters of historical data. P-P, Max, Min, Ave, Rms, Sdev, High, Low, +OShot, -OShot, Int1TY, Int2TY, Int1XY, Int2XY, Freq, Period, Rise, Fall, +Width, -Width, Duty, Burst1, Burst2, Pulse, AvgFreq, AvgPeriod, and Delay (between channels). Statistical processing results. Statistics: Min, Max, Avg, Cnt, and Sdv. Waveform parameter computation. Operation between waveform parameters and constants. Operators are +, -, *, and /. Measure waveform parameters in different areas on the same channel.
Computing Functions	+ , - , χ , power spectrum However, select the number of point for the power spectrum (1 kword or 10 kwords).
Phase Shift	The phase of CH1 to CH4 (or CH1 to CH2 for the DL1620) can be shifted for monitoring. Computation is performed using the phase-shifted result.
GO/NO-GO Function	Judgment is made on the automatically measured value of waveform parameters and the results are output to the printer or to a storage medium, buzzer, or send a mail. ^{*1}

^{*1} This function can be used when the Ethernet interface (option) is installed.

16.5 Functions/16.6 Built-in Printer (Option)

Screen Data Output

Item	Specifications
Built-in Printer (Option)	Outputs hard copy of screen.
External Printer	Print the screen image to an external parallel printer (through the USB PERIPHERAL terminal or Ethernet ^{*1}). Supports ESC/P, ESC/P2, LIPS3, PCL5, BJ commands, and PostScript (Ethernet interface option ^{*1}).
Floppy Disk ^{*2} /Zip Disk ^{*2} / PC Card ^{*2} /Internal Flash Memory/ Network Drive ^{*1} /USB Storage	Output data formats: PostScript, TIFF, BMP, PNG, JPEG

*1 This function can be used when the Ethernet interface (option) is installed.

*2 Any of the built-in drives (floppy disk drive, Zip drive, or PC card drive) can be selected.

Data Storage

Item	Specifications
History Memory	DL1620/DL1640: Retains max. 4000 waveforms recorded. DL1640L: Retains max. 16000 waveforms recorded.
Floppy Disk ^{*2} /Zip Disk ^{*2} / PC Card ^{*2} /Internal Flash Memory/ Network Drive ^{*1} /USB Storage	Save and restore waveform data, settings, other data.

*1 This function can be used when the Ethernet interface (option) is installed.

*2 Any of the built-in drives (floppy disk drive, Zip drive, or PC card drive) can be selected.

Other Functions

Item	Specifications
Initialization Function	Automatically resets key settings to the factory settings. (Excludes date/time settings, settings related to the communication interface, settings stored to the internal memory using the store/recall function, and setting the message language.)
Auto setup Function	Automatically sets key settings to the optimum values for the input signals.
Store/Recall	Store and recall up to three arbitrary settings.
Preset Function	Presets for the CMOS (5 V), CMOS (3.3 V), and user settings.
Action on Trigger	Hard Copy, Save to File, Buzzer and Send Mail are performed every time a trigger is activated.
Send Mail ^{*1}	Sending mails for DL1620/DL1640/DL1640L condition via the Ethernet interface.
Calibration	Auto calibration and manual calibration are possible.
Environment Setting Function	Allows setting of screen color, date/time, message language, click sound ON/OFF.
Probe Compensation Signal Output Function	Outputs a square calibration waveform signal (approx. 1 V _{P-P} , approx. 1 kHz) from the probe compensation signal output terminal on the front panel.
Overview Function	Shows system configuration.
Self Test Function	Allows memory test, key test, printer test, FD drive test, Zip drive test, PC card drive test, or an accuracy test.
Help Function	Displays help about settings.
Thumbnail	Displays the thumbnail preview window containing screen image files.

*1 This function can be used when the Ethernet interface (option) is installed.

16.6 Built-in Printer (Option)

Item	Specifications
Printing System	Thermal line dot method
Dot Density	8 dots/mm
Paper Width	112 mm

16.7 Storage

Built-in Storage

• Floppy Disk Drive

Item	Specifications
No. of Drives	1
Drive Size	3.5 inches
Capacity	720 KB, 1.44 MB

• Zip Drive

Item	Specifications
No. of Drives	1
Capacity	100 MB, 250 MB

• PC Card Interface

Item	Specifications
No. of Slots	1
Compatible Cards	Flash ATA card (PC card TYPE II)

• Internal Flash Memory

Item	Specifications
No. of Drives	1
Capacity	2 MB
No. of Rewrites	Less than approximately 100000

USB Storage (Option)*

Item	Specifications
Supports USB Mass Storage	USB mass storage class hard disk drive, MO disk drive, and flash memory.

* For details on the interface specifications, see section 16.8.

16.8 USB PERIPHERAL Interfaces (Option)

Item	Specification
Connector Type	Type A connector (receptacle)
Electrical and Mechanical Specifications	Conforms to USB Rev.1.1
Data Rate	12 Mbps max.
Supported Keyboards	104 keyboard (US) and 109 keyboard (Japanese) that conform to USB HID Class Ver.1.1
Supported Printers	ESC/P, ESC/P2, LIPS3, PCL5, and BJ (can be used on models that support the BJC-35V native commands) that support USB (USB Printer Class Ver.1.0)
Supported Mouses	Mouse that conforms to USB HID Class Ver. 1.1
Supports USB Mass Storage	USB mass storage class hard disk drive, MO disk drive, and flash memory
Power Supply	5 V, 500 mA* (per port)
Number of Ports	2

* Devices with maximum consumption currents exceeding 100 mA cannot be connected to two ports at the same time.

16.9 Auxiliary Input/Output Section

External Trigger Input^{*1}

Item	Specifications
Connector Type	BNC
Input Bandwidth	External Trigger Input : DC to 100 MHz
Input Impedance	Approx. 1 M Ω , 28 pF
Maximum Input Voltage	± 40 V (DC + AC peak) or 28 V _{rms} , 10 kHz or less
Trigger Level	± 2 V (5 mV measurement resolution) for the DL1640/DL1640L ± 1 V (5 mV measurement resolution) for the DL1620 with the ± 1 V range selected ± 10 V (50 mV measurement resolution) for the DL1620 with the ± 10 V range selected

*1 The EXT TRIG IN terminal also operates as an EXT CLOCK IN terminal. Specifications for external clock input appear in section 16.3. This terminal is labeled "EXT CLOCK IN/EXT TRIG IN" on the DL1640/DL1640L or "EXT." on the DL1620

Trigger Output (TRIG OUT)

Item	Specifications
Connector Type	BNC
Output Level	TTL
Output Logic	Negative logic
Output Delay Time	50 ns max.
Output Hold Time	1 μ s min. for low level, 100 ns min. for high level

RGB Video Signal Output (RGB VIDEO OUT)

Item	Specifications
Connector Type	D-Sub 15-pin socket
Output Type	VGA compatible

GO/NO-GO Input/Output (NO-GO OUT, GO OUT)

Item	Specifications
Connector Type	RJ-11 modular jack
Input/Output Level	START-IN input : TTL (0-5 V), switch input possible GO-OUT/NOGO-OUT output : CMOS (0-5 V)
Signal	START-IN, NOGO-OUT, GO-OUT
Cable	Four-wire modular cable

Power Connectors for the Probes (Option)

Item	Specifications
Number of Output	4
Output Voltage	± 12 V (Up to ± 450 mA)
Usable Probe	Current probe (700937, 701930, 701931, 701932, 701933) Differential probe (700924 ^{*1} , 700925 ^{*1} , 901921, 701922 ^{*2})

*1 A probe power cable (B9852MJ) is required to supply power from the DL1620/DL1640/DL1640L.

*2 A 50- Ω terminator is required to connect the differential probe to the DL1620/DL1640/DL1640L.

CH1 OUT Signal

Item	Specifications
Connector Type	BNC
Output Level	20 mV/div $\pm 30\%$ (50 Ω termination)
Frequency Range	DC to 20 MHz (-3 dB attenuation point)

16.10 Computer Interface

GP-IB (Option)

Item	Specifications
Electrical and Mechanical Specifications	Conforms to IEEE St'd 488-1978 (JIS C 1901-1987).
Interface Functions	SH1, AH1, T6, L4, SR1, RL1, PP0, DC1, DT0, C0
Protocol	Conforms to IEEE St'd 488.2-1992.
Code	ISO (ASCII) code
Mode	Addressable mode
Address Setting	Listener and talker addresses 0 to 30 are settable.
Remote Mode Clear	Remote mode can be cleared by pressing the SHIFT key + the CLEAR TRACE key (except when local lockout has been set).

For details refer to the Communication Interface User's Manual (IM701610-17E).

Serial (RS-232, Standard)

Item	Specifications
Connector Type	Half pitch interface cable (D-Sub 9-pin plug)
Electrical Specifications	Conforms to EIA 574 Standard (EIA-232 (RS-232) Standard for 9-pin)
Connection Format	Point to point
Communication Format	Full duplex
Synchronizing Format	Start-stop asynchronous transmission
Baud Rate	1200, 2400, 4800, 9600, 19200, 38400, 57600

For details refer to the Communication Interface User's manual (IM701610-17E).

USB (Option)

Item	Specifications
Connector	Type B connector (receptacle)
Electrical and Mechanical Specifications	Conforms to USB Rev.1.1
Speed	Max. 12 Mbps
Number of Ports	1
Supported Systems	Models with standard USB ports that run Windows 98 SE, Windows Me, Windows 2000, or Windows XP. (A separate device driver is required for connecting to a PC.)

Ethernet (Option)

Item	Specifications
Communication Port Number	1
Electrical-Mechanical Specifications	IEEE 802.3 standards
Transmission Method	Ethernet (100BASE-TX, 10BASE-T)
Transmission Rate	Max. 100 Mbps
Communication Protocol	TCP/IP
Supported Services	FTP server, FTP client (network drive), LPR client (network printer), SMTP client (mail transmission), Web server, DHCP, DNS, SNTP, Web DAV.
Connector Type	RJ-45 connector

16.11 General

Item	Specifications
Standard Operating Conditions	Ambient Temperature : 23 ±5°C Ambient Humidity : 55 ±10% RH Power Voltage and Frequency : Less than 1% of the rated voltage/frequency fluctuation
Warm-up Time	30 min. or more
Storage Conditions	Temperature : -20 to 60°C, -20 to 50°C (-J2 (built-in Zip drive) model) Humidity : 20 to 80% RH (no condensation allowed)
Operating Conditions	Temperature : 5 to 40°C Humidity : 20 to 80% RH (without a printer) 35 to 80% RH (with a printer)
Storage Altitude	3000 m or below
Operating Altitude	2000 m or below
Rated Supply Voltage	"-AC" model: 100 to 120 VAC, 220 to 240 VAC "-DC" model: 12 VDC
Permissible Supply Voltage Range	"-AC" model: 90 to 132 VAC, 198 to 264 VAC "-DC" model: 10 to 18 VDC
Rated Supply Voltage Frequency	50Hz, 60 Hz
Permissible Supply Voltage Frequency	48 to 63 Hz
Fuse	Internal Replacement not possible.
Maximum Power Consumption	"-AC" model: 100 VA (when the built-in printer is used) "-DC" model: 60 VA (when the built-in printer is used)
Withstand Voltage (between power supply and case)	1.5 kVAC for 1 minute
Insulation Resistance (between power supply and case)	10 MΩ or more at 500 VDC
External Dimensions (details on page 16-11)	220 (W) × 266 (H) × 224 (D) mm (with printer cover closed, projections excluded)
Weight	Approx. 3.9 kg (options excluded)
Cooling Method	Forced air cooling, air discharged from rear
Installation Position	Horizontally (the stand can be used), vertically (cannot use the Zip drive), and no stacking.
Battery Backup	Setup data and internal clock are backed up by a built-in lithium battery. Battery life: approx. 5 years (at ambient temperature of 23°C)
Accessories	<ul style="list-style-type: none"> • 1 power cord (Only on models with "-AC" suffix) • 1 DC power connector (Only on models with "-DC" suffix) • 200 MHz passive probes (4) • 1 roll of printer paper (Only on models with "/B5" suffix) • 4 rubber pads for bottom legs : B9989EX • Front cover stickers (4) : B9989FA • User's Manual (this manual) • Operation Guide • Communication Interface Manual (CD-ROM) • I²C-Bus Signal Analysis Function User's Manual (Only on models with "/F5" suffix) • CAN Bus Signal Analysis Function User's Manual (Only on models with "/F7" suffix)

Item	Specifications
Safety standard	<p>Complying standard EN61010-1</p> <ul style="list-style-type: none"> • Input terminal: Overvoltage category(Installation category) I*1 • Pollution degree 2*2
Emission	<p>Complying standard</p> <ul style="list-style-type: none"> • EN61326-1 Class A • EN61326-2-1 • EN55011 Class A, Group 1 • C-tick EN55011 Class A, Group 1 (apply for 701605, 701610, 701620, 700960, 700937, 701930) • EN61000-3-2 • EN61000-3-3 <p>This product is a Class A (for industrial environment) product. Operation of this product in a domestic environment may cause radio interference in which case the user is required to correct the interference.</p> <p>Cable requirement</p> <ul style="list-style-type: none"> • External trigger/ External clock input terminal Use a BNC cable*3. Attach a ferrite core (TDK: ZCAT2035-0930A, YOKOGAWA: A1190MN) to the end of the cable on the instrument side. • Trigger output terminal Same as the above external trigger input terminal. • CH1 OUT connector Same as the above external trigger input terminal. • RGB VIDEO OUT terminal Use a D-Sub 15-pin VGA shielded cable*3. • Serial(RS-232)interface connector Use an RS-232 shielded cable*3 and attach a ferrite core (TDK: ZCAT2035-0930A, YOKOGAWA: A1190MN)to the end of the cable on the instrument side. • USB PERIPHERAL connector Use a USB cable*3. Attach a ferrite core (TDK: ZCAT1325-0530A, YOKOGAWA: A1181MN) to the end of the cable on the instrument side. • USB interface connector Use a USB cable*3. Attach a ferrite core (TDK: ZCAT1325-0530A, YOKOGAWA: A1181MN) to the end of the cable on the instrument side. • GO/NO-GO output terminal Use a GO/NOGO cable (YOKOGAWA model 366973, sold separately). Attach a ferrite core (TDK: ZCAT1325-0530A, YOKOGAWA: A1181MN) to the end of the cable on the instrument side. • Ethernet connector Use a Ethernet cable*3. Attach a ferrite core (TDK: ZCAT1325-0530A, YOKOGAWA: A1181MN) to the end of the cable on the instrument side. • Power connectors for the probes Attach a ferrite core (TDK: ZCAT1325-0530A, YOKOGAWA: A1181MN) to the end of the cable on the instrument side.
Immunity*1	<p>Complying standard EN61326-1 Table 2 (for use in industrial locations)</p> <p>EN61326-2-1 (apply for 701605, 701610, 701620, 700960, 700937, 701930)</p> <p>Influence in the immunity environment</p> <ul style="list-style-type: none"> • Noise increase <ul style="list-style-type: none"> · $\leq \pm 80$ mV, when using 700960 · $\leq \pm 400$ mA, when using 700937 · $\leq \pm 4$ A, when using 701930 • Test condition <ul style="list-style-type: none"> When using 700960 200 MS/s, envelope mode, 20 MHz BWL, 20 mV/div (probe attenuation setting: 10:1), terminate the probe at 50 MΩ. When using 700937 200 MS/s, envelope mode, 20 MHz BWL, 0.1 A/div (probe setting: 700937). Attach a ferrite core (TDK: ZCAT2035-0930A, YOKOGAWA: A1190MN) to each end of the signal cable. When using 701930 200 MS/s, envelope mode, 20 MHz BWL, 1 A/div (probe setting: 701930). Attach a ferrite core (TDK: ZCAT2035-0930A, YOKOGAWA: A1190MN) to each end of the signal cable. • Cable requirement Same requirement as above for emission.

*1 The instrument's expected overvoltage is 1500 V. To prevent fire or electric shock, do not use this instrument for category II, III, or IV measurements.

*2 "Pollution degree" describes the degree to which a solid, liquid, or gas which deteriorates dielectric strength or surface resistivity is adhering. "2" applies to normal indoor atmosphere. Normally, only non-conductive pollution occurs.

*3 The cable length is less than 3 m.

Applies to products manufactured after August 2002 having the CE Mark. For all other products, please contact your nearest YOKOGAWA representative.

16.12 External Dimensions

Dimensions: mm

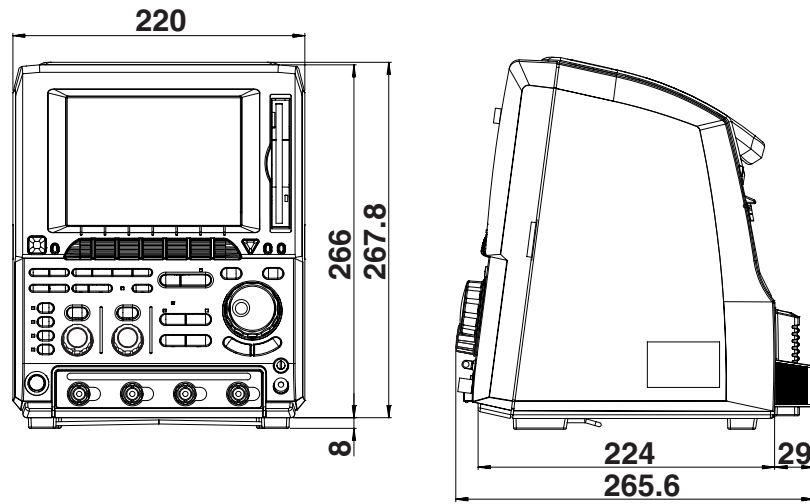

Unless otherwise specified, tolerance is $\pm 3\%$.

(Tolerance is always ± 0.3 mm when the dimension is under 10 mm.)

Appendix 1 Relationship between the Time Axis Setting, Sample Rate and Record Length

DL1620/DL1640

Record length: 1 kword

When envelope mode is ON, set at 200 MS/s (When the high-resolution mode is ON, 100 M/s)

Rep: Repetitive sampling mode

Setting T/div	When a mode other than the envelope mode is ON							
	Standard resolution				High resolution			
	Rep: OFF		Rep: ON		Rep: OFF		Rep: ON	
	Sample rate (S/s)	Displayed record length (words)	Sample rate (S/s)	Displayed record length (words)	Sample rate (S/s)	Displayed record length (words)	Sample rate (S/s)	Displayed record length (words)
500s	–	–	–	–	–	–	–	–
200s	–	–	–	–	–	–	–	–
100s	–	–	–	–	–	–	–	–
50 s	–	–	–	–	–	–	–	–
20 s	–	–	–	–	–	–	–	–
10 s	–	–	–	–	–	–	–	–
5 s	20	1 k	20	1 k	20	1 k	20	1 k
2 s	50	1 k	50	1 k	50	1 k	50	1 k
1 s	100	1 k	100	1 k	100	1 k	100	1 k
500 ms	200	1 k	200	1 k	200	1 k	200	1 k
200 ms	500	1 k	500	1 k	500	1 k	500	1 k
100 ms	1 k	1 k	1 k	1 k	1 k	1 k	1 k	1 k
50 ms	2 k	1 k	2 k	1 k	2 k	1 k	2 k	1 k
20 ms	5 k	1 k	5 k	1 k	5 k	1 k	5 k	1 k
10 ms	10 k	1 k	10 k	1 k	10 k	1 k	10 k	1 k
5 ms	20 k	1 k	20 k	1 k	20 k	1 k	20 k	1 k
2 ms	50 k	1 k	50 k	1 k	50 k	1 k	50 k	1 k
1 ms	100 k	1 k	100 k	1 k	100 k	1 k	100 k	1 k
500 μs	200 k	1 k	200 k	1 k	200 k	1 k	200 k	1 k
200 μs	500 k	1 k	500 k	1 k	500 k	1 k	500 k	1 k
100 μs	1 M	1 k	1 M	1 k	1 M	1 k	1 M	1 k
50 μs	2 M	1 k	2 M	1 k	2 M	1 k	2 M	1 k
20 μs	5 M	1 k	5 M	1 k	5 M	1 k	5 M	1 k
10 μs	10 M	1 k	10 M	1 k	10 M	1 k	10 M	1 k
5 μs	20 M	1 k	20 M	1 k	20 M	1 k	20 M	1 k
2 μs	50 M	1 k	50 M	1 k	50 M	1 k	50 M	1 k
1 μs	100 M	1 k	100 M	1 k	100 M	1 k	100 M	1 k
500 ns	200 M	1 k	200 M	1 k	100 M	500	200 M	1 k
200 ns	200 M	400	500 M	1 k	100 M	200	500 M	1 k
100 ns	200 M	200	1 G	1 k	100 M	100	1 G	1 k
50 ns	200M	100	2 G	1 k	2 G	1 k	2 G	1 k
20 ns	5 G	1 k	5 G	1 k	5 G	1 k	5 G	1 k
10 ns	10 G	1 k	10 G	1 k	10 G	1 k	10 G	1 k
5 ns	20 G	1 k	20 G	1 k	20 G	1 k	20 G	1 k
2 ns	50 G	1 k	50 G	1 k	50 G	1 k	50 G	1 k

*1 When the envelope mode is ON, the maximum and minimum are displayed as pairs.

*2 For the settings enclosed by the bold lines, repetitive sampling is active.

Appendix 1 Relationship between the Time Axis Setting, Sample Rate and Record Length

Record length: 10 kwords

When envelope mode is ON, set at 200 MS/s (When the high-resolution mode is ON, 100 M/s)

Rep: Repetitive sampling mode

Setting T/div	When a mode other than the envelope mode is ON							
	Standard resolution				High resolution			
	Rep: OFF		Rep: ON		Rep: OFF		Rep: ON	
	Sample rate (S/s)	Displayed record length (words)	Sample rate (S/s)	Displayed record length (words)	Sample rate (S/s)	Displayed record length (words)	Sample rate (S/s)	Displayed record length (words)
500s	–	–	–	–	–	–	–	–
200s	–	–	–	–	–	–	–	–
100s	–	–	–	–	–	–	–	–
50s	20	10k	20	10k	20	10k	20	10k
20s	50	10k	50	10k	50	10k	50	10k
10s	100	10k	100	10k	100	10k	100	10k
5s	200	10k	200	10k	200	10k	200	10k
2s	500	10k	500	10k	500	10k	500	10k
1s	1k	10k	1k	10k	1k	10k	1k	10k
500ms	2k	10k	2k	10k	2k	10k	2k	10k
200ms	5k	10k	5k	10k	5k	10k	5k	10k
100ms	10k	10k	10k	10k	10k	10k	10k	10k
50ms	20k	10k	20k	10k	20k	10k	20k	10k
20ms	50k	10k	50k	10k	50k	10k	50k	10k
10ms	100k	10k	100k	10k	100k	10k	100k	10k
5ms	200k	10k	200k	10k	200k	10k	200k	10k
2ms	500k	10k	500k	10k	500k	10k	500k	10k
1ms	1M	10k	1M	10k	1M	10k	1M	10k
500µs	2M	10k	2M	10k	2M	10k	2M	10k
200µs	5M	10k	5M	10k	5M	10k	5M	10k
100µs	10M	10k	10M	10k	10M	10k	10M	10k
50µs	20M	10k	20M	10k	20M	10k	20M	10k
20µs	50M	10k	50M	10k	50M	10k	50M	10k
10µs	100M	10k	100M	10k	100M	10k	100M	10k
5µs	200M	10k	200M	10k	100M	5k	200M	10k
2µs	200M	4k	500M	10k	100M	2k	500M	10k
1µs	200M	2k	1G	10k	100M	1k	1G	10k
500ns	200M	1k	2G	10k	100M	500	2G	10k
200ns	200M	400	5G	10k	100M	200	5G	10k
100ns	200M	200	10G	10k	100M	100	10G	10k
50ns	200M	100	20G	10k	20G	10k	20G	10k
20ns	50G	10k	50G	10k	50G	10k	50G	10k
10ns	50G	5k	50G	5k	50G	5k	50G	5k
5ns	50G	2.5k	50G	2.5k	50G	2.5k	50G	2.5k
2ns	50G	1k	50G	1k	50G	1k	50G	1k

*1 When the envelope mode is ON, the maximum and minimum are displayed as pairs.

*2 For the settings enclosed by the bold lines, repetitive sampling is active.

Appendix 1 Relationship between the Time Axis Setting, Sample Rate and Record Length

Record length: 100 kwords

When envelope mode is ON, set at 200 MS/s (When the high-resolution mode is ON, 100 M/s)

Rep: Repetitive sampling mode

Setting T/div	When a mode other than the envelope mode is ON							
	Standard resolution				High resolution			
	Rep: OFF		Rep: ON		Rep: OFF		Rep: ON	
	Sample rate (S/s)	Displayed record length (words)	Sample rate (S/s)	Displayed record length (words)	Sample rate (S/s)	Displayed record length (words)	Sample rate (S/s)	Displayed record length (words)
500s	20	100k	20	100k	20	100k	20	100k
200s	50	100k	50	100k	50	100k	50	100k
100s	100	100k	100	100k	100	100k	100	100k
50 s	200	100k	200	100k	200	100k	200	100k
20 s	500	100k	500	100k	500	100k	500	100k
10 s	1k	100k	1k	100k	1k	100k	1k	100k
5 s	2k	100k	2k	100k	2k	100k	2k	100k
2 s	5k	100k	5k	100k	5k	100k	5k	100k
1 s	10k	100k	10k	100k	10k	100k	10k	100k
500 ms	20k	100k	20k	100k	20k	100k	20k	100k
200 ms	50k	100k	50k	100k	50k	100k	50k	100k
100 ms	100k	100k	100k	100k	100k	100k	100k	100k
50 ms	200k	100k	200k	100k	200k	100k	200k	100k
20 ms	500k	100k	500k	100k	500k	100k	500k	100k
10 ms	1M	100k	1M	100k	1M	100k	1M	100k
5 ms	2M	100k	2M	100k	2M	100k	2M	100k
2 ms	5M	100k	5M	100k	5M	100k	5M	100k
1 ms	10M	100k	10M	100k	10M	100k	10M	100k
500 μs	20M	100k	20M	100k	20M	100k	20M	100k
200 μs	50M	100k	50M	100k	50M	100k	50M	100k
100 μs	100M	100k	100M	100k	100M	100k	100M	100k
50 μs	200M	100k	200M	100k	100M	50k	200M	100k
20 μs	200M	40k	500M	100k	100M	20k	500M	100k
10 μs	200M	20k	1G	100k	100M	10k	1G	100k
5 μs	200M	10k	2G	100k	100M	5k	2G	100k
2 μs	200M	4k	5G	100k	100M	2k	5G	100k
1 μs	200M	2k	10G	100k	100M	1k	10G	100k
500 ns	200M	1k	20G	100k	100M	500	20G	100k
200 ns	200M	400	50G	100k	100M	200	50G	100k
100 ns	200M	200	50G	50k	100M	100	50G	50k
50 ns	200M	100	50G	25k	50G	25k	50G	25k
20 ns	50G	10k	50G	10k	50G	10k	50G	10k
10 ns	50G	5k	50G	5k	50G	5k	50G	5k
5 ns	50G	2.5k	50G	2.5k	50G	2.5k	50G	2.5k
2 ns	50G	1k	50G	1k	50G	1k	50G	1k

*1 When the envelope mode is ON, the maximum and minimum are displayed as pairs.

*2 For the settings enclosed by the bold lines, repetitive sampling is active.

Appendix 1 Relationship between the Time Axis Setting, Sample Rate and Record Length

Record length: 1 Mword

When envelope mode is ON, set at 200 MS/s (When the high-resolution mode is ON, 100 M/s)

Rep: Repetitive sampling mode

Setting T/div	When a mode other than the envelope mode is ON							
	Standard resolution				High resolution			
	Rep: OFF		Rep: ON		Rep: OFF		Rep: ON	
	Sample rate (S/s)	Displayed record length (words)	Sample rate (S/s)	Displayed record length (words)	Sample rate (S/s)	Displayed record length (words)	Sample rate (S/s)	Displayed record length (words)
500s	200	1M	200	1M	200	1M	200	1M
200s	500	1M	500	1M	500	1M	500	1M
100s	1k	1M	1k	1M	1k	1M	1k	1M
50 s	2k	1M	2k	1M	2k	1M	2k	1M
20 s	5k	1M	5k	1M	5k	1M	5k	1M
10 s	10k	1M	10k	1M	10k	1M	10k	1M
5 s	20k	1M	20k	1M	20k	1M	20k	1M
2 s	50k	1M	50k	1M	50k	1M	50k	1M
1 s	100k	1M	100k	1M	100k	1M	100k	1M
500 ms	200k	1M	200k	1M	200k	1M	200k	1M
200 ms	500k	1M	500k	1M	500k	1M	500k	1M
100 ms	1M	1M	1M	1M	1M	1M	1M	1M
50 ms	2M	1M	2M	1M	2M	1M	2M	1M
20 ms	5M	1M	5M	1M	5M	1M	5M	1M
10 ms	10M	1M	10M	1M	10M	1M	10M	1M
5 ms	20M	1M	20M	1M	20M	1M	20M	1M
2 ms	50M	1M	50M	1M	50M	1M	50M	1M
1 ms	100M	1M	100M	1M	100M	1M	100M	1M
500 μs	200M	1M	200M	1M	100M	500k	100M	500k
200 μs	200M	400k	200M	400k	100M	200k	100M	200k
100 μs	200M	200k	200M	200k	100M	100k	100M	100k
50 μs	200M	100k	200M	100k	100M	50k	200M	100k
20 μs	200M	40k	500M	100k	100M	20k	500M	100k
10 μs	200M	20k	1G	100k	100M	10k	1G	100k
5 μs	200M	10k	2G	100k	100M	5k	2G	100k
2 μs	200M	4k	5G	100k	100M	2k	5G	100k
1 μs	200M	2k	10G	100k	100M	1k	10G	100k
500 ns	200M	1k	20G	100k	100M	500	20G	100k
200 ns	200M	400	50G	100k	100M	200	50G	100k
100 ns	200M	200	50G	50k	100M	100	50G	50k
50 ns	200M	100	50G	25k	50G	20k	50G	25k
20 ns	50G	10k	50G	10k	50G	10k	50G	10k
10 ns	50G	5k	50G	5k	50G	5k	50G	5k
5 ns	50G	2.5k	50G	2.5k	50G	2.5k	50G	2.5k
2 ns	50G	1k	50G	1k	50G	1k	50G	1k

*1 When the envelope mode is ON, the maximum and minimum are displayed as pairs.

*2 For the settings enclosed by the bold lines, repetitive sampling is active.

Appendix 1 Relationship between the Time Axis Setting, Sample Rate and Record Length

Record length: 8 Mwords (When the high-resolution mode is ON, 4 Mwords)

When envelope mode is ON, set at 200 MS/s (When the high-resolution mode is ON, 100 M/s)

Rep: Repetitive sampling mode

Setting T/div	When a mode other than the envelope mode is ON							
	Standard resolution				High resolution			
	Rep: OFF		Rep: ON		Rep: OFF		Rep: ON	
	Sample rate (S/s)	Displayed record length (words)	Sample rate (S/s)	Displayed record length (words)	Sample rate (S/s)	Displayed record length (words)	Sample rate (S/s)	Displayed record length (words)
(800 s)	1k	8M	1k	8M	500	4M	500	4M
500 s	1k	5M	1k	5M	500	2.5M	500	2.5M
(400 s)	2k	8M	2k	8M	1k	4M	1k	4M
200 s	2k	4M	2k	4M	2k	4M	2k	4M
(160 s)	5k	8M	5k	8M	–	–	–	–
100 s	5k	5M	5k	5M	2k	2M	2k	2M
(80 s)	10k	8M	10k	8M	5k	4M	5k	4M
50 s	10k	5M	10k	5M	5k	2.5M	5k	2.5M
(40 s)	20k	8M	20k	8M	10k	4M	10k	4M
20 s	20k	4M	20k	4M	20k	4M	20k	4M
(16 s)	50k	8M	50k	8M	–	–	–	–
10 s	50k	5M	50k	5M	20k	2M	20k	2M
(8 s)	100k	8M	100k	8M	50k	4M	50k	4M
5 s	100k	5M	100k	5M	50k	2.5M	50k	2.5M
(4 s)	200k	8M	200k	8M	100k	4M	100k	4M
2 s	200k	4M	200k	4M	200k	4M	200k	4M
(1.6 s)	500k	8M	500k	8M	–	–	–	–
1 s	500k	5M	500k	5M	200k	2M	200k	2M
(800 ms)	1M	8M	1M	8M	500k	4M	500k	4M
500 ms	1M	5M	1M	5M	500k	2.5M	500k	2.5M
(400 ms)	2M	8M	2M	8M	1M	4M	1M	4M
200 ms	2M	4M	2M	4M	2M	4M	2M	4M
(160 ms)	5M	8M	5M	8M	–	–	–	–
100 ms	5M	5M	5M	5M	2M	2M	2M	2M
(80 ms)	10M	8M	10M	8M	5M	4M	5M	4M
50 ms	10M	5M	10M	5M	5M	2.5M	5M	2.5M
(40 ms)	20M	8M	20M	8M	10M	4M	10M	4M
20 ms	20M	4M	20M	4M	20M	4M	20M	4M
(16 ms)	50M	8M	50M	8M	–	–	–	–
10 ms	50M	5M	50M	5M	20M	2M	20M	2M
(8 ms)	100M	8M	100M	8M	50M	4M	50M	4M
5 ms	100M	5M	100M	5M	50M	2.5M	50M	2.5M
(4 ms)	200M	8M	200M	8M	100M	4M	100M	4M
2 ms	200M	4M	200M	4M	100M	2M	100M	2M
1 ms	200M	2M	200M	2M	100M	1M	100M	1M
500 μs	200M	1M	200M	1M	100M	500k	100M	500k
200 μs	200M	400k	200M	400k	100M	200k	100M	200k
100 μs	200M	200k	200M	200k	100M	100k	100M	100k
50 μs	200M	100k	200M	100k	100M	50k	200M	100k
20 μs	200M	50k	500M	100k	100M	20k	500M	100k
10 μs	200M	20k	1G	100k	100M	10k	1G	100k
5 μs	200M	10k	2G	100k	100M	5k	2G	100k
2 μs	200M	5k	5G	100k	100M	2k	5G	100k
1 μs	200M	2k	10G	100k	100M	1k	10G	100k
500 ns	200M	1k	20G	100k	100M	500	20G	100k
200 ns	200M	500	50G	100k	100M	200	50G	100k
100 ns	200M	200	50G	50k	100M	100	50G	50k
50 ns	200M	100	50G	25k	50G	25k	50G	25k
20 ns	50G	10k	50G	10k	50G	10k	50G	10k
10 ns	50G	5k	50G	5k	50G	5k	50G	5k
5 ns	50G	2.5k	50G	2.5k	50G	2.5k	50G	2.5k
2 ns	50G	1k	50G	1k	50G	1k	50G	1k

*1 When the envelope mode is ON, the maximum and minimum are displayed as pairs.

*2 For the settings enclosed by the bold lines, repetitive sampling is active.

Appendix 1 Relationship between the Time Axis Setting, Sample Rate and Record Length

DL1640L

Record length: 1 kword

When envelope mode is ON, set at 200 MS/s (When the high-resolution mode is ON, 100 M/s)

Rep: Repetitive sampling mode

Setting T/div	When a mode other than the envelope mode is ON							
	Standard resolution				High resolution			
	Rep: OFF		Rep: ON		Rep: OFF		Rep: ON	
	Sample rate (S/s)	Displayed record length (words)	Sample rate (S/s)	Displayed record length (words)	Sample rate (S/s)	Displayed record length (words)	Sample rate (S/s)	Displayed record length (words)
500s	–	–	–	–	–	–	–	–
200s	–	–	–	–	–	–	–	–
100s	–	–	–	–	–	–	–	–
50s	–	–	–	–	–	–	–	–
20s	–	–	–	–	–	–	–	–
10s	–	–	–	–	–	–	–	–
5s	20	1k	20	1k	20	1k	20	1k
2s	50	1k	50	1k	50	1k	50	1k
1s	100	1k	100	1k	100	1k	100	1k
500ms	200	1k	200	1k	200	1k	200	1k
200ms	500	1k	500	1k	500	1k	500	1k
100ms	1k	1k	1k	1k	1k	1k	1k	1k
50ms	2k	1k	2k	1k	2k	1k	2k	1k
20ms	5k	1k	5k	1k	5k	1k	5k	1k
10ms	10k	1k	10k	1k	10k	1k	10k	1k
5ms	20k	1k	20k	1k	20k	1k	20k	1k
2ms	50k	1k	50k	1k	50k	1k	50k	1k
1ms	100k	1k	100k	1k	100k	1k	100k	1k
500µs	200k	1k	200k	1k	200k	1k	200k	1k
200µs	500k	1k	500k	1k	500k	1k	500k	1k
100µs	1M	1k	1M	1k	1M	1k	1M	1k
50µs	2M	1k	2M	1k	2M	1k	2M	1k
20µs	5M	1k	5M	1k	5M	1k	5M	1k
10µs	10M	1k	10M	1k	10M	1k	10M	1k
5µs	20M	1k	20M	1k	20M	1k	20M	1k
2µs	50M	1k	50M	1k	50M	1k	50M	1k
1µs	100M	1k	100M	1k	100M	1k	100M	1k
500ns	200M	1k	200M	1k	100M	500	200M	1k
200ns	200M	400	500M	1k	100M	200	500M	1k
100ns	200M	200	1G	1k	100M	100	1G	1k
50ns	200M	100	2G	1k	2G	1k	2G	1k
20ns	5G	1k	5G	1k	5G	1k	5G	1k
10ns	10G	1k	10G	1k	10G	1k	10G	1k
5ns	20G	1k	20G	1k	20G	1k	20G	1k
2ns	50G	1k	50G	1k	50G	1k	50G	1k

*1 When the envelope mode is ON, the maximum and minimum are displayed as pairs.

*2 For the settings enclosed by the bold lines, repetitive sampling is active.

Appendix 1 Relationship between the Time Axis Setting, Sample Rate and Record Length

Record length: 10 kwords

When envelope mode is ON, set at 200 MS/s (When the high-resolution mode is ON, 100 M/s)

Rep: Repetitive sampling mode

Setting T/div	When a mode other than the envelope mode is ON							
	Standard resolution				High resolution			
	Rep: OFF		Rep: ON		Rep: OFF		Rep: ON	
	Sample rate (S/s)	Displayed record length (words)	Sample rate (S/s)	Displayed record length (words)	Sample rate (S/s)	Displayed record length (words)	Sample rate (S/s)	Displayed record length (words)
500s	–	–	–	–	–	–	–	–
200s	–	–	–	–	–	–	–	–
100s	–	–	–	–	–	–	–	–
50s	20	10k	20	10k	20	10k	20	10k
20s	50	10k	50	10k	50	10k	50	10k
10s	100	10k	100	10k	100	10k	100	10k
5s	200	10k	200	10k	200	10k	200	10k
2s	500	10k	500	10k	500	10k	500	10k
1s	1k	10k	1k	10k	1k	10k	1k	10k
500ms	2k	10k	2k	10k	2k	10k	2k	10k
200ms	5k	10k	5k	10k	5k	10k	5k	10k
100ms	10k	10k	10k	10k	10k	10k	10k	10k
50ms	20k	10k	20k	10k	20k	10k	20k	10k
20ms	50k	10k	50k	10k	50k	10k	50k	10k
10ms	100k	10k	100k	10k	100k	10k	100k	10k
5ms	200k	10k	200k	10k	200k	10k	200k	10k
2ms	500k	10k	500k	10k	500k	10k	500k	10k
1ms	1M	10k	1M	10k	1M	10k	1M	10k
500µs	2M	10k	2M	10k	2M	10k	2M	10k
200µs	5M	10k	5M	10k	5M	10k	5M	10k
100µs	10M	10k	10M	10k	10M	10k	10M	10k
50µs	20M	10k	20M	10k	20M	10k	20M	10k
20µs	50M	10k	50M	10k	50M	10k	50M	10k
10µs	100M	10k	100M	10k	100M	10k	100M	10k
5µs	200M	10k	200M	10k	100M	5k	200M	10k
2µs	200M	4k	500M	10k	100M	2k	500M	10k
1µs	200M	2k	1G	10k	100M	1k	1G	10k
500ns	200M	1k	2G	10k	100M	500	2G	10k
200ns	200M	400	5G	10k	100M	200	5G	10k
100ns	200M	200	10G	10k	100M	100	10G	10k
50ns	200M	100	20G	10k	20G	10k	20G	10k
20ns	50G	10k	50G	10k	50G	10k	50G	10k
10ns	50G	5k	50G	5k	50G	5k	50G	5k
5ns	50G	2.5k	50G	2.5k	50G	2.5k	50G	2.5k
2ns	50G	1k	50G	1k	50G	1k	50G	1k

*1 When the envelope mode is ON, the maximum and minimum are displayed as pairs.

*2 For the settings enclosed by the bold lines, repetitive sampling is active.

Appendix 1 Relationship between the Time Axis Setting, Sample Rate and Record Length

Record length: 100 kwords

When envelope mode is ON, set at 200 MS/s (When the high-resolution mode is ON, 100 M/s)

Rep: Repetitive sampling mode

Setting T/div	When a mode other than the envelope mode is ON							
	Standard resolution				High resolution			
	Rep: OFF		Rep: ON		Rep: OFF		Rep: ON	
	Sample rate (S/s)	Displayed record length (words)	Sample rate (S/s)	Displayed record length (words)	Sample rate (S/s)	Displayed record length (words)	Sample rate (S/s)	Displayed record length (words)
500s	20	100k	20	100k	20	100k	20	100k
200s	50	100k	50	100k	50	100k	50	100k
100s	100	100k	100	100k	100	100k	100	100k
50s	200	100k	200	100k	200	100k	200	100k
20s	500	100k	500	100k	500	100k	500	100k
10s	1k	100k	1k	100k	1k	100k	1k	100k
5s	2k	100k	2k	100k	2k	100k	2k	100k
2s	5k	100k	5k	100k	5k	100k	5k	100k
1s	10k	100k	10k	100k	10k	100k	10k	100k
500ms	20k	100k	20k	100k	20k	100k	20k	100k
200ms	50k	100k	50k	100k	50k	100k	50k	100k
100ms	100k	100k	100k	100k	100k	100k	100k	100k
50ms	200k	100k	200k	100k	200k	100k	200k	100k
20ms	500k	100k	500k	100k	500k	100k	500k	100k
10ms	1M	100k	1M	100k	1M	100k	1M	100k
5ms	2M	100k	2M	100k	2M	100k	2M	100k
2ms	5M	100k	5M	100k	5M	100k	5M	100k
1ms	10M	100k	10M	100k	10M	100k	10M	100k
500µs	20M	100k	20M	100k	20M	100k	20M	100k
200µs	50M	100k	50M	100k	50M	100k	50M	100k
100µs	100M	100k	100M	100k	100M	100k	100M	100k
50µs	200M	100k	200M	100k	100M	50k	200M	100k
20µs	200M	40k	500M	100k	100M	20k	500M	100k
10µs	200M	20k	1G	100k	100M	10k	1G	100k
5µs	200M	10k	2G	100k	100M	5k	2G	100k
2µs	200M	4k	5G	100k	100M	2k	5G	100k
1µs	200M	2k	10G	100k	100M	1k	10G	100k
500ns	200M	1k	20G	100k	100M	500	20G	100k
200ns	200M	400	50G	100k	100M	200	50G	100k
100ns	200M	200	50G	50k	100M	100	50G	50k
50ns	200M	100	50G	25k	100M	25k	50G	25k
20ns	50G	10k	50G	10k	50G	10k	50G	10k
10ns	50G	5k	50G	5k	50G	5k	50G	5k
5ns	50G	2.5k	50G	2.5k	50G	2.5k	50G	2.5k
2ns	50G	1k	50G	1k	50G	1k	50G	1k

*1 When the envelope mode is ON, the maximum and minimum are displayed as pairs.

*2 For the settings enclosed by the bold lines, repetitive sampling is active.

Appendix 1 Relationship between the Time Axis Setting, Sample Rate and Record Length

Record length: 1 Mword

When envelope mode is ON, set at 200 MS/s (When the high-resolution mode is ON, 100 M/s)

Rep: Repetitive sampling mode

Setting T/div	When a mode other than the envelope mode is ON							
	Standard resolution				High resolution			
	Rep: OFF		Rep: ON		Rep: OFF		Rep: ON	
	Sample rate (S/s)	Displayed record length (words)	Sample rate (S/s)	Displayed record length (words)	Sample rate (S/s)	Displayed record length (words)	Sample rate (S/s)	Displayed record length (words)
500s	200	1M	200	1M	200	1M	200	1M
200s	500	1M	500	1M	500	1M	500	1M
100s	1k	1M	1k	1M	1k	1M	1k	1M
50s	2k	1M	2k	1M	2k	1M	2k	1M
20s	5k	1M	5k	1M	5k	1M	5k	1M
10s	10k	1M	10k	1M	10k	1M	10k	1M
5s	20k	1M	20k	1M	20k	1M	20k	1M
2s	50k	1M	50k	1M	50k	1M	50k	1M
1s	100k	1M	100k	1M	100k	1M	100k	1M
500ms	200k	1M	200k	1M	200k	1M	200k	1M
200ms	500k	1M	500k	1M	500k	1M	500k	1M
100ms	1M	1M	1M	1M	1M	1M	1M	1M
50ms	2M	1M	2M	1M	2M	1M	2M	1M
20ms	5M	1M	5M	1M	5M	1M	5M	1M
10ms	10M	1M	10M	1M	10M	1M	10M	1M
5ms	20M	1M	20M	1M	20M	1M	20M	1M
2ms	50M	1M	50M	1M	50M	1M	50M	1M
1ms	100M	1M	100M	1M	100M	1M	100M	1M
500μs	200M	1M	200M	1M	100M	500k	100M	500k
200μs	200M	400k	200M	400k	100M	200k	100M	200k
100μs	200M	200k	200M	200k	100M	100k	100M	100k
50μs	200M	100k	200M	100k	100M	50k	200M	100k
20μs	200M	40k	500M	100k	100M	20k	500M	100k
10μs	200M	20k	1G	100k	100M	10k	1G	100k
5μs	200M	10k	2G	100k	100M	5k	2G	100k
2μs	200M	4k	5G	100k	100M	2k	5G	100k
1μs	200M	2k	10G	100k	100M	1k	10G	100k
500ns	200M	1k	20G	100k	100M	500	20G	100k
200ns	200M	400	50G	100k	100M	200	50G	100k
100ns	200M	200	50G	50k	100M	100	50G	50k
50ns	200M	100	50G	25k	50G	25k	50G	25k
20ns	50G	10k	50G	10k	50G	10k	50G	10k
10ns	50G	5k	50G	5k	50G	5k	50G	5k
5ns	50G	2.5k	50G	2.5k	50G	2.5k	50G	2.5k
2ns	50G	1k	50G	1k	50G	1k	50G	1k

*1 When the envelope mode is ON, the maximum and minimum are displayed as pairs.

*2 For the settings enclosed by the bold lines, repetitive sampling is active.

Appendix 1 Relationship between the Time Axis Setting, Sample Rate and Record Length

Record length: 4 Mwords

When envelope mode is ON, set at 200 MS/s (When the high-resolution mode is ON, 100 M/s)

Rep: Repetitive sampling mode

Setting T/div	When a mode other than the envelope mode is ON							
	Standard resolution				High resolution			
	Rep: OFF		Rep: ON		Rep: OFF		Rep: ON	
	Sample rate (S/s)	Displayed record length (words)	Sample rate (S/s)	Displayed record length (words)	Sample rate (S/s)	Displayed record length (words)	Sample rate (S/s)	Displayed record length (words)
(800s)	500	4M	500	4M	500	4M	500	4M
500s	500	2.5M	500	2.5M	500	2.5M	500	2.5M
(400s)	1k	4M	1k	4M	1k	4M	1k	4M
200s	2k	4M	2k	4M	2k	4M	2k	4M
100s	2k	2M	2k	2M	2k	2M	2k	2M
(80s)	5k	4M	5k	4M	5k	4M	5k	4M
50s	5k	2.5M	5k	2.5M	5k	2.5M	5k	2.5M
(40s)	10k	4M	10k	4M	10k	4M	10k	4M
20s	20k	4M	20k	4M	20k	4M	20k	4M
10s	20k	2M	20k	2M	20k	2M	20k	2M
(8s)	50k	4M	50k	4M	50k	4M	50k	4M
5s	50k	2.5M	50k	2.5M	50k	2.5M	50k	2.5M
(4s)	100k	4M	100k	4M	100k	4M	100k	4M
2s	200k	4M	200k	4M	200k	4M	200k	4M
1s	200k	2M	200k	2M	200k	2M	200k	2M
(800ms)	500k	4M	500k	4M	500k	4M	500k	4M
500ms	500k	2.5M	500k	2.5M	500k	2.5M	500k	2.5M
(400ms)	1M	4M	1M	4M	1M	4M	1M	4M
200ms	2M	4M	2M	4M	2M	4M	2M	4M
100ms	2M	2M	2M	2M	2M	2M	2M	2M
(80ms)	5M	4M	5M	4M	5M	4M	5M	4M
50ms	5M	2.5M	5M	2.5M	5M	2.5M	5M	2.5M
(40ms)	10M	4M	10M	4M	10M	4M	10M	4M
20ms	20M	4M	20M	4M	20M	4M	20M	4M
10ms	20M	2M	20M	2M	20M	2M	20M	2M
(8ms)	50M	4M	50M	4M	50M	4M	50M	4M
5ms	50M	2.5M	50M	2.5M	50M	2.5M	50M	2.5M
(4ms)	100M	4M	100M	4M	100M	4M	100M	4M
2ms	200M	4M	200M	4M	100M	2M	100M	2M
1ms	200M	2M	200M	2M	100M	1M	100M	1M
500µs	200M	1M	200M	1M	100M	500k	100M	500k
200µs	200M	400k	200M	400k	100M	200k	100M	200k
100µs	200M	200k	200M	200k	100M	100k	100M	100k
50µs	200M	100k	200M	100k	100M	50k	200M	100k
20µs	200M	40k	500M	100k	100M	20k	500M	100k
10µs	200M	20k	1G	100k	100M	10k	1G	100k
5µs	200M	10k	2G	100k	100M	5k	2G	100k
2µs	200M	4k	5G	100k	100M	2k	5G	100k
1µs	200M	2k	10G	100k	100M	1k	10G	100k
500ns	200M	1k	20G	100k	100M	500	20G	100k
200ns	200M	400	50G	100k	100M	200	50G	100k
100ns	200M	200	50G	50k	100M	100	50G	50k
50ns	200M	100	50G	25k	50G	25k	50G	25k
20ns	50G	10k	50G	10k	50G	10k	50G	10k
10ns	50G	5k	50G	5k	50G	5k	50G	5k
5ns	50G	2.5k	50G	2.5k	50G	2.5k	50G	2.5k
2ns	50G	1k	50G	1k	50G	1k	50G	1k

*1 When the envelope mode is ON, the maximum and minimum are displayed as pairs.

*2 For the settings enclosed by the bold lines, repetitive sampling is active.

Appendix 1 Relationship between the Time Axis Setting, Sample Rate and Record Length

Record length: 10 Mwords

When envelope mode is ON, set at 200 MS/s (When the high-resolution mode is ON, 100 M/s)

Rep: Repetitive sampling mode

Setting T/div	When a mode other than the envelope mode is ON							
	Standard resolution				High resolution			
	Rep: OFF		Rep: ON		Rep: OFF		Rep: ON	
	Sample rate (S/s)	Displayed record length (words)	Sample rate (S/s)	Displayed record length (words)	Sample rate (S/s)	Displayed record length (words)	Sample rate (S/s)	Displayed record length (words)
500s	2k	10M	2k	10M	2k	10M	2k	10M
200s	5k	10M	5k	10M	5k	10M	5k	10M
100s	10k	10M	10k	10M	10k	10M	10k	10M
50s	20k	10M	20k	10M	20k	10M	20k	10M
20s	50k	10M	50k	10M	50k	10M	50k	10M
10s	100k	10M	100k	10M	100k	10M	100k	10M
5s	200k	10M	200k	10M	200k	10M	200k	10M
2s	500k	10M	500k	10M	500k	10M	500k	10M
1s	1M	10M	1M	10M	1M	10M	1M	10M
500ms	2M	10M	2M	10M	2M	10M	2M	10M
200ms	5M	10M	5M	10M	5M	10M	5M	10M
100ms	10M	10M	10M	10M	10M	10M	10M	10M
50ms	20M	10M	20M	10M	20M	10M	20M	10M
20ms	50M	10M	50M	10M	50M	10M	50M	10M
10ms	100M	10M	100M	10M	100M	10M	100M	10M
5ms	200M	10M	200M	10M	100M	4M	100M	4M
2ms	200M	4M	200M	4M	100M	2M	100M	2M
1ms	200M	2M	200M	2M	100M	1M	100M	1M
500µs	200M	1M	200M	1M	100M	500k	100M	500k
200µs	200M	400k	200M	400k	100M	200k	100M	200k
100µs	200M	200k	200M	200k	100M	100k	100M	100k
50µs	200M	100k	200M	100k	100M	50k	200M	100k
20µs	200M	40k	500M	100k	100M	20k	500M	100k
10µs	200M	20k	1G	100k	100M	10k	1G	100k
5µs	200M	10k	2G	100k	100M	5k	2G	100k
2µs	200M	4k	5G	100k	100M	2k	5G	100k
1µs	200M	2k	10G	100k	100M	1k	10G	100k
500ns	200M	1k	20G	100k	100M	500	20G	100k
200ns	200M	400	50G	100k	100M	200	50G	100k
100ns	200M	200	50G	50k	100M	100	50G	50k
50ns	200M	100	50G	25k	50G	25k	50G	25k
20ns	50G	10k	50G	10k	50G	10k	50G	10k
10ns	50G	5k	50G	5k	50G	5k	50G	5k
5ns	50G	2.5k	50G	2.5k	50G	2.5k	50G	2.5k
2ns	50G	1k	50G	1k	50G	1k	50G	1k

*1 When the envelope mode is ON, the maximum and minimum are displayed as pairs.

*2 For the settings enclosed by the bold lines, repetitive sampling is active.

Appendix 1 Relationship between the Time Axis Setting, Sample Rate and Record Length

Record length: 32 Mwords (When the high-resolution mode is ON, 16 Mword)

When envelope mode is ON, set at 200 MS/s (When the high-resolution mode is ON, 100 M/s)

Rep: Repetitive sampling mode

Setting T/div	When a mode other than the envelope mode is ON							
	Standard resolution				High resolution			
	Rep: OFF		Rep: ON		Rep: OFF		Rep: ON	
	Sample rate (S/s)	Displayed record length (words)	Sample rate (S/s)	Displayed record length (words)	Sample rate (S/s)	Displayed record length (words)	Sample rate (S/s)	Displayed record length (words)
(800s)	–	–	–	–	2k	16M	2k	16M
(640s)	5k	32M	5k	32M	–	–	–	–
500s	5k	25M	5k	25M	2k	10M	2k	10M
(320s)	10k	32M	10k	32M	5k	16M	5k	16M
200s	10k	20M	10k	20M	5k	10M	5k	10M
(160s)	20k	32M	20k	32M	10k	16M	10k	16M
100s	20k	20M	20k	20M	10k	10M	10k	10M
(80s)	–	–	–	–	20k	16M	20k	16M
(64s)	50k	32M	50k	32M	–	–	–	–
50s	50k	25M	50k	25M	20k	10M	20k	10M
(32s)	100k	32M	100k	32M	50k	16M	50k	16M
20s	100k	20M	100k	20M	50k	10M	50k	10M
(16s)	200k	32M	200k	32M	100k	16M	100k	16M
10s	200k	20M	200k	20M	100k	10M	100k	10M
(8s)	–	–	–	–	200k	16M	200k	16M
(6.4s)	500k	32M	500k	32M	–	–	–	–
5s	500k	25M	500k	25M	200k	10M	200k	10M
(3.2s)	1M	32M	1M	32M	500k	16M	500k	16M
2s	1M	20M	1M	20M	500k	10M	500k	10M
(1.6s)	2M	32M	2M	32M	1M	16M	1M	16M
1s	2M	20M	2M	20M	1M	10M	1M	10M
(800ms)	–	–	–	–	2M	16M	2M	16M
(640ms)	5M	32M	5M	32M	–	–	–	–
500ms	5M	25M	5M	25M	2M	10M	2M	10M
(320ms)	10M	32M	10M	32M	5M	16M	5M	16M
200ms	10M	20M	10M	20M	5M	10M	5M	10M
(160ms)	20M	32M	20M	32M	10M	16M	10M	16M
100ms	20M	20M	20M	20M	10M	10M	10M	10M
(80ms)	–	–	–	–	20M	16M	20M	16M
(64ms)	50M	32M	50M	32M	–	–	–	–
50ms	50M	25M	50M	25M	20M	10M	20M	10M
(32ms)	100M	32M	100M	32M	50M	16M	50M	16M
20ms	100M	20M	100M	20M	50M	10M	50M	10M
(16ms)	200M	32M	200M	32M	100M	16M	100M	16M
10ms	200M	20M	200M	20M	100M	10M	100M	10M
5ms	200M	10M	200M	10M	100M	5M	100M	5M
2ms	200M	4M	200M	4M	100M	2M	100M	2M
1ms	200M	2M	200M	2M	100M	1M	100M	1M
500µs	200M	1M	200M	1M	100M	500k	100M	500k
200µs	200M	400k	200M	400k	100M	200k	100M	200k
100µs	200M	200k	200M	200k	100M	100k	100M	100k
50µs	200M	100k	200M	100k	100M	50k	200M	100k
20µs	200M	40k	500M	100k	100M	20k	500M	100k
10µs	200M	20k	1G	100k	100M	10k	1G	100k
5µs	200M	10k	2G	100k	100M	5k	2G	100k
2µs	200M	4k	5G	100k	100M	2k	5G	100k
1µs	200M	2k	10G	100k	100M	1k	10G	100k
500ns	200M	1k	20G	100k	100M	500	20G	100k
200ns	200M	400	50G	100k	100M	200	50G	100k
100ns	200M	200	50G	50k	100M	100	50G	50k
50ns	200M	100	50G	25k	50G	25k	50G	25k
20ns	50G	10k	50G	10k	50G	10k	50G	10k
10ns	50G	5k	50G	5k	50G	5k	50G	5k
5ns	50G	2.5k	50G	2.5k	50G	2.5k	50G	2.5k
2ns	50G	1k	50G	1k	50G	1k	50G	1k

*1 When the envelope mode is ON, the maximum and minimum are displayed as pairs.

*2 For the settings enclosed by the bold lines, repetitive sampling is active.

Appendix 2 How to Calculate the Area of a Waveform

Integ1TY

Total Area for Positive Side Only: S_1+S_2

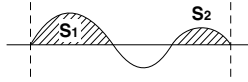

Integ2TY

Total Area for both Positive and Negative Sides: $S_1+S_3-S_2$

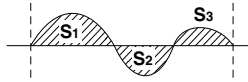

Integ1XY

(1) Multiple Loops

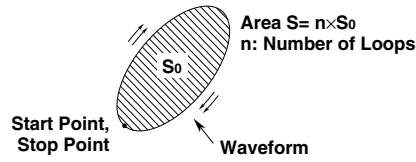

(2) Non-Closed Curve

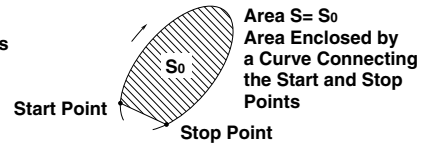

(3) Loop Tracing a Figure-Eight

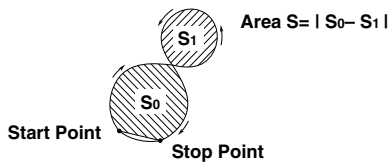

(4) Spiral Loop

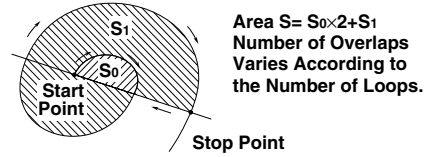

Integ2XY

(1) When Only One Y Data Corresponds to X Data

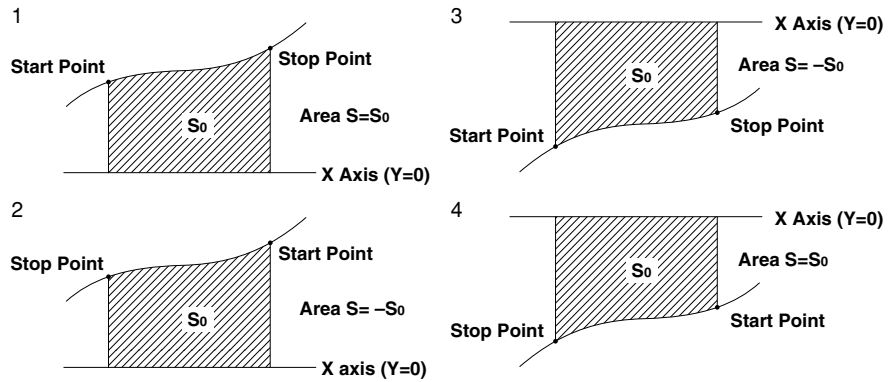

(2) When the Waveform Extends into the Negative Side

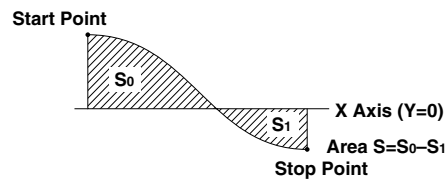

(2) When Two or more Y Data Correspond to X Data

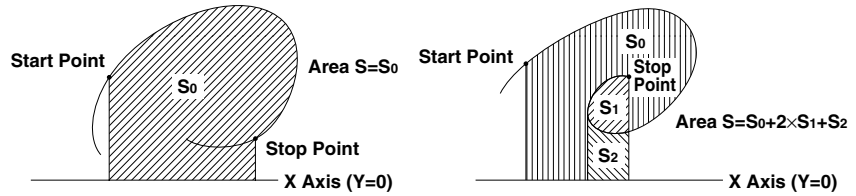

Appendix 3 ASCII Header File Format

//YOKOGAWA ASCII FILE FORMAT

\$PublicInfo

FormatVersion 1.11
Model DL1600
Endian Big
DataFormat TRACE
GroupNumber 3
TraceTotalNumber 10
DataOffset 0

\$Group1

TraceNumber	4			
BlockNumber	1			
TraceName	CH1	CH2	CH3	CH4
BlockSize	1002	1002	1002	1002
VResolution	1.5625000E+00	1.5625000E+00	1.5625000E+00	1.5625000E+00
VOffset	0.0000000E+00	0.0000000E+00	0.0000000E+00	0.0000000E+00
VDataType	IS2	IS2	IS2	IS2
VUnit	V	V	A	V
VPlusOverData	32767	32767	32767	32767
VMinusOverData	-32769	-32769	-32769	-32769
VIllegalData	32767	32767	32767	32767
VMaxData	32766	32766	32766	32766
VMinData	-32768	-32768	-32768	-32768
HResolution	5.0000000E-09	5.0000000E-09	5.0000000E-09	5.0000000E-09
HOffset	-2.5000000E-06	-2.5000000E-06	-2.5000000E-06	-2.5000000E-06
HUnit	s	s	s	s
Date	2001/07/25	2001/07/25	2001/07/25	2001/07/25
Time	01:45:00	01:45:00	01:45:00	01:45:00

Appendix 3 ASCII Header File Format

\$Group2				
TraceNumber	2			
BlockNumber	1			
TraceName	MATH1	MATH2		
BlockSize	1002	1002		
VResolution	6.1035156E-03	1.2207031E+00		
VOffset	-7.7000000E+01	2.0000000E+04		
VDataType	IS2	IS2		
VUnit	DB	V		
VPlusOverData	32767	32767		
VMinusOverData	-32769	-32769		
VIllegalData	32767	32767		
VMaxData	32766	32766		
VMinData	-32768	-32768		
HResolution	2.0000000E-01	5.0000000E-09		
HOffset	0.0000000E+00	-2.5000000E-06		
HUnit	Hz	s		
Date	2001/07/25	2001/07/25		
Time	01:45:00	01:45:00		
\$PrivateInfo				
DisplayBlockSize	10020	10020	10020	10020
DisplayPointNo.	1	1	1	1
ModelVersion	1.02			
PhaseShift	0	0	0	0

Note

The same header file format is used by all YOKOGAWA measuring instruments, so it may contain some data which is not necessary for the instrument.

- **\$Publicinfo (Common Information)**

FormatVersion: Version No. of header file format
 Model: Model name
 Endian: Endian mode (Big/Ltl)^{*1}
 DataFormat: Storage format (Trace / Block) of binary file waveform data^{*2}
 GroupNumber: Number of the \$Group
 TraceTotalNumber: Total number of selected waveforms
 DataOffset: Start position of binary file waveform data^{*3}

- **\$Group1 (Group Information)**

TraceNumber: Number of waveforms in the group
 BlockNumber: Number of blocks in the group^{*4}
 TraceName: Name of each waveform
 BlockSize: Data size of each block of waveform
 VResolution: Resolution coefficient of Y axis conversion equation for each waveform^{*5}
 VOffset: Offset coefficient of Y axis conversion equation for each waveform
 VDataType: Type of binary file waveform data for each waveform^{*6}
 VUnit: Units used for Y axis of each waveform (no effect on data)
 VPlusOverData: Data error occurs when binary data for a waveform exceeds this value.
 VMinusOverData: Data error occurs when binary data for a waveform is below this value.
 VMaxData: Maximum value of binary data for each waveform
 VMinData: Minimum value of binary data for each waveform
 HResolution: Resolution coefficient of X axis conversion equation for each waveform^{*7}
 HOffset: Offset coefficient of X axis conversion equation for each waveform
 HUnit: Units used for X axis for each waveform (no effect on data)
 Date: Date when waveform acquisition was completed
 Time: Time when waveform acquisition was completed
 For *1 to *7, see the next page.

- **\$PrivateInfo (Information Indigenous to Model)**

ModelVersion: Version No. of the model
 MathBlockNo.: Block No. of block to be computed
 FormMath1: Waveform for Math1 and its contents
 FormMath2: Waveform for Math2 and its contents
 DisplayBlockSize: Length of the data displayed on the screen (display record length)
 DisplayPointNo: Value which indicates which point of the memory is the left end of the display record length (display offset is 1 when record length = display record length)
 PhaseShift: Phase information (lead: -, delay: +)

* Calculation of the actual display offset of the phase-shifted waveform = DisplayPointNo. - PhaseShift

Creation of an ASCII Header File

When waveform data (Waveform) is stored on a floppy disk or a Zip disk, the following files will be created automatically in the DL_WAVE directory.

- Waveform data file (*.WVF)
- ASCII header file (*.HDR)

The waveform data file can be recalled to the instrument using the file menu, but the ASCII header file cannot; therefore it cannot be viewed on the instrument. However, it can be used when you analyze the waveform using a personal computer.

***1: Endian Mode for Storage**

Big: Data for Motorola 68000 series

Ltl: Data for Intel 86 series

***2: Binary File Storage Format**

Trace: Groups into blocks, each block for a single waveform.

Block: Groups into blocks, each block for a given time interval.

***3: Binary File Start Position**

Offset from the beginning of the file

***4: Maximum Number of Blocks per Group**

Maximum number of blocks applies if the number of blocks varies between waveforms.

***5: Y Axis Conversion Equation for Each Waveform**

Y axis value = VResolution x Raw data + VOffset

***6: Data Type**

ISn: n-byte signed integer

IUn: n-byte unsigned integer

FSn: n-byte signed real number

FUn: n-byte unsigned real number

Bm: m-byte data

***7: X Axis Conversion Equation for Each Waveform**

X axis value = HResolution x (Data No. -1) + HOffset

Appendix 4 List of Defaults

Menu Key	Soft Key	Default Setting
CH1 to 4		
	Display	ON
	Position	0 div
	Cupling	DC
	Probe	10:1
	Offset	0V
	Band Width	Full
	Invert	OFF
	Variable	50 V
	Linear Scale	OFF
	Label	CH1CH4
V/div		
		50 V
T/div		
		1 ms/div
PRESET		
	Select	All
	Type	CMOS (5 V)
	Prove	10 : 1
ACQ		
	Record Length	10 k
	Mode	Normal
	Count	Infinite
	Repetitive	OFF
	Hi-Res Mode	OFF
	Time Base	Int
TRIGGER		
	SIMPLE	
	Source	CH1
	Level	0V
	Slope	Rise
	Coupling	DC
	HF Rejection	OFF
	Histeresis	✓
	Hold Off	0.08 μs
HISTORY		
	Select Record	0
	Display Mode	One
	Start Record	0
	End Record	latest
	Show Map No.	1
	Search Mode	OFF
FILE		
	File Item	Set up
	File Name	
	Auto Naming	ON
COPY(MENU)		
	Copy to	Built-in
	Format	Normal
	Information	OFF
IMAGE SAVE (MENU)		
	Format	TIFF
	Color	OFF
	File Name	
	Auto Naming	ON

Menu Key	Soft Key	Default Setting
MEASURE		
	Mode	OFF
	Item Setup	
	Source	CH1
	Item	OFF
	Dual Area	OFF
	Delay Setup	
	Source	CH1
	Mode	OFF
	1 cycle mode	OFF
	Time Range 1	-5 div
	Time Range 2	5 div
	Trace	CH1
	Distal	90%
	Mesial	50%
	Proximal	10%
	High/Low Mode	AUTO
CURSOR		
	Type	OFF
MATH		
	M1 Display	OFF
	M1 Setup	C1+C2
	M1 Label	Math1
	M2 Display	OFF
	M2 Setup	C3+C4
	M2 Label	Math2
DISPLAY		
	Format	Quad
	Interpolation	Sin
	Graticule	Grid
	Mapping	Auto
	Translucent	OFF
	Scale Value	OFF
	Trace Label	OFF
	Accumulate	OFF
ZOOM		
	Mode	Main
POSITON		
	Position	50%
DELAY		
	Delay	0 S
GO/NO-GO		
	Mode	OFF
SEARCH		
	Type	Edge
	Z1 Mag	×2
	Z position	0 div
ACTION		
	Buzzer	OFF
	Save to File	OFF
	Hard Copy	OFF
	Image Save	OFF
	ACQ Count	Infinite
	Send Mail	OFF
	Mail Count	100

Appendix 5 Assignment of Keys on the USB Keyboard

104 Keyboard (US)

Key	When Pressed with the Control Key		When the Soft Keyboard Is Displayed		Other	
		+Shift Operation		+Shift Operation		+Shift Operation
a	ACQ menu	Same as left	a	A		
b	MATH menu	Same as left	b	B		
c	COPY	Same as left	c	C		
d	DISPLAY menu	Same as left	d	D		
e	ENHANCED menu	Same as left	e	E		
f	FILE menu	Same as left	f	F		
g	GO/NOGO menu	Same as left	g	G		
h	HISTORY menu	Same as left	h	H		
i	IMAGE SAVE execution	Same as left	i	I		
j	PRESET menu	Same as left	j	J		
k			k	K		
l			l	L		
m	MEASURE menu	Same as left	m	M		
n			n	N		
o			o	O		
p	POSITION menu	Same as left	p	P		
q	CLEAR TRACE	Same as left	q	Q		
r	RESET	Same as left	r	R		
s	SHIFT condition	Same as left	s	S		
t	TRIGMODE menu	Same as left	t	T		
u	CURSOR menu	Same as left	u	U		
v			v	V		
w	SIMPLE menu	Same as left	w	W		
x			x	X		
y			y	Y		
z	ZOOM menu	Same as left	z	Z		
1	CH1 menu		1	!		
2	CH2 menu		2	@		
3	CH3 menu		3	#		
4	CH4 menu		4	\$		
5			5	%		
6			6	^		
7			7	&		
8			8	*		
9			9	(
0			0)		
Enter	Return (Enter), Select	Same as left	Return (Enter)	Same as left		
Esc	Escape	Same as left	Escape	Same as left		
Back Space			Back Space	Same as left		
Tab						
Space Bar			Space Bar	Same as left		
-			-	_		
=			=	+		
[[{		
]]	}		
\	SETUP	Same as left	\			
;			;	:		
'			'	"		
,			,	<		
.			.	>		
/	MISC menu	HELP	/	?		
Caps Lock			Caps Lock	Same as left		

Appendix 5 Assignment of Keys on the USB Keyboard

F1	Select Soft key1	Same as left	Select Soft key1	Same as left	Select Soft key1	Same as left
F2	Select Soft key2	Same as left	Select Soft key2	Same as left	Select Soft key2	Same as left
F3	Select Soft key3	Same as left	Select Soft key3	Same as left	Select Soft key3	Same as left
F4	Select Soft key4	Same as left	Select Soft key4	Same as left	Select Soft key4	Same as left
F5	Select Soft key5	Same as left	Select Soft key5	Same as left	Select Soft key5	Same as left
F6	Select Soft key6	Same as left	Select Soft key6	Same as left	Select Soft key6	Same as left
F7	Select Soft key7	Same as left	Select Soft key7	Same as left	Select Soft key7	Same as left
F8	Escape	Same as left	Escape	Same as left	Escape	Same as left
F9						
F10						
F11			μ	Same as left		
F12	START/STOP	Same as left	Ω	Same as left	START/STOP	Same as left
Print Screen	COPY	Same as left				
Scroll Lock	IMAGE SAVE	Same as left				
Pause	SNAPSHOT	Same as left				
Insert			Insert mode	Same as left		
Home	Increment V/Div	Same as left			Increment V/Div	Same as left
Page Up	Increment T/Div	Same as left			Increment T/Div	Same as left
Delete			Delete	Same as left		
End	Decrement V/Div	Same as left			Decrement V/Div	Same as left
Page Down	Decrement T/Div	Same as left			Decrement T/Div	Same as left
→	Cursor to the right	Same as left	Cursor to the right	Same as left	Cursor to the right	Same as left
←	Cursor to the left	Same as left	Cursor to the left	Same as left	Cursor to the left	Same as left
↓	Jogshuttle down	Same as left	Select Soft key6	Same as left	Jogshuttle down	Same as left
↑	Jogshuttle up	Same as left	Select Soft key6	Same as left	Jogshuttle up	Same as left
Numeric						
Num Lock						
/			/	Same as left		
*	START/STOP	Same as left	*	Same as left	START/STOP	Same as left
-			-	Same as left		
+			+	Same as left		
Enter			Return (Enter)	Same as left	Return (Enter),Select	Same as left
1	CH1 menu	Decrement V/Div	1			Decrement V/Div
2	CH2 menu	Jogshuttle down	2			Jogshuttle down
3	CH3 menu	Decrement T/Div	3			Decrement T/Div
4	CH4 menu	Cursor to the left	4			Cursor to the left
5			5			
6		Cursor to the right	6			Cursor to the right
7		Increment V/Div	7			Increment V/Div
8		Jogshuttle up	8			Jogshuttle up
9		Increment T/Div	9			Increment T/Div
0			0	Insert mode		
.			.	DELETE		

Appendix 5 Assignment of Keys on the USB Keyboard

109 Keyboard (Japanese)

Key	When Pressed with the Control Key		When the Soft Keyboard Is Displayed		Other	
		+Shift Operation		+Shift Operation		+Shift Operation
a	ACQ menu	Same as left	a	A		
b	MATH menu	Same as left	b	B		
c	COPY	Same as left	c	C		
d	DISPLAY menu	Same as left	d	D		
e	ENHANCED menu	Same as left	e	E		
f	FILE menu	Same as left	f	F		
g	GO/NOGO menu	Same as left	g	G		
h	HISTORY menu	Same as left	h	H		
i	IMAGE SAVE execution	Same as left	i	I		
j	PRESET menu	Same as left	j	J		
k			k	K		
l			l	L		
m	MEASURE menu	Same as left	m	M		
n			n	N		
o			o	O		
p	POSITION menu	Same as left	p	P		
q	CLEAR TRACE	Same as left	q	Q		
r	RESET	Same as left	r	R		
s	SHIFT condition	Same as left	s	S		
t	TRIGMODE menu	Same as left	t	T		
u	CURSOR menu	Same as left	u	U		
v			v	V		
w	SIMPLE menu	Same as left	w	W		
x			x	X		
y			y	Y		
z	ZOOM menu	Same as left	z	Z		
1	CH1 menu		1	!		
2	CH2 menu		2	"		
3	CH3 menu		3	#		
4	CH4 menu		4	\$		
5			5	%		
6			6	&		
7			7	'		
8			8	(
9			9)		
0			0			
Enter	Return (Enter), Select	Same as left	Return (Enter)	Same as left		
Esc	Escape	Same as left	Escape	Same as left		
Back Space			Back Space	Same as left		
Tab						
Space Bar			Space Bar	Same as left		
-			-	=		
^			^	~		
@			@	`		
[[{		
;			;	+		
:			:	*		
]]	}		
,			,	<		
.			.	>		
/	MISC menu	HELP	/	?		
Caps Lock			Caps Lock	Same as left		

Appendix 5 Assignment of Keys on the USB Keyboard

F1	Select Soft key1	Same as left	Select Soft key1	Same as left	Select Soft key1	Same as left
F2	Select Soft key2	Same as left	Select Soft key2	Same as left	Select Soft key2	Same as left
F3	Select Soft key3	Same as left	Select Soft key3	Same as left	Select Soft key3	Same as left
F4	Select Soft key4	Same as left	Select Soft key4	Same as left	Select Soft key4	Same as left
F5	Select Soft key5	Same as left	Select Soft key5	Same as left	Select Soft key5	Same as left
F6	Select Soft key6	Same as left	Select Soft key6	Same as left	Select Soft key6	Same as left
F7	Select Soft key7	Same as left	Select Soft key7	Same as left	Select Soft key7	Same as left
F8	Escape	Same as left	Escape	Same as left	Escape	Same as left
F9						
F10						
F11			μ	Same as left		
F12	START/STOP	Same as left	Ω	Same as left	START/STOP	Same as left
Print Screen	COPY	Same as left				
Scroll Lock	IMAGE SAVE	Same as left				
Pause	SNAPSHOT	Same as left				
Insert			Insert mode	Same as left		
Home	Increment V/Div	Same as left			Increment V/Div	Same as left
Page Up	Increment T/Div	Same as left			Increment T/Div	Same as left
Delete			Delete	Same as left		
End	Decrement V/Div	Same as left			Decrement V/Div	Same as left
Page Down	Decrement T/Div	Same as left			Decrement T/Div	Same as left
→	Cursor to the right	Same as left	Cursor to the right	Same as left	Cursor to the right	Same as left
←	Cursor to the left	Same as left	Cursor to the left	Same as left	Cursor to the left	Same as left
↓	Jogshuttle down	Same as left	Select Soft key6	Same as left	Jogshuttle down	Same as left
↑	Jogshuttle up	Same as left	Select Soft key6	Same as left	Jogshuttle up	Same as left
\	SETUP menu	Same as left	\			
\			\	-		
Numeric key						
Num Lock						
/			/	Same as left		
*	START/STOP	Same as left	*	Same as left	START/STOP	Same as left
-			-	Same as left		
+			+	Same as left		
Enter			Return (Enter)	Same as left	Return (Enter), Select	Same as left
1	CH1 menu	Decrement V/Div	1			Decrement V/Div
2	CH2 menu	Jogshuttle down	2			Jogshuttle down
3	CH3 menu	Decrement T/Div	3			Decrement T/Div
4	CH4 menu	Cursor to the left	4			Cursor to the left
5			5			
6		Cursor to the right	6			Cursor to the right
7		Increment V/Div	7			Increment V/Div
8		Jogshuttle up	8			Jogshuttle up
9		Increment T/Div	9			Increment T/Div
0			0	Insert mode		
.		DELETE prev. char	.	DELETE		

Index

Symbols

	Page
< > keys	2-5
1 Cycle Mode	9-20
104 keyboard	4-4
104 Keyboard (US)	App-20
109 keyboard	4-4
109 Keyboard (Japanese)	App-22

A

	Page
A -> B(N) Trigger	1-8, 6-14
A Delay B Trigger	1-9, 6-17
Accumulate Mode	8-10
Accumulated Waveform Display	1-16
Accumulation Period	8-10
Accuracy Test	15-10
ACQ Key	2-5
Acquisition Mode	1-15, 7-2
Action Mail Function	13-19
Action-On Trigger	1-11, 6-39
Adding	9-35
Addition	1-24
Angle Cursor	1-21, 9-4
Arrow Keys	2-5
ASCII	11-15
ASCII Header File Format	App-15
Attached Image File	13-16
Attaching image files	13-17
Auto Cal	4-20
Auto Calibration	4-20
Auto Level Mode	1-11, 6-1
Auto Measurement Mode	9-17
Auto Mode	1-11, 6-1
Auto Naming Function	10-13, 11-16, 11-21
Auto Scroll	1-29, 8-28
Auto Scroll Search	8-27
Auto Setup	1-32, 4-13
Automated Measurement Mode	9-32
Automated Measurement of Waveform Parameters	9-14
Automated Measurements	1-22, 9-28
Auxiliary Input/Output Section	16-8
Average	7-3
Averaging Mode	1-15

B

	Page
Backlight	14-6
Bandwidth	5-11
Bandwidth Limit	1-7

Binary	11-15
Binary File	App-18
Binary Format	11-15
Block Diagram	1-1
Brightness	14-1
Built-in Printer	10-1, 10-3, 16-6
Built-in Storage	16-7
Buzzer (Action)	6-40, 9-48, 9-53

C

	Page
Calibration	4-19
Canceling the Offset Voltage	14-8
Changing the Directory/File Name	11-41
Changing the File Attributes	11-33
Checking the System Condition	15-11
Clear Trace	1-33, 4-18
CLEAR TRACE Key	2-5
Click Sound	14-4, 14-5
Comment	13-17
Compensating the Probe	3-12
Compressed Images	11-36, 11-40, 11-44
Computer Interface	16-9
Connecting a Probe	3-9
Contents of the Package	iii
Control script	13-28, 13-46
COPY Key	2-4
Copying Files	11-37
Coupling	5-5
Creating a Directory	11-41
Current Probe	v, 3-10, 5-10
Cursor	9-1
Cursor Jump	9-7
CURSORS Key	2-4
Cursor Measurement	1-21

D

	Page
Data capture	13-28, 13-37
Data Control	13-39
Data Search	1-26
Date	3-14
Default Gateway	13-5
Degree (Cursor Measurement)	1-21
Degree (Cursor)	9-4
Delay	9-15, 9-19
Delay (Trigger)	1-13
Delay Time	1-13, 6-19
Deleting Files	11-33
Deskew	4-20

Index

DHCP	13-6
Differential Probe	v, 3-10
Display	16-4
Display Format	1-17
Display Interpolation	1-18
DISPLAY Key	2-4
Display Settings	1-17
Displayed Data Output Functions	1-34
Distal	9-17, 9-32
DNS	13-6
DNS Server	13-6
Domain Suffix	13-6
Dual Area Measurement Mode	9-33
Dual Areas	1-23, 9-28

E

Page

Edge	8-28
Edge Search	1-26, 8-17
Edge Trigger	1-8, 6-8
Effective Data Range	1-5
ENHANCED Key	2-3
Enhanced Trigger	1-8
Entering a Character String	4-2
Entering a Value	4-1
Entering Numerical Values	4-5
Envelope	7-3
Envelope Mode	1-15
Error in Execution	15-3
Error in Setting	15-5
Error Messages	15-2
Ethernet Interface	1-30, 13-1, 16-9
Expanded Waveform	1-19
External Clock Input	12-1
External Dimensions	16-12
External Trigger	6-11
External Trigger Input	12-1, 16-8

F

Page

FET Probe	v
FFT (Fast Fourier Transform) Computation	1-25
FFT Function	1-25
Field No.	6-36
FILE Key	2-4
Fixed Interval	13-16
Float	11-15
Floppy Disk Drive	1-34, 16-7
Floppy Disk Drive Test	15-10
Floppy Disks	11-1
Formatting a Floppy Disk	11-9
Formatting a Zip Disk	11-10
Formatting the Storage Medium	11-7
Frame Skip	6-38
Frequency Characteristic	5-5

Front Panel	2-1
FTP Client Function	1-30, 13-8, 13-11
FTP Passive Mode	13-25
FTP Server	13-10, 13-13
FTP Server Function	1-30, 13-21

G

Page

Generating Triggers on the Power Signal	6-13
GO OUT	16-8
GO OUT Signal	9-54
GO/NO-GO Determination	1-33
GO/NO-GO Determination (Parameter)	9-45
GO/NO-GO Determination (Zone)	9-49
GO/NO-GO Key	2-4
GO/NO-GO Output	16-8
GO/NO-GO Signal Output	9-54
GP-IB Interface	16-9
Grade Width	8-10
Graticule	1-17, 8-5

H

Page

H & V Cursor	1-21
H Cursor	1-21, 9-1, 9-8
H&V Cursor	9-5
Hard Copy (Action)	6-40, 9-48, 9-53
Help Function	4-21
HELP Key	2-5
Help Window	4-21
HF Rejection	1-12, 6-9, 6-16, 6-19, 6-23, 6-28, 6-31, 6-34
Hi-Res	7-6
High Level	12-4
high-resolution mode	1-14, 4-14, 5-19, 7-6, 16-1
Historical data V cursors	9-6
HISTORY Key	2-5
History Memory	1-17, 7-8
History Memory Search Using Waveform Parameters	1-26
History Memory Search Using Zone	1-26
History Search Function	1-26, 7-11, 7-15
Hold Off Time	6-6
Horizontal (Cursor Measurement)	1-21
Horizontal (Cursor)	9-1, 9-8
Horizontal Axes	1-3
HORIZONTAL Group	2-3
How to Calculate the Area of a Waveform	App-13
Hysteresis	6-10, 6-16, 6-19, 6-22, 6-28, 6-31

I

Page

Image Control	13-38
Image Save (Action)	6-40, 9-48, 9-53
IMAGE SAVE Key	2-4
Information	13-28, 13-50
Initialization	1-32

Initializing	4-11
Input Coupling	1-6, 5-4
Input Section	16-1
Input Terminals	3-9
Installation Conditions	3-3
Installation Position	3-4
Instrument Control	13-40
Instrument Number	iv
internal flash memory	1-34
Interpolate	8-3
Interpolation Method	8-3
Interval	13-17
IP Address	13-5

J **Page**

Jog and Shuttle Dials	2-5
Jog Shuttle	2-3

K **Page**

Key Test	15-10
Keyboard and Printer Interface	16-7
Keyboard Operation	4-2
Knobs	2-3

L **Page**

Line Interpolation	1-18
Line No.	6-37
Linear Scaling	1-21, 5-15, 5-16
Link	13-28, 13-51
List of Defaults	App-19
Loading Setup Data	11-18
Loading Snapshot Waveforms	11-24
Loading Waveform Data	11-11
Log	13-28, 13-48
Login Name	13-10, 13-13
Low Level	12-4
LPR Client Function	1-30, 13-14
LPR Server	13-15
LPR Timeout	13-25

M **Page**

MAC Address	13-23
Mail Address	13-17
Mail Function	13-16, 13-19
Mail Server	13-17
Mail Settings	13-17, 13-20
Mail Transmission	1-31
MailBaseTime	13-17
Main Power Switch	3-6
Mapping	8-2

Marker Cursor	1-21, 9-3, 9-9
Markers (Cursor Measurement)	1-21
MATH Key	2-4
MEASURE Key	2-4
Measurement Resolution	1-5
Measurement trend	13-42
Memory Test	15-10
Mesial	9-17, 9-32
Message Language	14-4, 14-5
MISC Key	2-4
MODE Key	2-3
MODEL	iii
Multiplication	1-24
Multiplying	9-35

N **Page**

network drive	13-53
No Interpolation	1-18
NO-GO OUT	16-8
NO-GO OUT Signal	9-54
Normal (Acquisition Mode)	7-3
Normal Mode	6-1
Normal Mode (Acquisition Mode)	1-15
Normal Mode (Trigger Mode)	1-11
Normal Statistical Processing	1-22, 9-26
NTSC	1-10, 6-37

O **Page**

Offset	5-16
Offset Voltage	1-6, 5-7, 5-8
One-to-One Connection	13-2
Operation Keys	2-3
Optional Accessories	v
Optional Spare Parts	v
Options	iii
OR Trigger	1-10, 6-29
Outputting to a Network Printer	1-30
Overview	15-11

P **Page**

P-P Compression	11-16
PAL	6-37, 6-38
Parallel Pattern	8-28
Parallel Pattern Search	1-27, 8-22
Password	13-10, 13-13, 13-22
Pattern Trigger	1-9, 6-20
PC Card	1-34, 16-7
PC Card Drive Test	15-10
Phase Correction	3-12
Phase-Shifted	1-24
Phase-Shifted Display	9-44
Polarity	6-38

Index

POSITION Key	2-3
Power Connectors for the Probes	16-8
Power Cord	iii, iv, 3-5
Power Spectrum	9-38
Power Spectrum Display	1-25
Power Switch	3-7
Precautions During Use	3-1
Preset	1-33
Preset Function	5-9
PRESET Key	2-3
Preview	10-5
Printer Format	13-15
Printer Name	13-15
Printer Roll Chart	10-1
Printer Test	15-10
PRN/KBD Terminal	10-8
Probe	3-10
Probe Attenuation	1-7, 5-6, 6-12
Protective Grounding	vii
Proximal	9-17, 9-32
Pulse Interpolation	1-18
Pulse Width	8-28
Pulse Width Search	1-28, 8-24
Pulse Width Trigger	1-9

R

Page

Real-Time Sampling Mode	1-4
Rear Panel	2-1
Recalling	1-32, 4-15
Recommended Replacement Parts	15-13
Record Length	1-4, 1-14, 7-1, App-1
Repetitive Sampling Mode	1-4, 7-7
RESET Key	2-5
RGB VIDEO OUT	12-5, 16-8
RGB Video Signal Output	12-5, 16-8
Roll Mode	5-20
Roll Mode Display	1-4
RS-232 Interface	16-9

S

Page

Sample Rate	1-4, App-1
Sampling Mode	1-4, 1-16, 5-19
Save to File (Action)	6-40, 9-48, 9-53
Saving Setup Data	11-18
Saving Snapshot Waveforms	11-23
Saving the Results of the Automated Measurement	11-27, 11-30
Saving to a Network Drive	1-30
Saving Waveform Data	11-11
Scale Values	1-17
Scaling	1-24
Scaling Coefficient	5-16
Scaling Value	8-6

Screen Color	14-1
Screens	2-6
SCSI Interface	16-7
Search and Zoom Function	1-26, 8-17
Searching the Historical Data Using Parameters	7-15
Searching the Historical Data Using Zone	7-11
SECAM	6-37
SELECT Key	2-5
Self Test	15-8
Self-Diagnostic Test	15-8
Send Mail (Action)	6-40, 9-48, 9-53
Sending a Test Mail	13-17
Sequential Store	1-16, 7-5
Serial Interface	16-9
Serial Number	iii
Serial Pattern	8-28
Serial Pattern Search	1-27, 8-19
Settings for a Network Printer	13-15
SETUP Key	2-4
SHIFT Key	2-4
Show Map	7-10, 7-14, 7-18
SIMPLE Key	2-3
Simple Trigger	1-8
Sine Interpolation	1-18
Single (N) Mode	1-11, 6-2
Single Mode	1-11, 6-2
Smoothing	9-42
SMTP Client Function	1-31
SMTP Timeout	13-25
SNAP SHOT Key	2-5
Snapshot	1-33, 4-18, 11-23
SNTP	3-15, 13-27
Soft Keys	2-5
SPECIFICATIONS	iii
Standard Accessories	iv
START/STOP Key	2-5
Statistical Processing	1-22, 9-21
Statistical Processing for Each Period	1-23, 9-26
Statistical Processing of Historical Data	1-21, 1-23, 9-26
Status Messages	15-2
Storage	16-7
Storage Medium	10-10
Storage Medium Saves and Loads	1-34
Storing	1-32, 4-15
STP (shielded twisted-pair) Cable	13-1
Subnet Mask	13-5
Subtracting	9-35
Subtraction	1-24
SUFFIX	iii
System Configuration	1-1
System Operation Errors	15-7

T	Page		
T/div	5-19	Vertical (Cursor)	9-2, 9-8
TCP/IP	13-3	Vertical History	1-21
Threshold Level	12-2	Vertical Position	1-5, 5-2
Threshold Setting	5-17	Vertical Sensitivity	1-5
Thumbnail	10-14	Video Signal	1-10, 6-36
Thumbnail Window	10-14		
Time	3-14	W	Page
Time Axis	1-3, 16-4, App-1	Waveform Acquisition	4-17
Time Out	13-10, 13-13, 13-22	Waveform Label	1-18, 8-8
TIME/DIV Knob	2-3	Waveform Math	1-24
Timebase	1-3, 5-17	Web Server Function	1-31
Translucent Mode	8-11	Web server function	13-28
Trend	13-28	WebDAV	13-53
TRG'D Indicator	2-3	Width Trigger	6-24
TRIG OUT	12-3, 16-8	Window Trigger	1-10, 6-32
Trigger	1-8		
Trigger Condition	6-22	X	Page
Trigger Coupling .. 1-11, 6-9, 6-16, 6-19, 6-23, 6-28, 6-31, 6-34		X-Y Waveform	1-19, 8-12
Trigger Delay	1-13, 6-3		
TRIGGER Group	2-3	Z	Page
Trigger Hold-Off	1-12	Zip Disks	11-2
Trigger Hysteresis	1-12	Zip Drive	1-34, 16-7
Trigger Level		Zip Drive Test	15-10
..... 1-12, 6-9, 6-12, 6-16, 6-19, 6-22, 6-28, 6-31, 6-38		Zoom	1-19
Trigger Mode	1-11, 6-1	ZOOM Key	2-3
Trigger Output	12-3, 16-8	Zooming the Waveform	8-14
Trigger Position	1-13, 6-4		
Trigger Section	16-2		
Trigger Slope	6-9, 6-12		
Trigger Source	1-12, 6-9, 6-12, 6-13, 6-22		
Trigger Type	1-8		
Troubleshooting	15-1		
Turning Channels ON/OFF	5-1		
TV Trigger	1-10, 6-35		
U	Page		
USB Interface	16-9		
USB Keyboard	1-32, 4-3, App-20		
USB Printer	1-34, 10-6		
USB storage	11-5, 11-6		
User Account Settings	13-22		
User Name	13-22		
User Preset	5-10		
UTP (unshielded twisted-pair) Cable	13-1		
V	Page		
V Cursor	1-21, 9-2, 9-8		
V/div	5-12		
V/DIV Knob	2-3		
Variable Parameter	5-13		
Vertical	1-3		
Vertical (Cursor Measurement)	1-21		